

Real Time Clock Module with I²C Bus

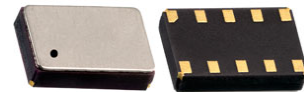

3.7 x 2.5 x 0.9 mm

AB-RTCMC-32.768kHz-B5ZE-S3



RoHS/RoHS II compliant

Moisture Sensitivity Level: MSL=1

FEATURES:

- RTC module with built-in crystal oscillating at 32.768 kHz
- 1 MHz Fast-mode Plus (Fm+) two-wire I2C interface
- Wide Interface operating voltage: 1.6 – 5.5 V
- Wide clock operating voltage: 1.2 – 5.5 V
- Ultra low power consumption: 130 nA typ @ 3.0V / 25°C
- Provides year, month, day, weekday, hours, minutes, seconds
- Freely programmable Alarm and Timer functions with interrupt capability
- Low voltage detector, internal power on reset
- Battery backup input pin and switch-over circuit
- INT_1 can be programmed either as interrupt or clock output (open-drain)
- Programmable clock output for peripheral devices (32.768 kHz, 16.384 kHz, 8192 Hz, 4096 Hz, 1024 Hz, 32 Hz and 1 Hz)
- Programmable offset register for frequency adjustment
- I2C slave address: read D1h, write D0h
- Small and compact package size: 3.7 x 2.5 x 0.9 mm. RoHS-compliant and 100% leadfree

APPLICATIONS:

- Wide range in communication & measuring equipment
- Commercial & Industrial applications
- Automotive electronics applications
- Wireless communications
- PDA and Palm Pilots
- Credit Cards with Security Technology

STANDARD SPECIFICATIONS:

Absolute Maximum Ratings

Parameters	Min.	Typ.	Max.	Units	Notes
Supply Voltage (V _{DD})	-0.5		+6.5	V	
Battery Supply voltage (V _{BACKUP})	-0.5		+6.5	V	
Input Voltage (V _I)	-0.5		+6.5	V	
Output Voltage (V _O)	-0.5		+6.5	V	
Supply Current (I _{DD})	-50		+50	mA	
DC Input Current (I _I)	-10		+10	mA	
DC Output Current (I _O)	-10		+10	mA	
Operating Temperature Range (T _{OPR})	-40		+85	°C	
Storage Temperature (T _{STO})	-55		+125	°C	Stored as bare product

Frequency Characteristics

Parameters	Min.	Typ.	Max.	Units	Notes
Frequency Accuracy (ΔF/F)		±10	±20	ppm	T _{AMB} = +25°C; V _{DD} = 3.0V
Frequency vs Voltage (ΔF/V)		±0.8	±1.5	ppm/V	T _{AMB} = +25°C; V _{DD} = 1.8~5.5V
Frequency vs Temperature ΔF/T _{OPR})	-0.035ppm/°C ² (T _{OPR} - T _O) ² ±10%			ppm	T _{REF} = +25°C; V _{DD} = 3.0V
Turnover Temperature (T _O)	+20	+25	+30	°C	
Aging (first year)	-3		+3	ppm	T _{AMB} = +25°C
Oscillator Start-up Time (T _{START})		350	500	ms	T _{AMB} = +25°C
CLKOUT duty cycle	40	50	60	%	T _{AMB} = +25°C

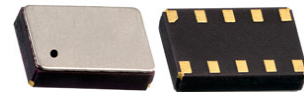

3.7 x 2.5 x 0.9 mm

AB-RTCMC-32.768kHz-B5ZE-S3



RoHS/RoHS II compliant

Static Characteristics

$V_{DD} = 1.2V$ to $5.5V$; $V_{SS} = 0V$; $T_{AMB} = -40^{\circ}C$ to $+85^{\circ}C$; $f_{OSC} = 32.768$ kHz; unless otherwise specified

Parameters		Min.	Typ.	Max.	Units	Notes
Supply Voltage (V_{DD})	For clock data integrity I ² C bus inactive	1.2		5.5	V	
	I ² C bus active	1.6		5.5		
	Power management function active	1.8		5.5		
Slew Rate (SR)	Of V_{DD}			± 0.5	V/ms	
Battery Supply Voltage (V_{BACKUP})	Power management function active	1.8		5.5	V	
Current Consumption (I_{DD}) I ² C bus active	$f_{SCL} = 1000$ kHz $V_{DD} = 3.0V$		100	200	μA	
	$f_{SCL} = 100$ kHz $V_{DD} = 3.0V$		50	100	μA	
Current Consumption (I_{DD0}) 1)	$V_{DD} = 3.0V$		130	180	nA	I ² C bus inactive ($f_{SCL} = 0$ Hz) Interrupts disabled CLKOUT disabled Power management fct. disabled (PM[2:0] = 111) $T_{amb} = +25^{\circ}C$
	$V_{DD} = 2.0V$		110	160	nA	
Current Consumption (I_{DD0}) 1)	$V_{DD} = 2.0$ to $5.0V$			500	nA	I ² C bus inactive ($f_{SCL} = 0$ Hz) Interrupts disabled CLKOUT disabled Power management fct. disabled (PM[2:0] = 111) $T_{amb} = -40 \sim +85^{\circ}C$
Current Consumption (I_{DD32k}) 2)	V_{BACKUP} or $V_{DD} = 3.0V$		1200		nA	I ² C bus inactive ($f_{SCL} = 0$ Hz) Interrupts disabled CLKOUT enabled (32.768kHz) Power management fct. enabled (PM[2:0] = 00 0) $T_{amb} = +25^{\circ}C$
Current Consumption (I_{DD32k}) 2)	V_{BACKUP} or $V_{DD} = 2.0$ to $5.0V$			3600	nA	I ² C bus inactive ($f_{SCL} = 0$ Hz) Interrupts disabled CLKOUT enabled (32.768kHz) Power management fct. enabled (PM[2:0] = 000) $T_{amb} = -40 \sim +85^{\circ}C$
Battery Leakage Current ($I_{L(bat)}$)	V_{DD} active; $V_{BACKUP} = 3.0V$		50	100	nA	

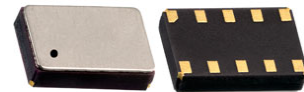

(Continued)

$V_{DD} = 1.2\text{ V to } 5.5\text{ V}; V_{SS} = 0\text{ V}; T_{AMB} = -40^{\circ}\text{C to } +85^{\circ}\text{C}; f_{OSC} = 32.768\text{ kHz};$ unless otherwise specified

Parameters	Min.	Typ.	Max.	Units	Notes	
Power Management						
Battery Switch Threshold Voltage ($V_{th(sw)bat}$)	2.28	2.5	2.7	V		
Inputs ³⁾						
LOW Level Input Voltage (V_{IL})			$30\%V_{DD}$	V		
HIGH Level Input Voltage (V_{IH})	$70\%V_{DD}$			V		
Input Voltage (V_I)	-0.5		$V_{DD}+0.5$	V		
Input Leakage Current(I_L)	$V_I = V_{DD}$ or V_{SS}		0	nA		
	Post ESD Event	-1		+1	μA	
Input Capacitance(C_I) ⁴⁾			7	pF		
Outputs						
Output Voltage (V_O)	On pin $\overline{\text{INT}}_1$, $\overline{\text{INT}}_2$, CLKOUT, SDA (refers to ext. pull-up voltage)		-0.5		+5.5	V
LOW Level Output Voltage (V_{OL})			V_{SS}		0.4	V
LOW Level Output Current (I_{OL}) ⁵⁾	Output sink current; On pin $\overline{\text{INT}}_1$, $\overline{\text{INT}}_2$, CLKOUT $V_{OL}=0.4\text{V}; V_{DD}=5.0\text{V}$		1.5			mA
	On pin SDA $V_{OL}=0.4\text{V}; V_{DD}=3.0\text{V}$		20			
Output Leakage Current (I_{LO})	$V_O = V_{DD}$ or V_{SS}				0	nA
	Post ESD Event		-1		+1	μA

1) Timer source clock = 1/3600 Hz, level of pins SCL and SDA is V_{SS} or V_{DD} .

2) When the device is supplied via the V_{BACKUP} pin instead of the V_{DD} pin, the current values for I_{BACKUP} will be as specified for I_{DD} under the same conditions.

3) The I²C bus is 5V tolerant.

4) Implicit by design.

5) Tested on sample basis.

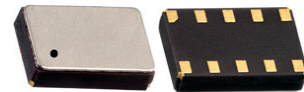

I²C Interface Dynamic Characteristics

Parameters	Symbol	Standard Mode		Fast Mode (FM)		Fast Mode Plus (FM+) ¹⁾		Units
		Min.	Max.	Min.	Max.	Min.	Max.	
Pin SCL								
SCL clock frequency ²⁾	f _{SCL}		100		400		1000	kHz
LOW period of SCL clock	t _{LOW}	4.7		1.3		0.5		μs
HIGH period of SCL clock	t _{HIGH}	4.0		1.6		0.26		μs
Pin SDA								
Data setup time	t _{SU;DAT}	250		100		50		ns
Data hold time	t _{HD;DAT}	0		0		0		ns
Pin SCL and SDA								
Bus free time between STOP and START condition	t _{BUF}	4.7		1.3		0.5		μs
Setup time for STOP condition	t _{SU;STO}	4.0		0.6		0.26		μs
Hold time (repeated) START condition	t _{HD;STA}	4.0		0.6		0.26		μs
Setup time for repeated START condition	t _{SU;STA}	4.7		0.6		0.26		μs
Rise time of both SDA and SCL signals ^{3) 4)}	t _r		1000	20+0.1C _b	300		120	ns
Fall time of both SDA and SCL signals ^{3) 4)}	t _f		300	20+0.1C _b	300		120	ns
Capacitive load for each bus line	C _b		400		400		550	pF
Data valid acknowledge time ⁵⁾	t _{VD;ACK}		3.45		0.9		0.45	μs
Data valid time ⁶⁾	t _{VD;DAT}		3.45		0.9		0.45	μs
Pulse width of spikes that must be suppressed by the input filter ⁷⁾	t _{SP}		50		50		50	ns

1) Fast mode plus guaranteed at 3.0 V < V_{DD} < 5.5 V.

2) The minimum SCL clock frequency is limited by the bus timeout feature, which resets the serial bus interface if either the SDA or SCL is held LOW for a minimum of 25 ms. The bus timeout feature must be disabled for DC operation.

3) A master device must internally provide a hold time of at least 300 ns for the SDA signal (refer to the V_{IL} of the SCL signal) in order to bridge the undefined region of the falling edge of SCL.

4) The maximum t_r for the SDA and SCL bus lines is 300 ns. The maximum fall time for the SDA output stage, t_f is 250 ns. This allows series protection resistors to be connected between the SDA pin, the SCL pin and the SDA/SCL bus lines without exceeding the maximum t

5) t_{VD;ACK} = time for acknowledgement signal from SCL LOW to SDA output LOW.

6) t_{VD;DAT} = minimum time for valid SDA output following SCL LOW.

7) Input filters on the SDA and SCL inputs suppress noise spikes of less than 50 ns.

I²C Interface Timing Characteristics

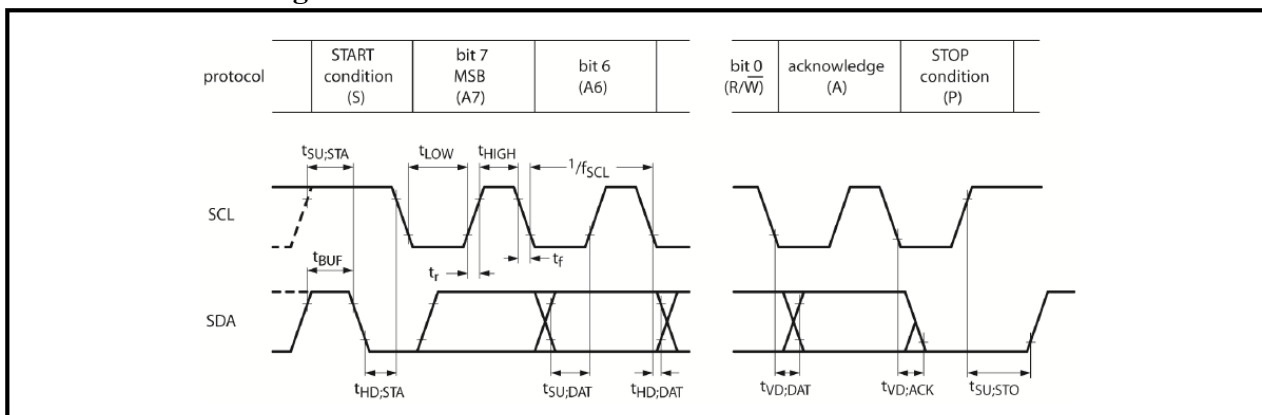

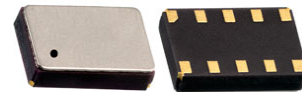

3.7 x 2.5 x 0.9 mm

AB-RTCMC-32.768kHz-B5ZE-S3



RoHS/RoHS II compliant

PART IDENTIFICATIONS:

AB -RTCMC -32.768 kHz-B5ZE -S3-



Packaging

Blank: Bulk

T: 1000pcs/reel

OUTLINE DIMENSIONS:

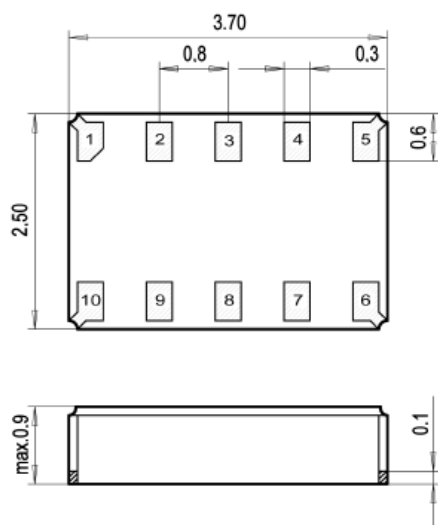

Recommended Land Pattern

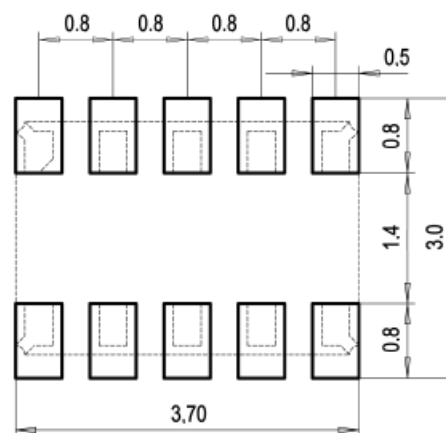

Dimensions: mm

PIN DESCRIPTIONS:

Pin No.	Pin Name	Function
1	V _{DD}	Power Supply Voltage
2	INT_1	Interrupt_1 Output pin
3	SCL	Serial Clock Input pin
4	SDA	Serial Data Input-Output pin
5	CLKOUT	Clock Output pin; open-drain; requires pull-up resistor
6	INT_2	Interrupt_2 Output pin
7	V _{SS}	Ground
8	V _{BACKUP}	Backup Supply Voltage
9	N.C.	Not Connected
10	N.C.	Not Connected

Real Time Clock Module with I²C Bus

AB-RTCMC-32.768kHz-B5ZE-S3



RoHS/RoHS II compliant

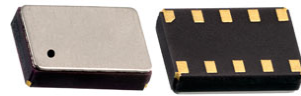

3.7 x 2.5 x 0.9 mm

BLOCK DIAGRAM:

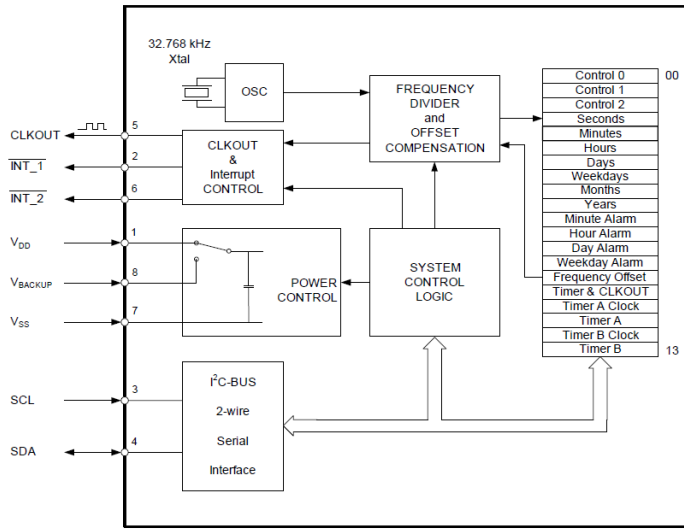

RECOMMENDED REFLOW PROFILE:

Maximum Reflow Conditions in accordance with IPC/JEDEC J-STD-020C “Pb-free”

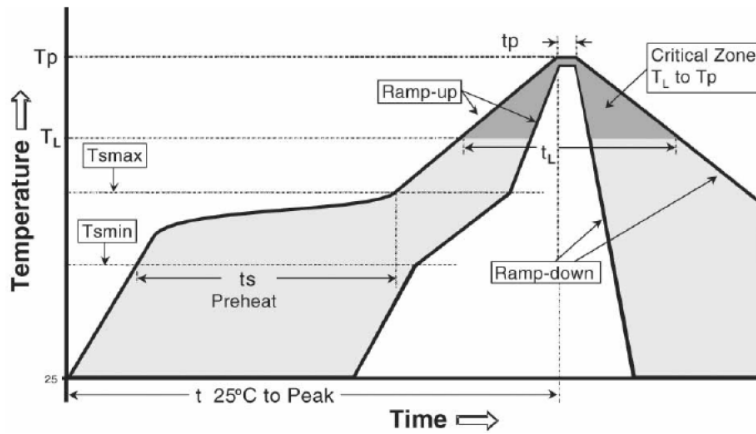

Temperature	Conditions	Units
Average Ramp-up Rate (T _{Smax} to T _p)	3°C/second max	°C/s
Ramp Down Rate (T _{cool})	6°C/second max	°C/s
Time 25°C to Peak Temperature (T _{to-peak})	8 minutes max	m
Preheat		
Temperature Min (T _{Smin})	150	°C
Temperature Max (T _{Smax})	200	°C
Time T _{Smin} to T _{Smax} (t _s)	60 ~ 180	sec
Time Above Liquidus		
Temperature Liquidus (T _L)	217	°C
Time above Liquidus (t _L)	60 ~ 150	sec
Peak Temperature		
Peak Temperature (T _p)	260	°C
Time within 5°C of Peak Temperature (t _p)	20 ~ 40	sec

Real Time Clock Module with I²C Bus

AB-RTCMC-32.768kHz-B5ZE-S3



RoHS/RoHS II compliant

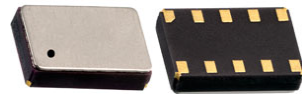

3.7 x 2.5 x 0.9 mm

TAPE & REEL:

T = 1000pcs/reel

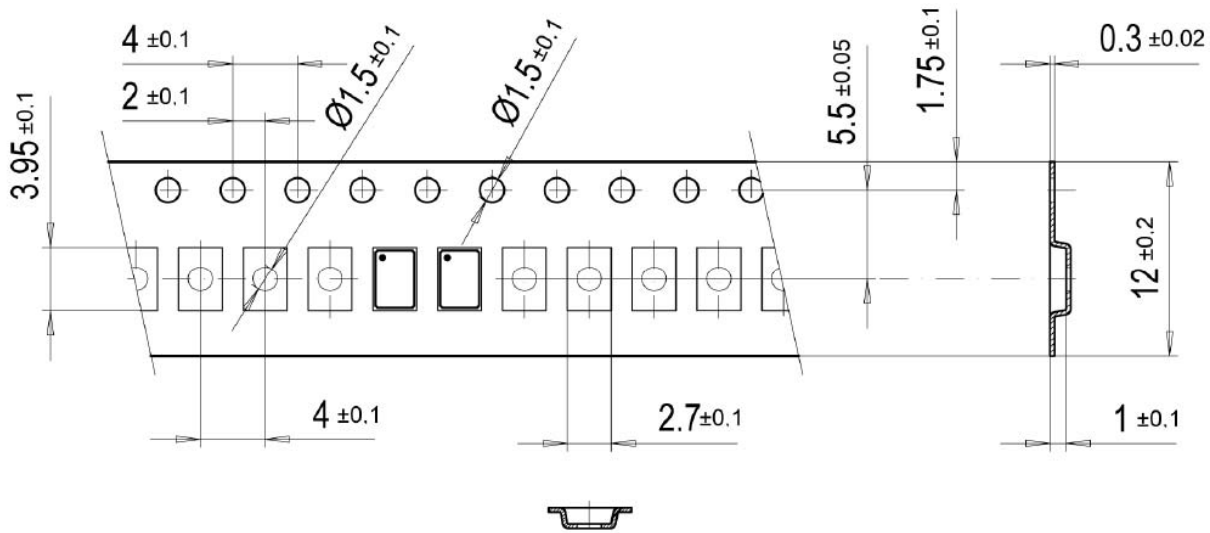

 User Direction of Feed

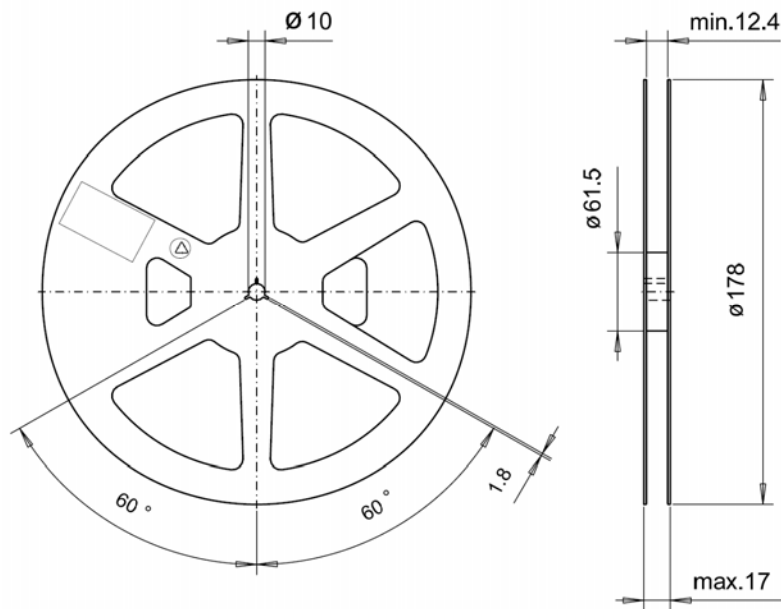

Dimension: mm

ATTENTION: Abracon LLC's products are COTS – Commercial-Off-The-Shelf products; suitable for Commercial, Industrial and, where designated, Automotive Applications. Abracon's products are not specifically designed for Military, Aviation, Aerospace, Life-dependant Medical applications or any application requiring high reliability where component failure could result in loss of life and/or property. For applications requiring high reliability and/or presenting an extreme operating environment, written consent and authorization from Abracon LLC is required. Please contact Abracon LLC for more information.



5101 Hidden Creek Ln Spicewood TX 78669
 Phone: 512-371-6159 | Fax: 512-351-8858
 For terms and conditions of sales, please visit:
www.abracon.com

REVISED: 11.28.2018

ABRACON IS
 ISO9001-2015
 CERTIFIED

X-ON Electronics

Largest Supplier of Electrical and Electronic Components

Click to view similar products for [Real Time Clock](#) category:

Click to view products by [ABRACON](#) manufacturer:

Other Similar products are found below :

[DS1302Z-LF](#) [710029X](#) [879047C](#) [405800G](#) [PT7C43390LE](#) [RV-3029-C2-32.768k-OPTION-B-TB-QA](#) [RV-2123-C2-32.768k-20PPM-TA-QA](#) [RV-3029-C2-32.768k-OPTION-A-TB-QA](#) [RV-1805-C3-32.768k-2PPM-TA-QA](#) [RV-3029-C3-32.768k-OPTION-A-TB-QA](#) [RV-2123-C2-32.768kHz-20PPM-TA-QC](#) [RX-4035LC:B3 PURE SN](#) [RX-8564LC:B PURE SN](#) [RX-8803LCUB PURE SN BULK](#) [RX-8571LCB0 PURE SN](#) [BQ32002D](#) [RTC-8564JE](#) [MCP7940M-I/P](#) [DS3231SN#T&R](#) [DS1391U-18+](#) [DS1347T+T&R](#) [RX-8564LC:B3 PURE SN](#) [DS1338Z-33+T](#) [RX-4571SA:B3 PURE SN](#) [DS1340U-33+T&R](#) [RX-8571LC:B3 PURE SN](#) [PCF8583T/5.518](#) [S-35190A-J8T1U](#) [RTC-4543SAB](#) [RTC-72421A](#) [RTC-72423A](#) [RX-8803LC:UB3 PURE SN](#) [RX-8803SA:UB3 PURE SN](#) [S-35390A-T8T1](#) [AB1815-T3](#) [AB-RTCMC-32.768kHz-AIGZ-S7-T](#) [AB-RTCMC-32.768kHz-B5GA-S3-T](#) [AB-RTCMC-32.768kHz-B5ZE-S3-T](#) [AB-RTCMC-32.768kHz-EOA9-S3-D-B-T](#) [AB-RTCMC-32.768kHz-EOZ9-S3-D-B-T](#) [AB-RTCMC-32.768KHZ-EOZ9-S3-HAT](#) [AB-RTCMC-32.768KHZ-IBO5-S3-T](#) [AB-RTCMC-32.768kHz-ZIZE-S2-T](#) [DS1672U-33+](#) [DS1372U+](#) [DS1337U+T&R](#) [DS1340U-18+](#) [DS1339BU+](#) [DS1339AU+](#) [DS1339U-2+](#)