

# Ultra-low Power Real Time Clock Module with I<sup>2</sup>C Bus

AB-RTCMC-32.768kHz-IBO5-S3



ESD Sensitive



RoHS/RoHS II compliant

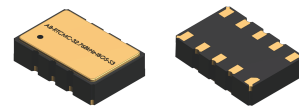

3.7 x 2.5 x 0.9 mm

Moisture Sensitivity Level: MSL=1

## FEATURES:

- Ultra-Low current consumption:  
XTAL Mode 60nA typ. @3.0V  
RC Mode 17nA typ. @3.0V  
RC Autocalibrated Mode 22nA typ. @3.0V
- RTC module with built-in crystal oscillating at 32.768 kHz
- Operating voltage: 1.5 – 3.6V
- Operating temperature range: -40 to +85°C
- Factory calibrated Time accuracy ±2.0ppm typ. @ 25°C
- Automatic Battery Switchover
- Trickle Charger, Power Management & Power Switch Function
- Programmable CLKOUT frequencies
- I<sup>2</sup>C Bus Interface (fast mode 400kHz)
- Time keeping mode down to 1.5 V
- Programmable Alarm, Timer and INT
- Up to 512 Bytes of general purpose RAM
- Small and compact package size: 3.7 x 2.5 x 0.9 mm. RoHS-compliant and 100% lead free

## APPLICATIONS:

- Smart cards
- Wireless sensors and tags
- Medical/Healthcare electronics
- Sports and fitness electronics
- Smart Utility meters
- Data loggers
- Appliances
- Tracking systems
- Home security systems
- Industrial and Consumer electronics
- Communications equipment

## STANDARD SPECIFICATIONS:

### Absolute Maximum Ratings

Parameters		Min.	Typ.	Max.	Units	Notes
Power Supply Voltage (V <sub>DD</sub> )		-0.3		3.8	V	
Backup Supply voltage (V <sub>BACKUP</sub> )		-0.3		3.8	V	
Input Voltage (V <sub>I</sub> )	V <sub>DD</sub> Power state	-0.3		V <sub>DD</sub> + 0.3	V	
	V <sub>BACKUP</sub> Power State	-0.3		V <sub>BACUUP</sub> + 0.3	V	
Output Voltage (V <sub>O</sub> )	V <sub>DD</sub> Power state	-0.3		V <sub>DD</sub> + 0.3	V	
	V <sub>BACKUP</sub> Power State	-0.3		V <sub>BACUUP</sub> + 0.3	V	
Input Current (I <sub>I</sub> )		-10		10	mA	
Output Current (I <sub>O</sub> )		-20		20	mA	
PSW Output Continuous Current (I <sub>OPC</sub> )				50	mA	
PSW Output Pulsed Current (I <sub>OPP</sub> )				150	mA	1 second pulse
ESD Voltage (V <sub>ESD</sub> )	CDM			±500	V	Charged Device Model
	HBM			±4000	V	Human Body Model
Latch-up Current (I <sub>LU</sub> )				100	mA	
Operating Temperature Range (T <sub>OP</sub> )		-40		+85	°C	
Storage Temperature (T <sub>STG</sub> )		-55		+125	°C	Stored as bare product
Lead Temperature (T <sub>SLD</sub> )				+300	°C	Hand soldering for 10s
Reflow Soldering Temperature (T <sub>REF</sub> )				+260	°C	Reflow profile per JEDEC J-STD-020D

# Ultra-low Power Real Time Clock Module with I<sup>2</sup>C Bus

AB-RTCMC-32.768kHz-IBO5-S3



RoHS/RoHS II compliant

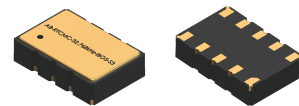

3.7 x 2.5 x 0.9 mm

## Power Supply and Switchover Parameters

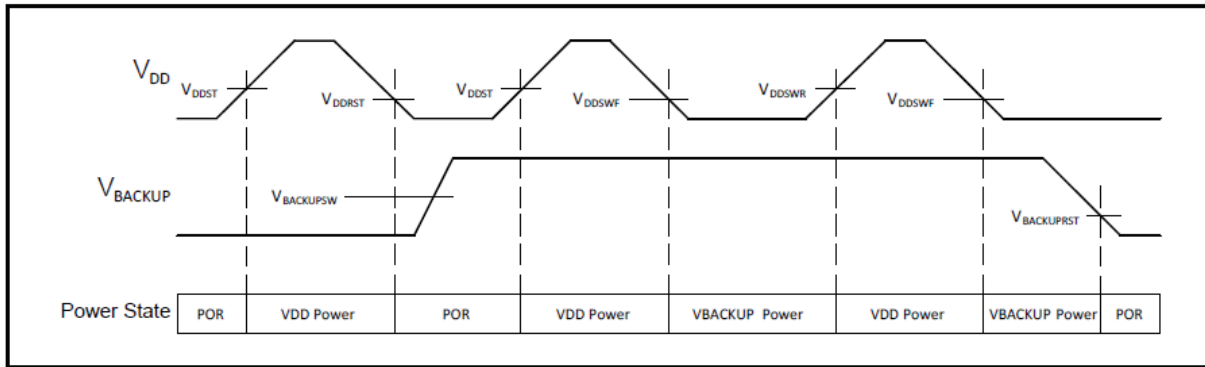

$T_A = -40$  to  $+85^\circ\text{C}$ , Typ. values at  $+25^\circ\text{C}$

Parameters	Type	Power State	Test Conditions	Min.	Typ.	Max.	Units
System Power Voltage ( $V_{DD}$ )	Static	$V_{DD}$ Power	Clocks operating and RAM and registers retained	1.5		3.6	V
$V_{DD}$ I <sup>2</sup> C Interface Voltage ( $V_{DDIO}$ )	Static	$V_{DD}$ Power	I <sup>2</sup> C operation	1.5		3.6	V
$V_{DD}$ Start-up Voltage ( $V_{DDST}$ ) <sup>(1)</sup>	Rising	POR $\rightarrow$ $V_{DD}$ Power		1.6			V
$V_{DD}$ Reset Voltage ( $V_{DDRST}$ )	Falling	$V_{DD}$ Power $\rightarrow$ POR	$V_{BACKUP} < V_{BACKUP, MIN}$ or no $V_{BACKUP}$		1.3	1.5	V
$V_{DD}$ Rising Switchover Threshold Voltage ( $V_{DDSWR}$ )	Rising	$V_{BACKUP}$ Power $\rightarrow$ $V_{DD}$ Power	$V_{BACKUP} \geq V_{BACKRST}$		1.6	1.7	V
$V_{DD}$ Falling Switchover Threshold Voltage ( $V_{DDSWF}$ )	Falling	$V_{DD}$ Power $\rightarrow$ $V_{BACKUP}$ Power	$V_{BACKUP} \geq V_{BACKSW, MIN}$	1.2	1.5		V
$V_{DD}$ Switchover Threshold Hysteresis ( $V_{DDSWH}$ ) <sup>(2)</sup>	Hyst.	$V_{DD}$ Power $\leftrightarrow$ $V_{BACKUP}$ Power			70		mV
$V_{DD}$ Falling Slew Rate to Switch to $V_{BACKUP}$ State ( $V_{DDFS}$ ) <sup>(4)</sup>	Falling	$V_{DD}$ Power $\rightarrow$ $V_{BACKUP}$ Power	$V_{DD} < V_{DDSW, MAX}$	0.7	1.4		V
Backup Voltage ( $V_{BACKUP}$ )	Static	$V_{BACKUP}$ Power	Clocks operating and RAM and registers retained	1.4		3.6	V
Backup Switchover Voltage Range ( $V_{BACKSW}$ ) <sup>(5)</sup>	Static	$V_{DD}$ Power $\rightarrow$ $V_{BACKUP}$ Power		1.6		3.6	V
Falling Backup POR Voltage ( $V_{BACKRST}$ ) <sup>(7)</sup>	Falling	$V_{BACKUP}$ Power $\rightarrow$ POR	$V_{DD} < V_{DDSWF}$		1.1	1.4	V
$V_{BACK}$ Margin above $V_{DD}$ ( $V_{BMRG}$ ) <sup>(3)</sup>	Static	$V_{BACKUP}$ Power		200			mV
$V_{BACK}$ Supply Series Resistance ( $R_{BACKESR}$ ) <sup>(6)</sup>	Static	$V_{BACKUP}$ Power		1.0	1.5		k $\Omega$

# Ultra-low Power Real Time Clock Module with I<sup>2</sup>C Bus

AB-RTCMC-32.768kHz-IBO5-S3



RoHS/RoHS II compliant

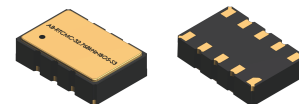

3.7 x 2.5 x 0.9 mm

- (1)  $V_{DD}$  must be above  $V_{DDST}$  to exit the POR state, independent of the  $V_{BACKUP}$  voltage.
- (2) Difference between  $V_{DDSWR}$  and  $V_{DDSWF}$ .
- (3)  $V_{BACKUP}$  must be higher than  $V_{DD}$  by at least this voltage to insure the AB-RTCMC-32.768kHz-IBO5-S3 remains in the  $V_{BACKUP}$  Power state.
- (4) Maximum  $V_{DD}$  falling slew rate to guarantee correct switchover to  $V_{BACKUP}$  Power state. There is no  $V_{DD}$  falling slew rate requirement if switching to the  $V_{BACKUP}$  power source is not required.
- (5)  $V_{BACKUP}$  voltage to guarantee correct transition to  $V_{BACKUP}$  Power state when  $V_{DD}$  falls.
- (6) Total series resistance of the power source attached to the  $V_{BACKUP}$  pin. The optimal value is 1.5 k $\Omega$ , which may require an external resistor.  $V_{BACKUP}$  power source ESR (Equivalent Series Resistance) + external resistor value = 1.5 k $\Omega$ .
- (7)  $V_{BACKRST}$  is also the static voltage required on  $V_{BACKUP}$  for register data retention.

## Operating Parameters

$T_A = -40$  to  $+85^\circ\text{C}$ , Typ. values at  $+25^\circ\text{C}$

Parameters	Test Conditions	$V_{DD}$	Min.	Typ.	Max.	Units
Positive-going Input Threshold Voltage ( $V_{T+}$ )		3.0V		1.5	2.0	V
		1.8V		1.1	1.25	
Negative-going Input Threshold Voltage ( $V_{T-}$ )		3.0V	0.8	0.9		V
		1.8V	0.5	0.6		
Input Leakage Current ( $I_{LEAK}$ )		3.0V		0.02	80	nA
Input Capacitance ( $C_I$ )				3		pF
PSW Output Resistance to $V_{DD}$ ( $R_{DSON}$ )	PSW enabled	1.7V		1.7	5.8	$\Omega$
		1.8V		1.6	5.4	
		3.0V		1.1	3.8	
		3.6V		1.05	3.7	
Output Leakage Current ( $I_{OLEAK}$ )		1.7V – 3.6V		0.02	80	nA

## Oscillator Parameters

$T_A = -40$  to  $+85^\circ\text{C}$  unless otherwise indicated.  $V_{DD} = 1.7$  to  $3.6\text{V}$ , Typ. values at  $+25^\circ\text{C}$  and  $3.0\text{V}$

Parameters	Test Conditions	Min.	Typ.	Max.	Units
Crystal Frequency ( $F_{XT}$ )			32.768		kHz
XT Oscillator Failure Detection Frequency ( $F_{OF}$ )			8		kHz
Calibrated RC Oscillator Frequency ( $F_{RCC}$ ) <sup>(1)</sup>	Factory calibrated at $+25^\circ\text{C}$ , $V_{DD} = 2.8\text{V}$		64		Hz
Uncalibrated RC Oscillator Frequency ( $F_{RCU}$ )	Calibration disabled (OFFSETR=0) – 128Hz level	89	122	200	Hz
Uncalibrated RC Oscillator Cycle-to-Cycle Jitter,  Median  ( $J_{RCCC}$ )	Calibration disabled (OFFSETR=0) – 128Hz level		2000		ppm
	Calibration disabled (OFFSETR=0) – 1Hz level		500		
RC Oscillator Cycle-to-Cycle Jitter, MIN, MAX ( $J_{RCCC}$ )	128Hz level at $+25^\circ\text{C}$	-1		1	%
	128Hz level $-10$ to $+70^\circ\text{C}$	-3.5		3.5	
	128Hz level $-40$ to $+85^\circ\text{C}$	-10		10	
XT Mode Digital Calibration Accuracy ( $A_{XT}$ ) <sup>(1)</sup>	Calibrated at an initial temperature and voltage. Factory calibrated at $+25^\circ\text{C}$ , $V_{DD} = 3.0\text{V}$	-2		+2	ppm

# Ultra-low Power Real Time Clock Module with I<sup>2</sup>C Bus

AB-RTCMC-32.768kHz-IBO5-S3



RoHS/RoHS II compliant

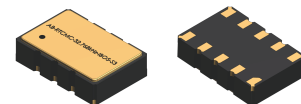

3.7 x 2.5 x 0.9 mm

(Continued)

$T_A = -40$  to  $+85^\circ\text{C}$  unless otherwise indicated.  $V_{DD} = 1.7$  to  $3.6\text{V}$ , Typ. values at  $+25^\circ\text{C}$  and  $3.0\text{V}$

Parameters	Test Conditions	Min.	Typ.	Max.	Units
Autocalibration Mode Timing Accuracy, 512 second period, $T_A = -10$ to $+60^\circ\text{C}$ ( $A_{AC}$ ) <sup>(1)</sup>	24 hour run time		35		ppm
	1 week run time		20		
	1 month run time		10		
	1 year run time		3		
Autocalibration Mode Operating Temperature ( $T_{AC}$ ) <sup>(2)</sup>		-10		+60	$^\circ\text{C}$

(1) Timing accuracy is specified at  $25^\circ\text{C}$  after digital calibration of the internal RC oscillator and digital calibration of the 32.768 kHz crystal. The 32.768 kHz tuning fork crystal has a negative temperature coefficient with a parabolic frequency deviation, which can result in a change of up to 150 ppm across the entire operating temperature range of  $-40^\circ\text{C}$  to  $85^\circ\text{C}$  in XT mode. Autocalibration mode timing accuracy is specified relative to XT mode timing accuracy from  $-10^\circ\text{C}$  to  $60^\circ\text{C}$ .

(2) Outside of this temperature range, the RC oscillator frequency change due to temperature may be outside of the allowable RC digital calibration range ( $\pm 12\%$ ) for autocalibration mode. When this happens, an autocalibration failure will occur and the ACF interrupt flag is set. The AB-RTCMC-32.768kHz-IBO5-S3 should be switched to use the XT oscillator as its clock source when this occurs. Please see the AUTOCALIBRATION FAILURE section in the application manual for more details.

## XT Frequency Characteristics

$T_A = -40$  to  $+85^\circ\text{C}$  unless otherwise indicated.  $V_{DD} = 1.7$  to  $3.6\text{V}$ , Typ. values at  $+25^\circ\text{C}$  and  $3.0\text{V}$ ,  $f_{OSC} = 32.768\text{kHz}$

Parameters	Test Conditions	Min.	Typ.	Max.	Units
Frequency Accuracy ( $\Delta F/F$ )	$T_A = +25^\circ\text{C}$ ; Calibration disabled (OFFSETX=0)		$\pm 100$ <sup>(1)</sup>		ppm
Frequency vs. Temperature Characteristics ( $\Delta F/F_0$ )	$T_{OPR} = -40$ to $+85^\circ\text{C}$	$-0.035^{\text{ppm}/^\circ\text{C}^2} * (T_{OPR} - T_0)^2 \pm 10\%$			ppm
Turnover Temperature ( $T_0$ )		+20	+25	+30	$^\circ\text{C}$
Aging First Year	$T_A = +25^\circ\text{C}$			$\pm 3$	ppm
Oscillator Start-up Voltage	$T_A = -40$ to $+85^\circ\text{C}$	1.6			V
Oscillator Start-up Time	$V_{DD} = 1.7\text{V} - 3.6\text{V}$		1.0		s
CLKOUT Duty Cycle	$F_{CLKOUT} = 32.768\text{kHz}$ ; $T_A = +25^\circ\text{C}$	50	60	70	%

(1) The XT mode digital calibration accuracy is  $\pm 2$  ppm, see OSCILLATOR PARAMETERS.

# Ultra-low Power Real Time Clock Module with I<sup>2</sup>C Bus

AB-RTCMC-32.768kHz-IBO5-S3



RoHS/RoHS II compliant

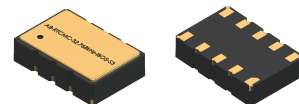

3.7 x 2.5 x 0.9 mm

XT Frequency vs. Temperature Characteristics

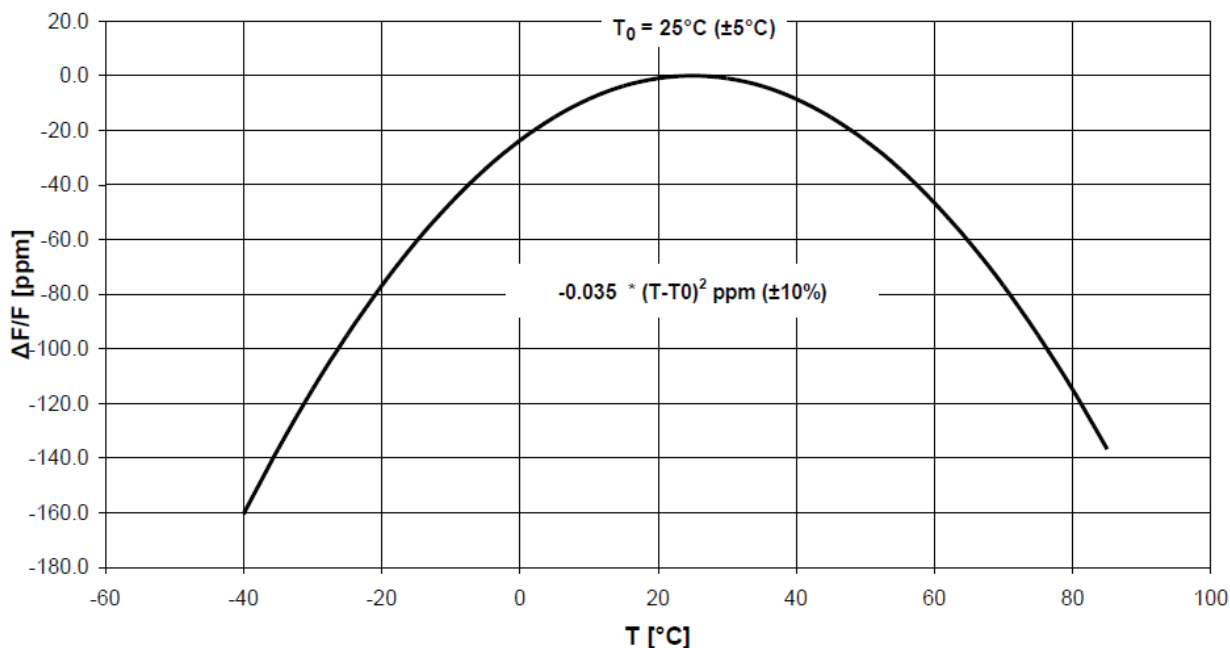

## V<sub>DD</sub> Supply Current

T<sub>A</sub> = -40 to +85°C. V<sub>BACKUP</sub> = 0 to 3.6V, Typ. values at +25°C, V<sub>DD</sub> power state

Parameters	Test Conditions	V <sub>DD</sub>	Min.	Typ.	Max.	Units
V <sub>DD</sub> Supply Current during I2C burst Read/Write (I <sub>VDD:I2C</sub> )	400kHz bus speed, 2.2k pull-up resistors on SCL/SDA <sup>(1)</sup>	3.0V		6	10	μA
		1.8V		1.5	3	
V <sub>DD</sub> Supply Current in XT Oscillator Mode (I <sub>VDD:XT</sub> )	Time keeping mode with XT oscillator running <sup>(2)</sup>	3.0V		60	330	nA
		1.8V		27	290	
V <sub>DD</sub> Supply Current in RC Oscillator Mode (I <sub>VDD:RC</sub> )	Time keeping mode with only the RC oscillator running (XT oscillator is off) <sup>(2)</sup>	3.0V		17	220	nA
		1.8V		14	170	
Average V <sub>DD</sub> Supply Current in Autocalibrated RC Oscillator Mode (I <sub>VDD:ACAL</sub> )	Time keeping mode with only the RC oscillator running and Autocalibration enabled. ACP=512 seconds <sup>(2)</sup>	3.0V		22	235	nA
		1.8V		18	190	
Additional V <sub>DD</sub> Supply Current with CLK/INT at 32.768kHz (I <sub>VDD:CK32</sub> )	Time keeping mode with XT oscillator running, 32.768kHz square wave on CLK/INT <sup>(3)</sup>	3.0V		0.71		μA
		1.8V		0.34		
Additional V <sub>DD</sub> Supply Current with CLK/INT at 64Hz (I <sub>VDD:CK64</sub> )	All time keeping mode, 64Hz square wave on CLK/INT <sup>(3)</sup>	3.0V		0.6		nA
		1.8V		0.3		

# Ultra-low Power Real Time Clock Module with I<sup>2</sup>C Bus

AB-RTCMC-32.768kHz-IBO5-S3



RoHS/RoHS II compliant

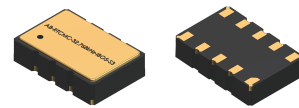

3.7 x 2.5 x 0.9 mm

- (1) Excluding external peripherals and pull-up resistor current. All other inputs (besides SDA and SCL) are at 0V or V<sub>DD</sub>.  
 Test conditions: Continuous burst read/write, 55h data pattern, 25 μs between each data byte, 20 pF load on each bus pin.
- (2) All inputs and outputs are at 0V or V<sub>DD</sub>.
- (3) All inputs and outputs except CLK / INT are at 0V or V<sub>DD</sub>. 15 pF load on CLK / INT, pull-up resistor current not included.

## V<sub>BACKUP</sub> Supply Current

T<sub>A</sub> = -40 to +85°C. Typ. values at +25°C, Max. values at +85°C. V<sub>BACKUP</sub> power state

Parameters	Test Conditions	V <sub>DD</sub>	V <sub>BACK</sub>	Min.	Typ.	Max.	Units
V <sub>BACKUP</sub> Supply Current in XT Oscillator Mode (I <sub>VBACK:XT</sub> )	Time keeping mode with XT oscillator running <sup>(1)</sup>	<V <sub>DDSWF</sub>	3.0V		63	330	nA
			1.8V		60	290	
V <sub>BACKUP</sub> Supply Current in RC Oscillator Mode (I <sub>VBACK:RC</sub> )	Time keeping mode with only the RC oscillator running (XT oscillator is off) <sup>(1)</sup>	<V <sub>DDSWF</sub>	3.0V		19	220	nA
			1.8V		16	170	
Average V <sub>BACKUP</sub> Supply Current in Autocalibrated RC Oscillator Mode (I <sub>VBACK:ACAL</sub> )	Time keeping mode with only the RC oscillator running and Autocalibration enabled. ACP=512 seconds <sup>(1)</sup>	<V <sub>DDSWF</sub>	3.0V		25	235	nA
			1.8V		21	190	
V <sub>BACKUP</sub> Supply Current in V <sub>DD</sub> powered mode (I <sub>VBACK:VDD</sub> )	V <sub>DD</sub> powered mode <sup>(1)</sup>	1.7-3.6V	3.0V	-5	0.6	20	nA
			1.8V	-10	0.5	16	

(1) Test conditions: All inputs and outputs are at 0V or V<sub>DD</sub>.

## BREF Electrical Characteristics

T<sub>A</sub> = -20 to +70°C. Typ. values at +25°C, V<sub>DD</sub> = 1.7 to 3.6V.

Parameters	BREF	Min.	Typ.	Max.	Units
V <sub>BACKUP</sub> Falling Threshold (V <sub>BRF</sub> )	0111	2.3	2.5	3.3	V
	1011	1.9	2.1	2.8	
	1101	1.6	1.8	2.5	
	1111		1.4		
V <sub>BACKUP</sub> Rising Threshold (V <sub>BRR</sub> )	0111	2.6	3.0	3.4	V
	1011	2.1	2.5	2.9	
	1101	1.9	2.2	2.7	
	1111		1.6		

# Ultra-low Power Real Time Clock Module with I<sup>2</sup>C Bus

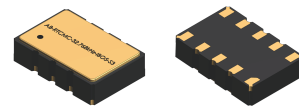

3.7 x 2.5 x 0.9 mm

AB-RTCMC-32.768kHz-IBO5-S3



RoHS/RoHS II compliant

(Continued)

T<sub>A</sub> = -20 to +70°C. Typ. values at +25°C, V<sub>DD</sub> = 1.7 to 3.6V.

Parameters	BREF	Min.	Typ.	Max.	Units
V <sub>BACKUP</sub> Threshold Hysteresis (V <sub>BRH</sub> )	0111		0.5		V
	1011		0.4		
	1101		0.4		
	1111		0.2		
BREF/BPOL Change to BBOD Valid (t <sub>BREF</sub> )	All valid BREF values		1000		ms
V <sub>BACKUP</sub> Analog Comparator Recommended Operating Temperature Range (T <sub>BR</sub> )	All valid BREF Values	-20		+70	°C

## I<sup>2</sup>C AC Electrical Characteristics

T<sub>A</sub> = -40 to +85°C. Typ. values at +25°C

Parameters	V <sub>DD</sub>	Min.	Typ.	Max.	Units
SCL Input Clock Frequency (f <sub>SCL</sub> )	1.7 – 3.6V	10		400	kHz
Low Period of SCL Clock (t <sub>LOW</sub> )	1.7 – 3.6V	1.3			µs
High Period of SCL Clock (t <sub>HIGH</sub> )	1.7 – 3.6V	600			ns
Rise Time of SDA and SCL (t <sub>RISE</sub> )	1.7 – 3.6V			300	ns
Fall Time of SDA and SCL (t <sub>FALL</sub> )	1.7 – 3.6V			300	ns
START Condition Hold Time (t <sub>HD:STA</sub> )	1.7 – 3.6V	600			ns
START Condition Setup Time (t <sub>SU:STA</sub> )	1.7 – 3.6V	600			ns
SDA Setup Time (t <sub>SU:DAT</sub> )	1.7 – 3.6V	100			ns
SDA Hold Time (t <sub>HD:DAT</sub> )	1.7 – 3.6V	0			ns
STOP Condition Setup Time (t <sub>SU:STO</sub> )	1.7 – 3.6V	600			ns
Bus Free Time before a New Transmission (t <sub>BUF</sub> )	1.7 – 3.6V	1.3			µs

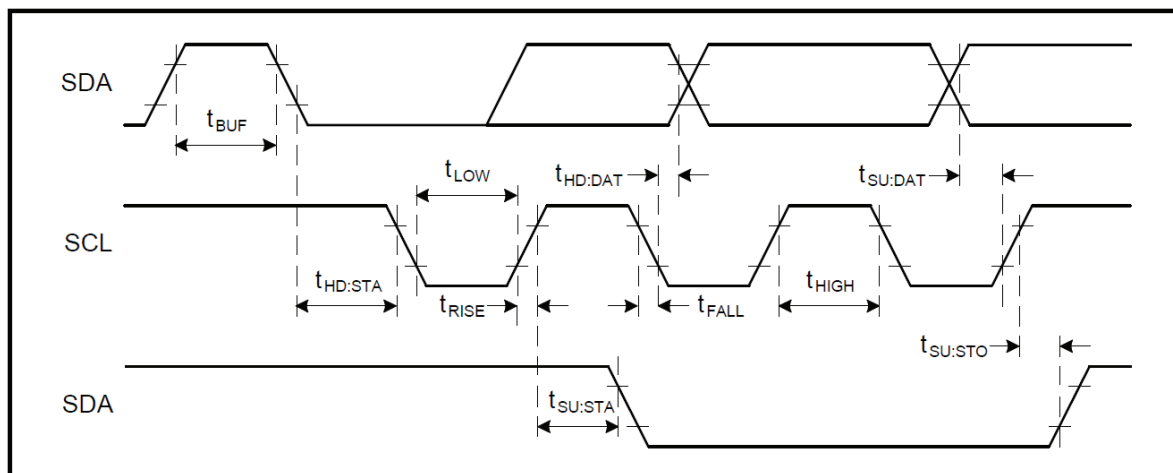

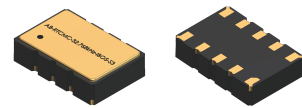

3.7 x 2.5 x 0.9 mm

AB-RTCMC-32.768kHz-IBO5-S3



RoHS/RoHS II compliant

## Power-on AC Electrical Characteristics

$T_A = -40$  to  $+85^\circ\text{C}$ .  $V_{\text{BACKUP}} < 1.2\text{V}$

Parameters	$V_{\text{DD}}$	$T_A$	Min.	Typ.	Max.	Units
Low Period of $V_{\text{DD}}$ to Ensure a Valid POR ( $t_{\text{LOW:VDD}}$ )	1.7 – 3.6V	+85°C		0.1		s
		+25°C		0.1		
		-20°C		1.5		
		-40°C		10		
$V_{\text{DD}}$ Low to $\overline{\text{CLK/INT}}$ Low ( $t_{\text{VL:CLK}}$ )	1.7 – 3.6V	+85°C		0.1		s
		+25°C		0.1		
		-20°C		1.5		
		-40°C		10		
$V_{\text{DD}}$ High to $\overline{\text{CLK/INT}}$ High ( $t_{\text{VH:CLK}}$ )	1.7 – 3.6V	+85°C		0.4		s
		+25°C		0.5		
		-20°C		3		
		-40°C		20		
$\overline{\text{CLK/INT}}$ High to XT Oscillator Start ( $t_{\text{XTST}}$ )	1.7 – 3.6V	+85°C		0.4		s
		+25°C		0.4		
		-20°C		0.5		
		-40°C		1.5		

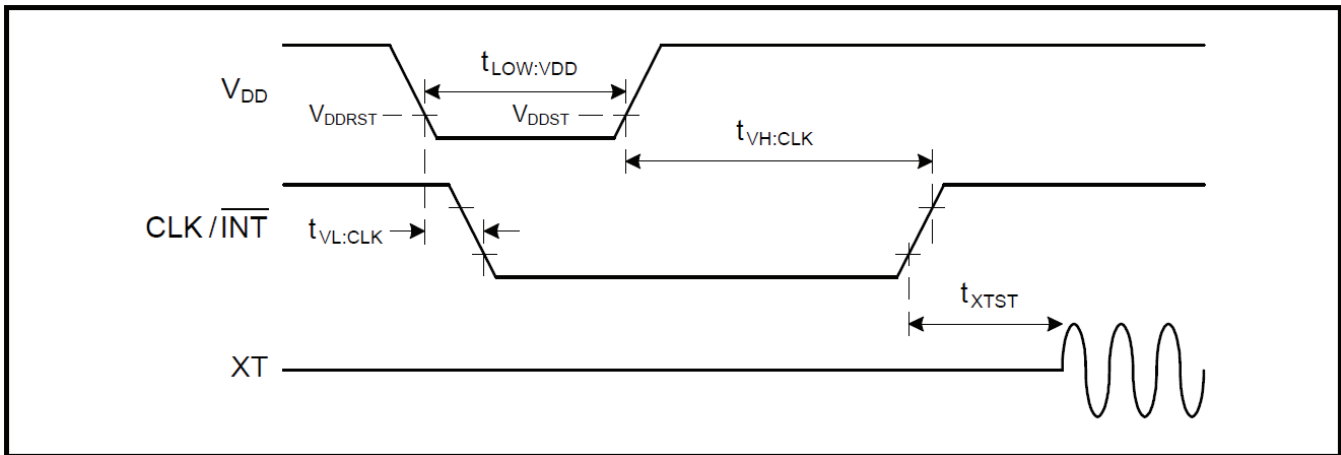



# Ultra-low Power Real Time Clock Module with I<sup>2</sup>C Bus

AB-RTCMC-32.768kHz-IBO5-S3



RoHS/RoHS II compliant

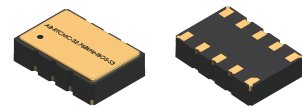

3.7 x 2.5 x 0.9 mm

## RST AC Electrical Characteristics

$T_A = -40$  to  $+85^\circ\text{C}$ .  $V_{\text{BACKUP}} < 1.2\text{V}$

Parameters	$V_{\text{DD}}$	$T_A$	Min.	Typ.	Max.	Units
Low Period of $V_{\text{DD}}$ to Ensure a Valid POR ( $t_{\text{LOW:VDD}}$ )	1.7 – 3.6V	+85°C		0.1		s
		+25°C		0.1		
		-20°C		1.5		
		-40°C		10		
$V_{\text{DD}}$ Low to $\overline{\text{RST}}$ Low ( $t_{\text{VL:NRST}}$ )	1.7 – 3.6V	+85°C		0.1		s
		+25°C		0.1		
		-20°C		1.5		
		-40°C		10		
$V_{\text{DD}}$ High to $\overline{\text{RST}}$ High ( $t_{\text{VH:NRST}}$ )	1.7 – 3.6V	+85°C		0.5		s
		+25°C		0.5		
		-20°C		3.5		
		-40°C		25		

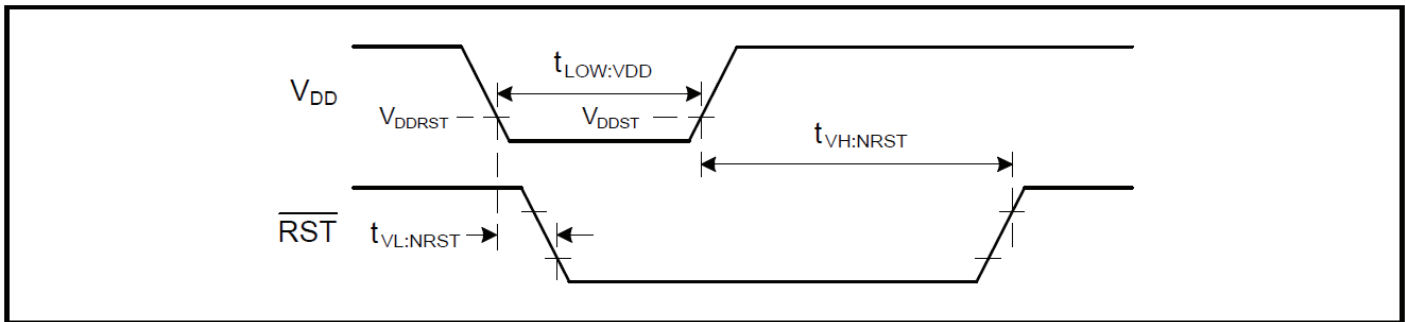

## PART IDENTIFICATION:

AB-RTCMC-32.768 kHz-IBO5-S3-



Packaging
Blank: Bulk
T: 1000pcs/reel

# Ultra-low Power Real Time Clock Module with I<sup>2</sup>C Bus

AB-RTCMC-32.768kHz-IBO5-S3



RoHS/RoHS II compliant

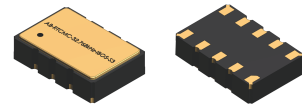

3.7 x 2.5 x 0.9 mm

## OUTLINE DIMENSION:

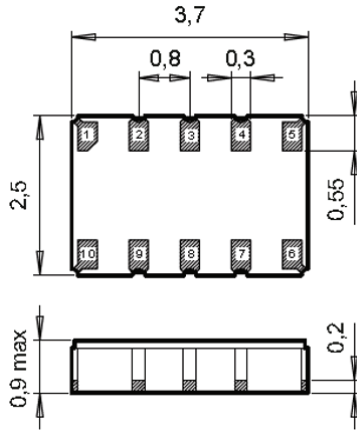

Recommended Land Pattern

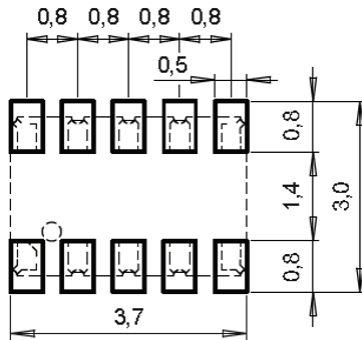

Pin No.	Pin Name	Function
1	V <sub>DD</sub>	Power Supply Voltage
2	Cap_RC	Capacitor RC-Oscillator
3	CLK/INT	Clock Output/Interrupt
4	SCL	Serial Clock Input
5	SDA	Serial Data
6	V <sub>SS</sub>	Ground
7	V <sub>BACKUP</sub>	Backup Supply Voltage
8	PSW	Power Switch Output
9	WDI	Watchdog Input
10	RST	Reset Output

Dimensions: mm

## BLOCK DIAGRAM:

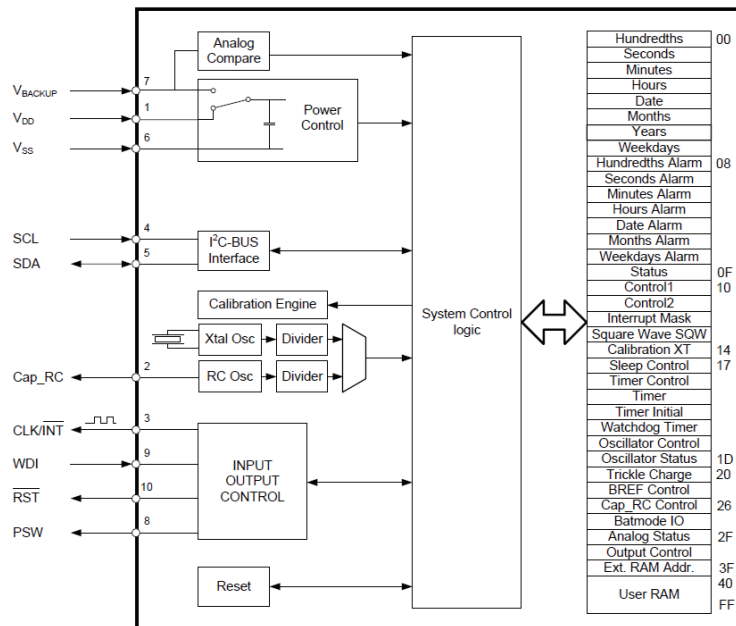

# Ultra-low Power Real Time Clock Module with I<sup>2</sup>C Bus

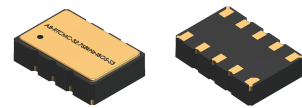

AB-RTCMC-32.768kHz-IBO5-S3



RoHS/RoHS II compliant

3.7 x 2.5 x 0.9 mm

## REFLOW PROFILE:

Maximum Reflow Conditions in accordance with IPC/JEDEC J-STD-020C "Pb-free"

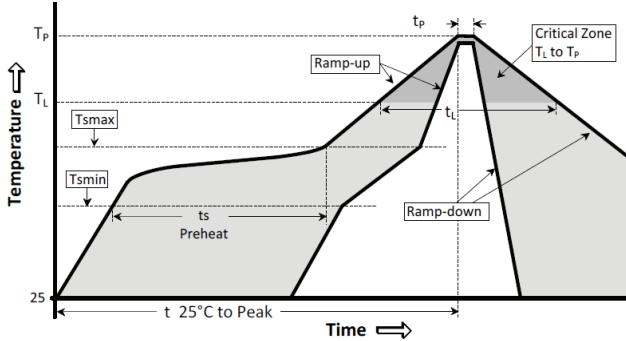

Temperature	Conditions	Units
Average Ramp-up Rate ( $T_{Smax}$ to $T_P$ )	3°C/second max	°C/s
Ramp Down Rate ( $T_{cool}$ )	6°C/second max	°C/s
Time 25°C to Peak Temperature ( $T_{to-peak}$ )	8 minutes max	m
<b>Preheat</b>		
Temperature Min ( $T_{Smin}$ )	150	°C
Temperature Max ( $T_{Smax}$ )	200	°C
Time $T_{Smin}$ to $T_{Smax}$ ( $t_s$ )	60 ~ 180	sec
<b>Time Above Liquidus</b>		
Temperature Liquidus ( $T_L$ )	217	°C
Time above Liquidus ( $t_l$ )	60 ~ 150	sec
<b>Peak Temperature</b>		
Peak Temperature ( $T_P$ )	260	°C
Time within 5°C of Peak Temperature ( $t_p$ )	20 ~ 40	sec

## TAPE & REEL:

T = 1000pcs/reel

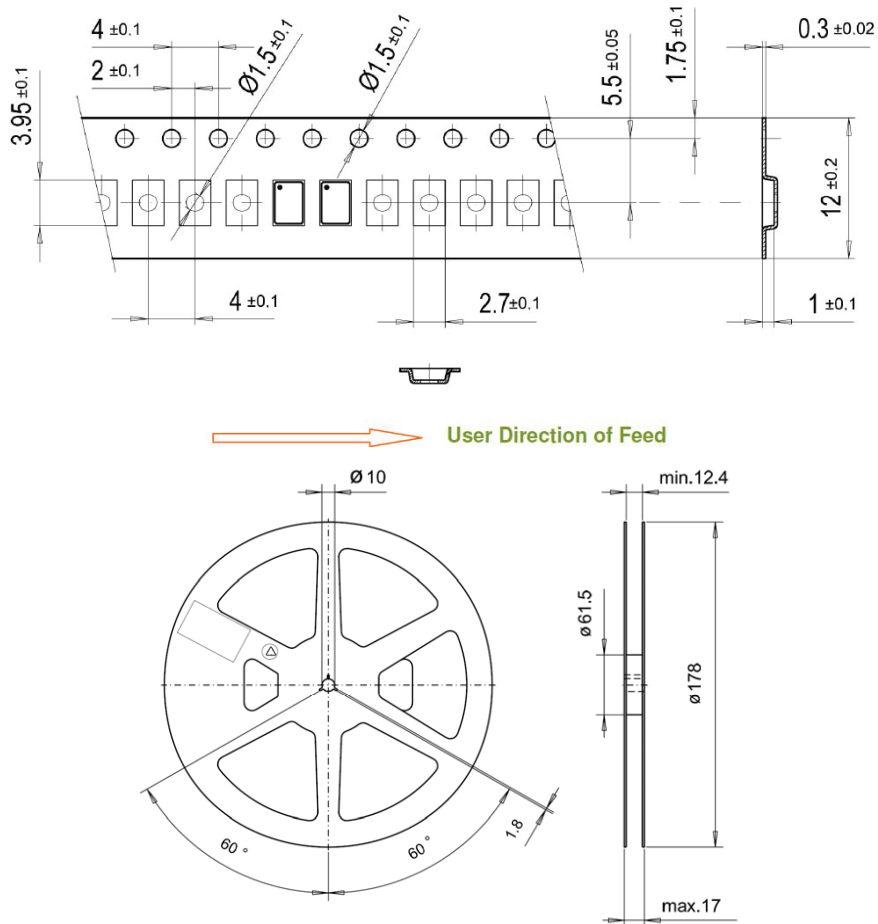

Dimensions: mm

**ATTENTION:** Abracon Corporation's products are COTS – Commercial-Off-The-Shelf products; suitable for Commercial, Industrial and, where designated, Automotive Applications. Abracon's products are not specifically designed for Military, Aviation, Aerospace, Life-dependant Medical applications or any application requiring high reliability where component failure could result in loss of life and/or property. For applications requiring high reliability and/or presenting an extreme operating environment, written consent and authorization from Abracon Corporation is required. Please contact Abracon Corporation for more information.



5101 Hidden Creek Ln Spicewood TX 78669  
 Phone: 512-371-6159 | Fax: 512-351-8858  
 For terms and conditions of sales, please visit:  
[www.abracon.com](http://www.abracon.com)

REVISED: 01.08.2019

ABRACON IS  
 ISO9001-2015  
 CERTIFIED

## X-ON Electronics

Largest Supplier of Electrical and Electronic Components

*Click to view similar products for [Real Time Clock](#) category:*

*Click to view products by [ABRACON](#) manufacturer:*

Other Similar products are found below :

[DS1302Z-LF](#) [710029X](#) [879047C](#) [405800G](#) [PT7C43390LE](#) [RV-3029-C2-32.768k-OPTION-B-TB-QA](#) [RV-2123-C2-32.768k-20PPM-TA-QA](#) [RV-3029-C2-32.768k-OPTION-A-TB-QA](#) [RV-1805-C3-32.768k-2PPM-TA-QA](#) [RV-3029-C3-32.768k-OPTION-A-TB-QA](#) [RV-2123-C2-32.768kHz-20PPM-TA-QC](#) [RX-4035LC:B3 PURE SN](#) [RX-8564LC:B PURE SN](#) [RX-8803LCUB PURE SN BULK](#) [RX-8571LCB0 PURE SN](#) [BQ32002D](#) [RTC-8564JE](#) [MCP7940M-I/P](#) [DS3231SN#T&R](#) [DS1391U-18+](#) [DS1347T+T&R](#) [RX-8564LC:B3 PURE SN](#) [DS1338Z-33+T](#) [RX-4571SA:B3 PURE SN](#) [DS1340U-33+T&R](#) [RX-8571LC:B3 PURE SN](#) [PCF8583T/5.518](#) [S-35190A-J8T1U](#) [RTC-4543SAB](#) [RTC-72421A](#) [RTC-72423A](#) [RX-8803LC:UB3 PURE SN](#) [RX-8803SA:UB3 PURE SN](#) [S-35390A-T8T1](#) [AB1815-T3](#) [AB-RTCMC-32.768kHz-AIGZ-S7-T](#) [AB-RTCMC-32.768kHz-B5GA-S3-T](#) [AB-RTCMC-32.768kHz-B5ZE-S3-T](#) [AB-RTCMC-32.768kHz-EOA9-S3-D-B-T](#) [AB-RTCMC-32.768kHz-EOZ9-S3-D-B-T](#) [AB-RTCMC-32.768KHZ-EOZ9-S3-HAT](#) [AB-RTCMC-32.768KHZ-IBO5-S3-T](#) [AB-RTCMC-32.768kHz-ZIZE-S2-T](#) [DS1672U-33+](#) [DS1372U+](#) [DS1337U+T&R](#) [DS1340U-18+](#) [DS1339BU+](#) [DS1339AU+](#) [DS1339U-2+](#)