

WiFi + GPS Multiband Ceramic Chip Antenna

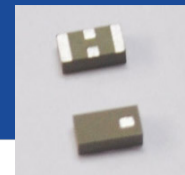

ACAG0301-15752450-T



3.2 x 1.6 x 1.2mm
RoHS/RoHS II Compliant
MSL = 1

FEATURES

- Made using LTCC (low temperature co-fired ceramic) technology
- Gain of 1.21dBi | 3.18dBi
- 1575MHz and 2450MHz frequency bands
- Small form factor 3.2 x 1.6 x 1.2mm
- Omni-directional

APPLICATIONS

- IoT and wearable
- GPS devices
- Wifi
- Bluetooth
- ISM applications

ELECTRICAL CHARACTERISTICS

Item	Specification	
Frequency	1575 MHz	2450 MHz
Bandwidth	20 MHz typ (1565~1585 MHz)	100 MHz (2400~2500 MHz)
Peak Gain	1.21 dBi	3.18 dBi
Return Loss	≥10 dB	
Impedance	50 Ω	
Operating Temperature Range	-40°C to + 85°C	

MECHANICAL DIMENSION (mm)

Antenna Dimension

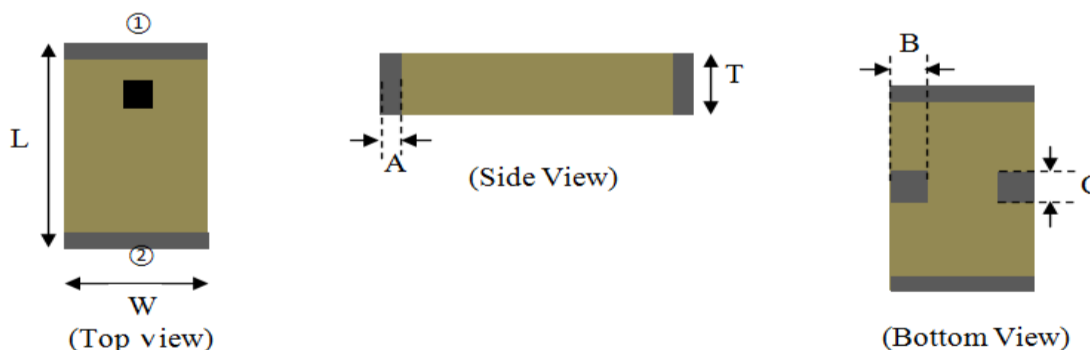

Number	Terminal Name	Number	Terminal Name
①	INPUT-GPS	③	GND
②	INPUT-2.4GHz	④	GND

Symbols	L	W	T	A	B	C
Dimensions	3.2+/-0.2	1.6+/-0.2	1.2+/-0.15	0.2+/-0.15	0.5+/-0.15	0.47+/-0.15

WiFi + GPS Multiband Ceramic Chip Antenna

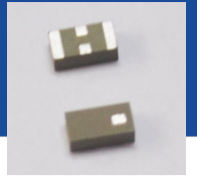

ACAG0301-15752450-T



3.2 x 1.6 x 1.2mm
RoHS/RoHS II Compliant

MSL = 1

MECHANICAL DIMENSIONS (mm)

Layout Dimension

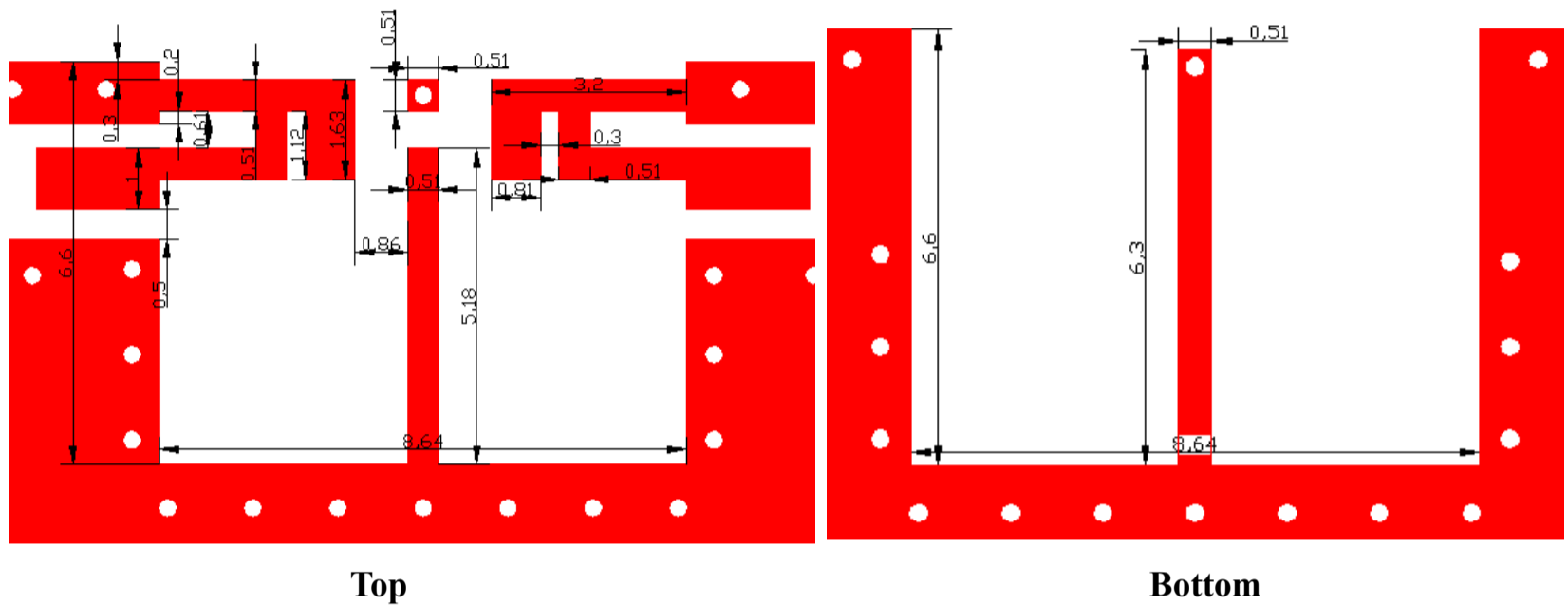

EVALUATION BOARD AND MATCHING CIRCUITS

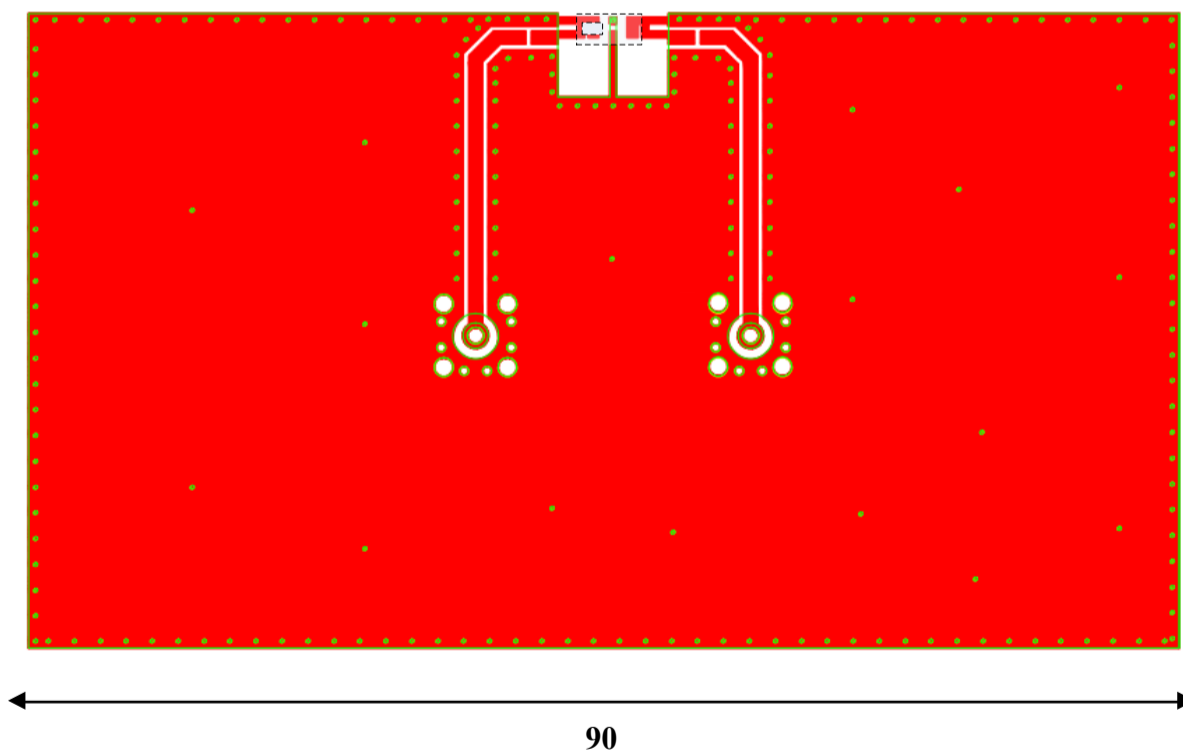

GPS

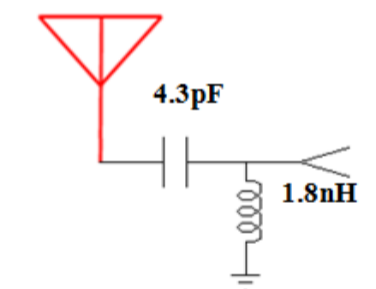

2.45G

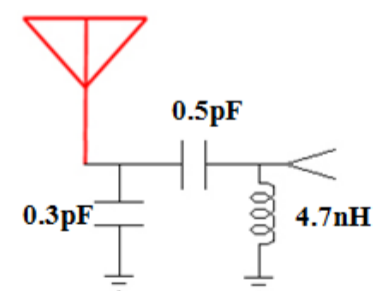

Unit: mm

WiFi + GPS Multiband Ceramic Chip Antenna

ACAG0301-15752450-T

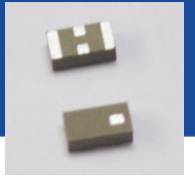

3.2 x 1.6 x 1.2mm
RoHS/RoHS II Compliant

MSL = 1

ANTENNA RESPONSE – RETURN LOSS S11

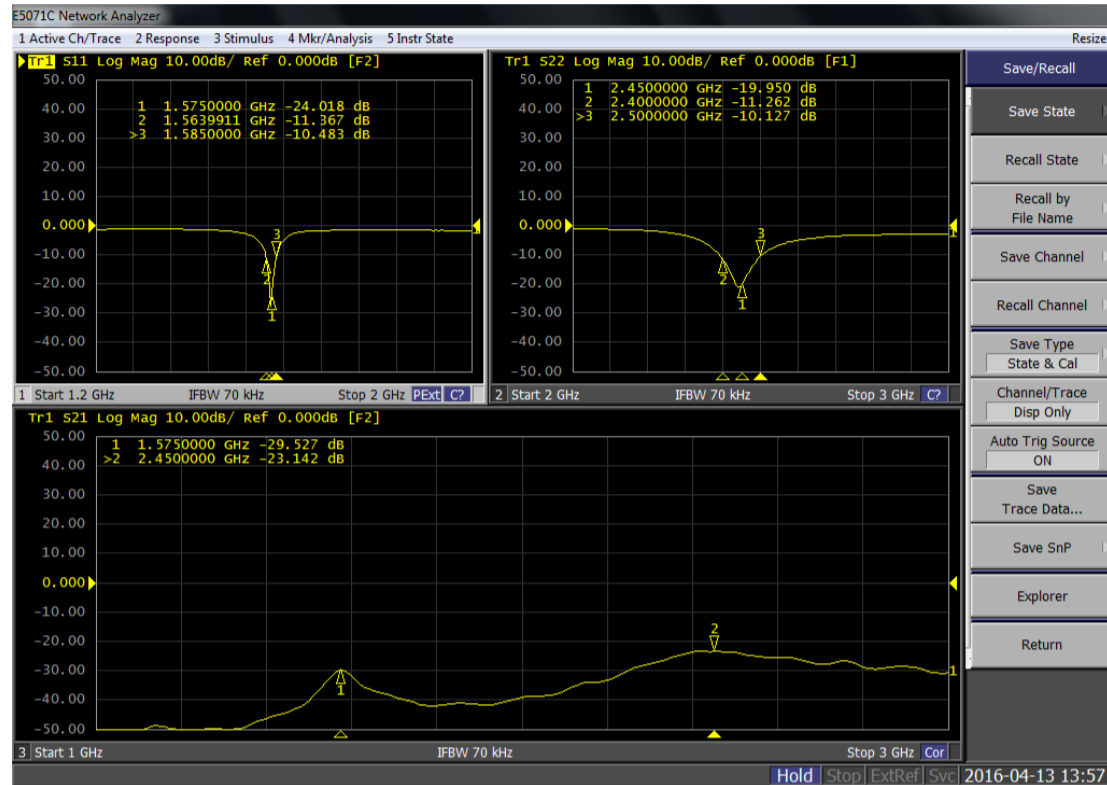

RADIATION PATTERNS

Coordinates

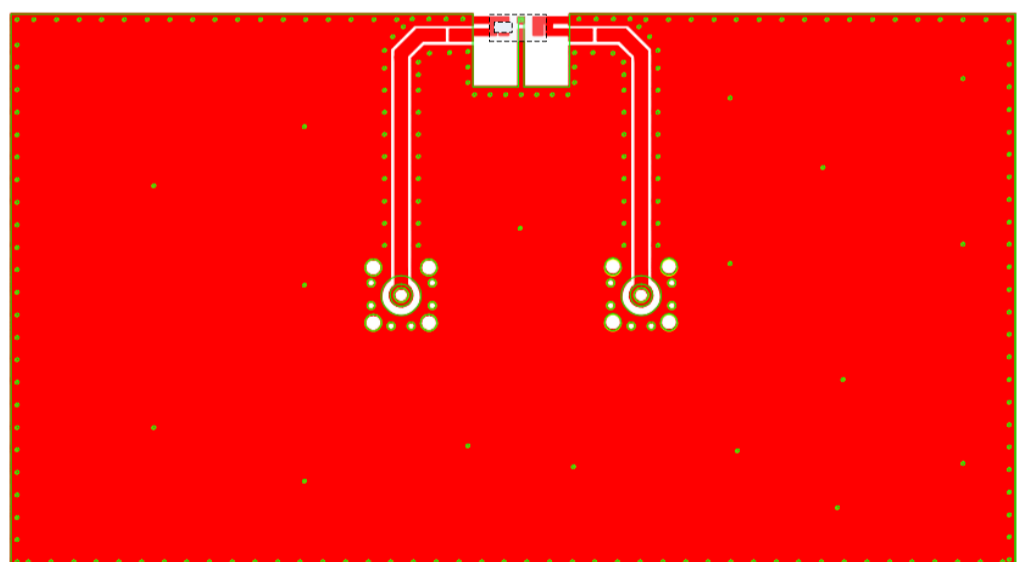
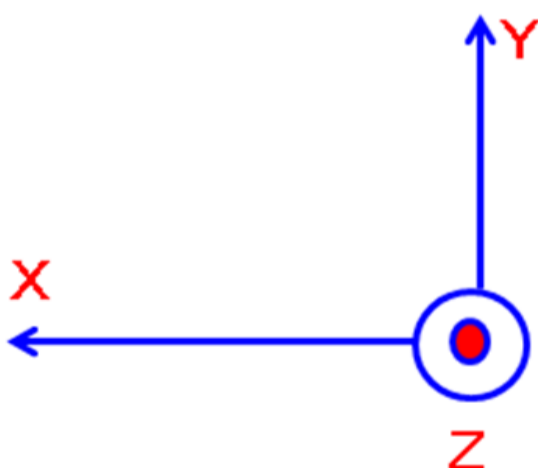

WiFi + GPS Multiband Ceramic Chip Antenna

ACAG0301-15752450-T

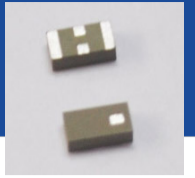

3.2 x 1.6 x 1.2mm
RoHS/RoHS II Compliant

MSL = 1

RADIATION PATTERNS

GPS X-Z Plane

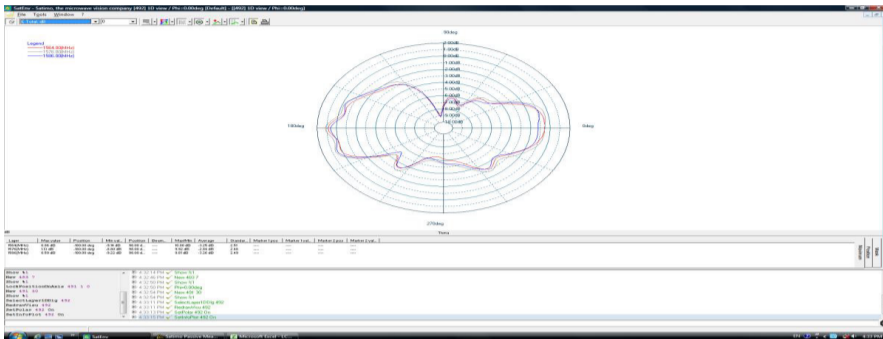

GPS Y-Z Plane

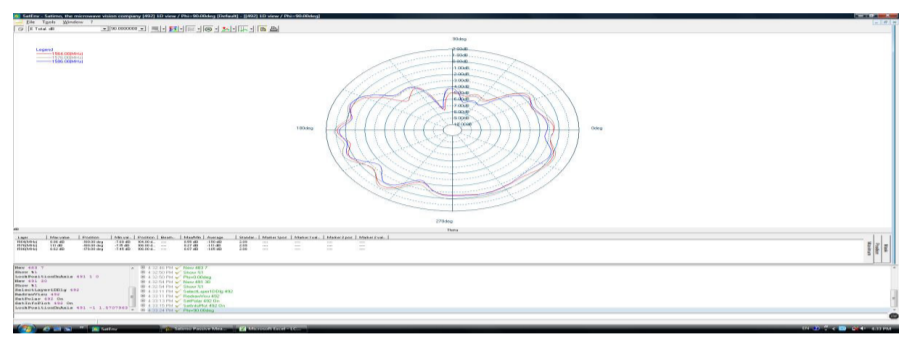

GPS X-Y Plane

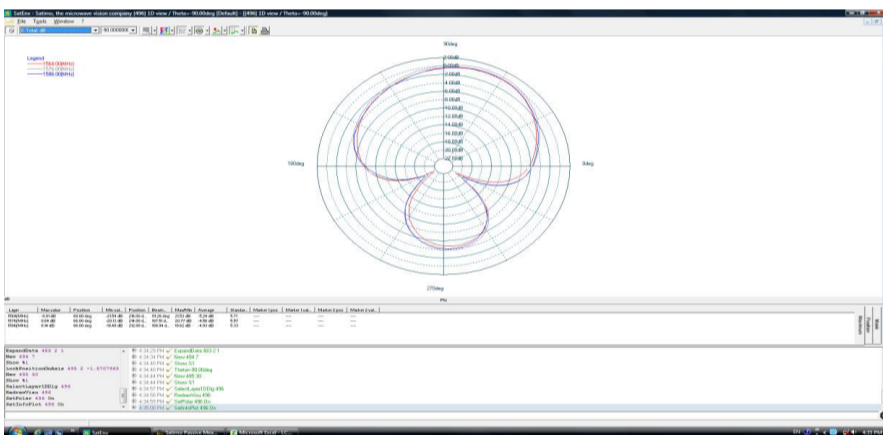

2.45G X-Z Plane

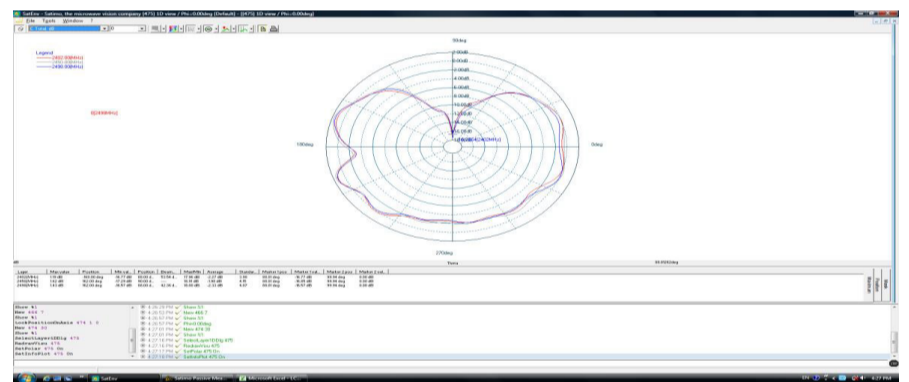

2.45G Y-Z Plane

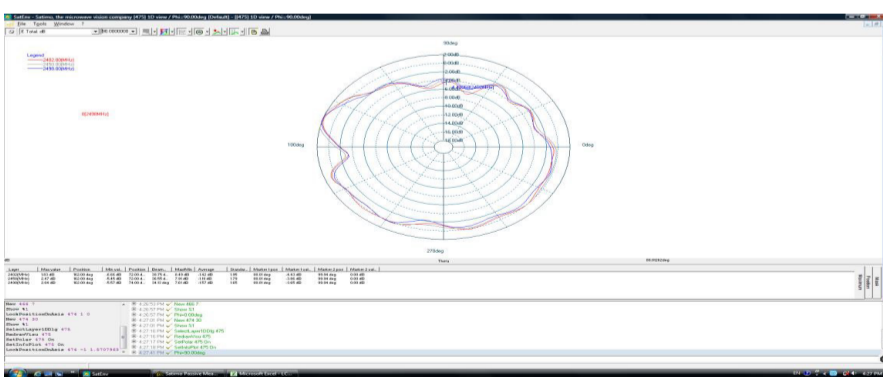

2.45G X-Y Plane

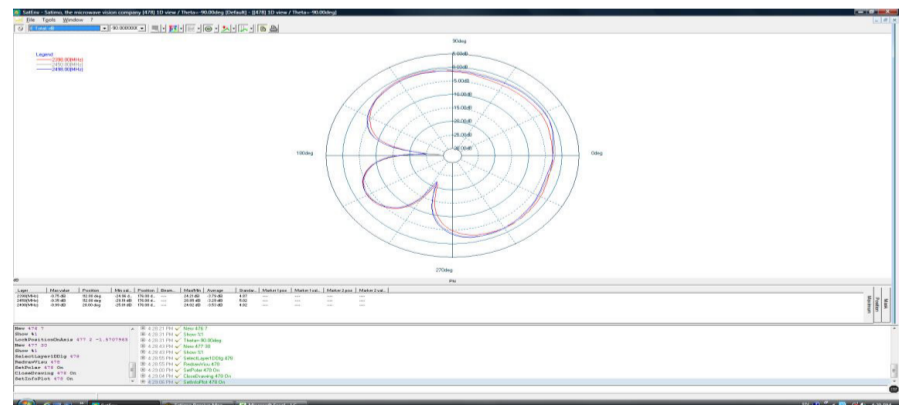

WiFi + GPS Multiband Ceramic Chip Antenna

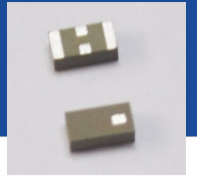

ACAG0301-15752450-T



3.2 x 1.6 x 1.2mm
RoHS/RoHS II Compliant

MSL = 1

3D PATTERNS

GPS

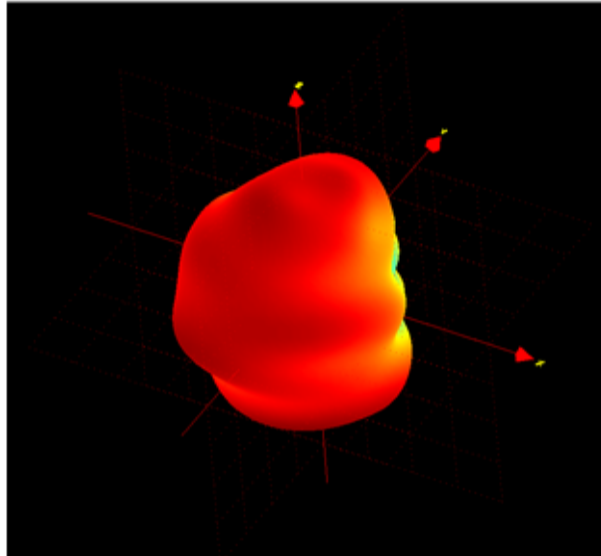

Frequency (MHz)	1565	1575	1585
Avg. Gain (dBi)	-1.5	-1.13	-1.65
Peak Gain (dBi)	1.05	1.21	1.13
Efficiency (%)	53	57	52

2.45 GHz

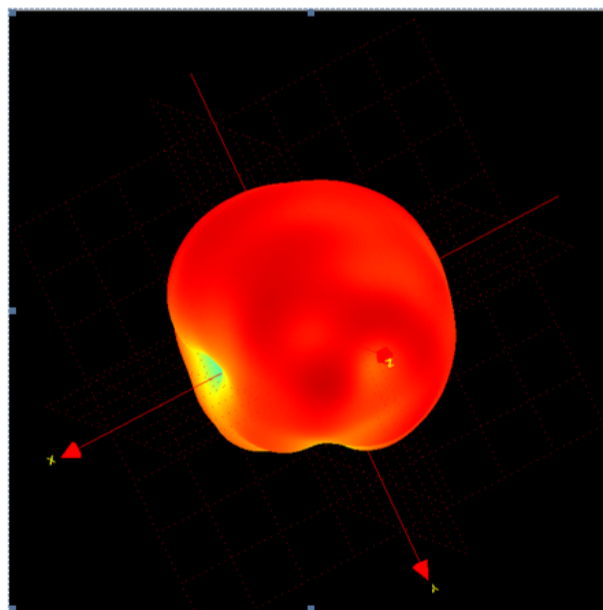

Frequency (MHz)	2400	2450	2500
Avg. Gain (dBi)	-1.42	-1.19	-1.57
Peak Gain (dBi)	2.87	3.18	2.96
Efficiency (%)	66	73	67

WiFi + GPS Multiband Ceramic Chip Antenna

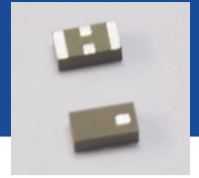

ACAG0301-15752450-T



3.2 x 1.6 x 1.2mm
RoHS/RoHS II Compliant

MSL = 1

REFLOW SOLDERING STANDARD CONDITION

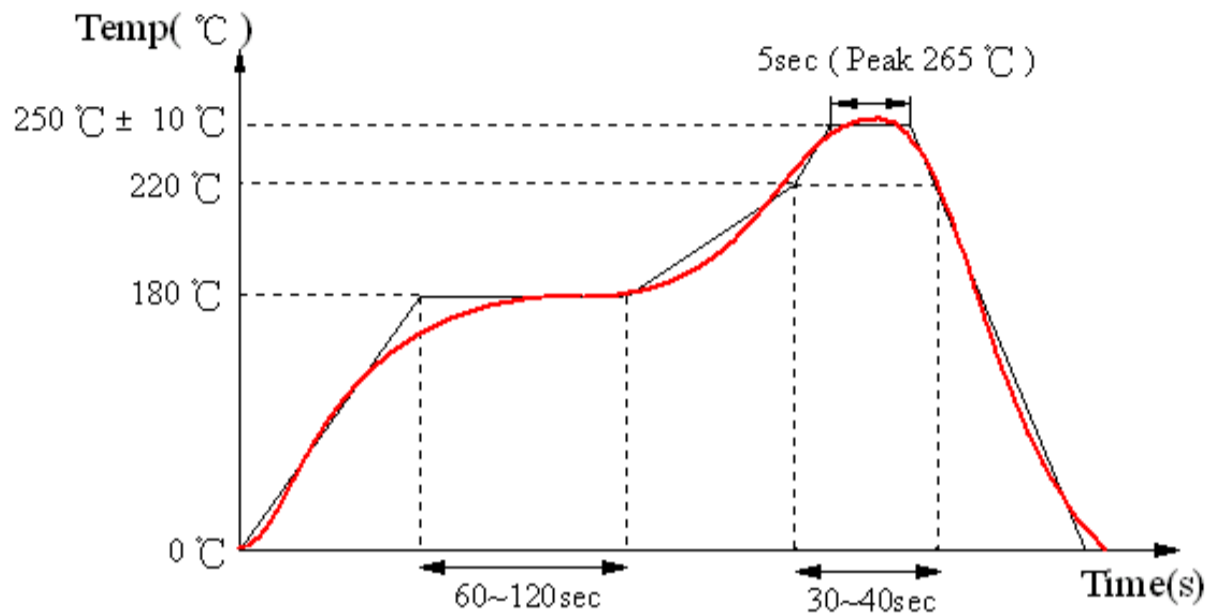

PACKAGING

Reel (3000 pcs/Reel)

Size of the carton: 330 x 210 x 210 mm

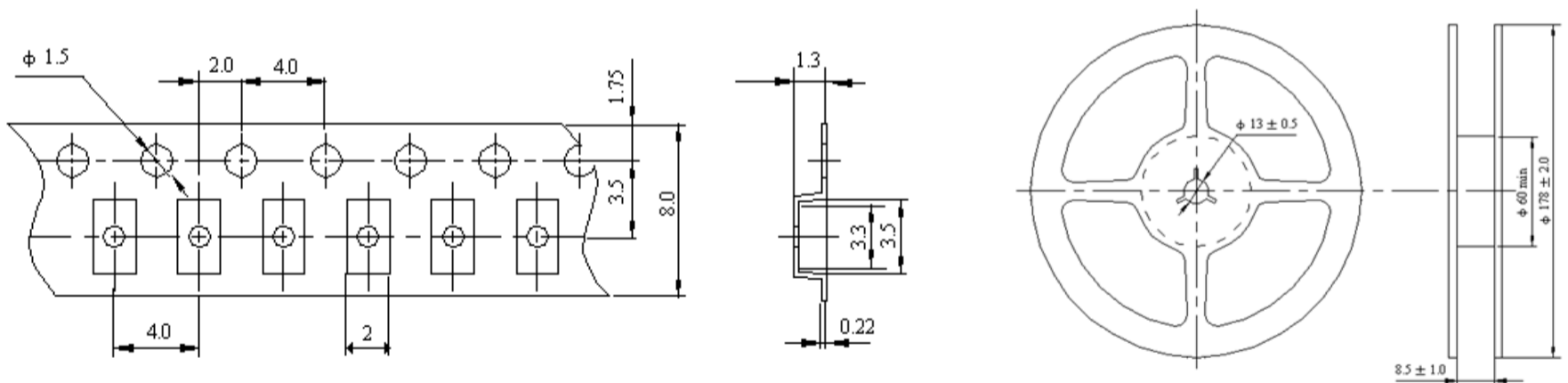

Dimensions: mm

Storage Temperature Range : <30 degree C, Humidity : <60%RH

MSL - 3

Oxidizable, 12 months in a vacuum sealed bag.

Once opened, please repack the unused items within 168 hours by re-seal package treatment.



5101 Hidden Creek Ln Spicewood TX 78669
Phone: 512-371-6159 | Fax: 512-351-8858
For terms and conditions of sales, please visit:
www.abracon.com

REVISED: 04.02.2019

ABRACON IS
ISO9001-2015
CERTIFIED

WiFi + GPS Multiband Ceramic Chip Antenna

ACAG0301-15752450-T

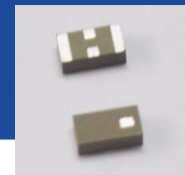

3.2 x 1.6 x 1.2mm
RoHS/RoHS II Compliant
MSL = 1

CAUTIONS

1. Static voltage

Static voltage between signal & ground may cause deterioration & destruction of the component. Please avoid static voltage.

2. Ultrasonic cleaning

Ultrasonic vibration may cause deterioration & destruction of the component. Please avoid ultrasonic cleaning.

3. Soldering

Only leads of the component may be soldered. Please avoid soldering to any other part of the component, such as on the patterns as this will change the performance of the antenna.

X-ON Electronics

Largest Supplier of Electrical and Electronic Components

Click to view similar products for [Antennas](#) category:

Click to view products by [ABRACON](#) manufacturer:

Other Similar products are found below :

[GAN30084EU](#) [930-033-R](#) [GW17.07.0250E](#) [1513563-1](#) [EXE902SM](#) [APAMPG-117](#) [MAF94383](#) [W3908B0100](#) [W6102B0100](#) [YE572113-30RSMM](#) [108-00014-50](#) [66089-2406](#) [A09-F8NF-M](#) [A09-F5NF-M](#) [RGFRA1903041A1T](#) [W3593B0100](#) [W3921B0100](#) [SIMNA-868](#) [SIMNA-915](#) [SIMNA-433](#) [W1044](#) [W1049B090](#) [A75-001](#) [WTL2449CQ1-FRSMM](#) [CPL9C](#) [EXB148BN](#) [0600-00060](#) [TRA9020S3PBN-001](#) [GD5W-28P-NF](#) [MA9-7N](#) [GD53-25](#) [GD5W-21P-NF](#) [EXB144SM](#) [C37](#) [MAF94051](#) [GD35-17P-NF](#) [P1744](#) [MA9-5N](#) [EXD420PL](#) [B1322NR](#) [QWFTB120](#) [MAF94271](#) [MAF94300](#) [GPSMB301](#) [FG4403](#) [AO-AGSM-OM54](#) [5200232](#) [MIKROE-2349](#) [WCM.01.0111](#) [MIKROE-2393](#)