

HIGH-CURRENT MULTILAYER FERRITE CHIP BEAD

ACML-0402H

RoHS
Compliant

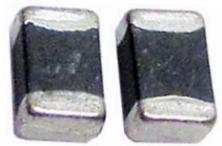

1.0 x 0.5 x 0.5mm

FEATURES:

- Multilayer monolithic structure yields high reliability
- Unique terminal electrode structure ensures permissible currents
- High impedance over a wide frequency range

TYPICAL APPLICATIONS:

- Video Equipment, Audio equipment
- Communication Equipment
- OA Equipment and other

STANDARD SPECIFICATIONS:

PARAMETERS	
ABRACON P/N:	ACML-0402H-xxx
Operating Temperature :	-55°C to +125°C
Storage Temperature:	-10°C to +40°C, 70% RH max

Part No.	Z (Ω) \pm 25%	Z Test Freq.	DCR (Ω)	Ir (mA)
		(MHz)	(max)	(max)
ACML-0402H-100	0~15	100	0.03	1000
ACML-0402H-300	30	100	0.06	700
ACML-0402H-400	40	100	0.12	550
ACML-0402H-700	70	100	0.10	700
ACML-0402H-800	80	100	0.16	450
ACML-0402H-121	120	100	0.20	500
ACML-0402H-221	220	100	0.30	400
ACML-0402H-241	240	100	0.40	400
ACML-0402H-301	300	100	0.50	300
ACML-0402H-421	420	100	0.52	300
ACML-0402H-471	470	100	0.45	250
ACML-0402H-501	500	100	0.50	250
ACML-0402H-601	600	100	0.55	300
ACML-0402H-751	750	100	0.65	150
ACML-0402H-102	1000	100	0.58	300
ACML-0402H-152	1500	100	1.20	100

Test Conditions and equipments

Z: High Accuracy RF Impedance Analyzer –HP4291B, Test Fixture: HP16192A, -20dBm or 50mV

DCR: High Accuracy Milliohmmeter –HP4338B

Ir: Electric Power Supply, Electric Current Meter, Thermometer. $\Delta T \leq 20^\circ\text{C}$

Unless otherwise specified, the standard atmospheric conditions for measurement/test as:

- a. Ambient Temperature: $20 \pm 15^\circ\text{C}$
- b. Relative Humidity: $65\% \pm 20\%$
- c. Air Pressure: 86 KPa to 106 KPa

Visual Examination

- a. Inspection Equipment: 20X magnifier

HIGH-CURRENT MULTILAYER FERRITE CHIP BEAD

ACML-0402H

RoHS
Compliant

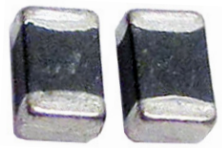

1.0 x 0.5 x 0.5mm

OPTIONS AND PART IDENTIFICATION

ACML-0402H- -

Impedance Code

Please refer to
Electrical Spec table

Packaging

T: Tape and Reel (10kpcs / reel)

FREQUENCY CHARACTERISTICS

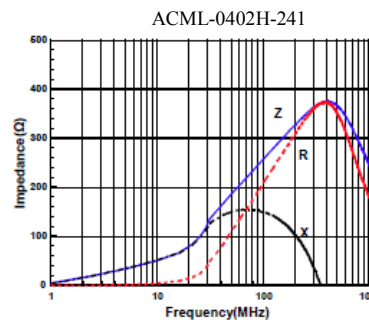
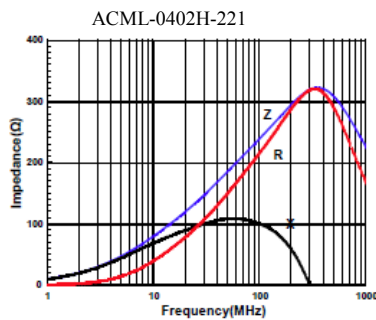
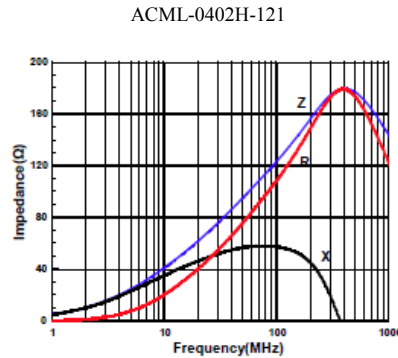
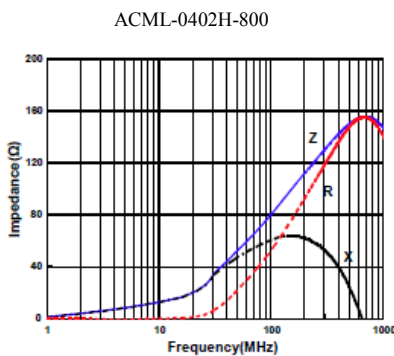
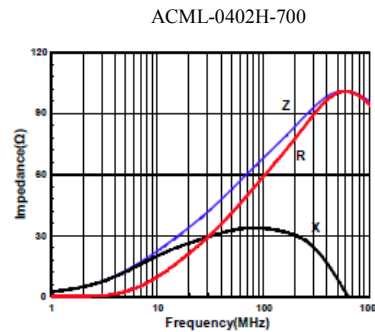
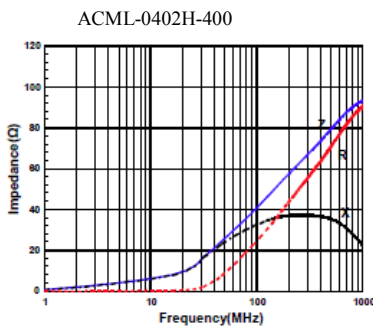
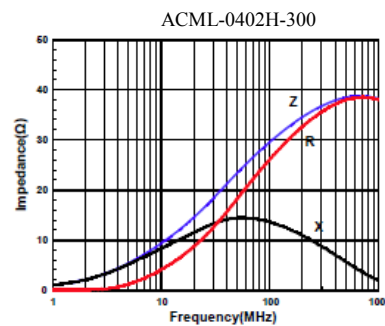
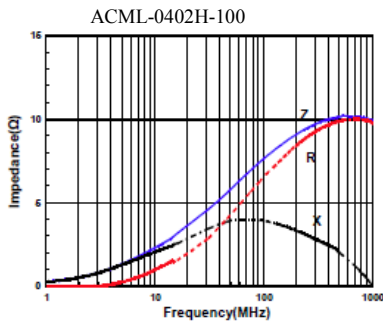

HIGH-CURRENT MULTILAYER FERRITE CHIP BEAD

ACML-0402H

RoHS
Compliant

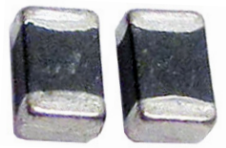

1.0 x 0.5 x 0.5mm

FREQUENCY CHARACTERISTICS

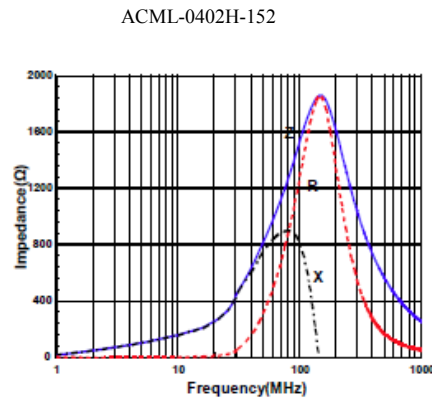
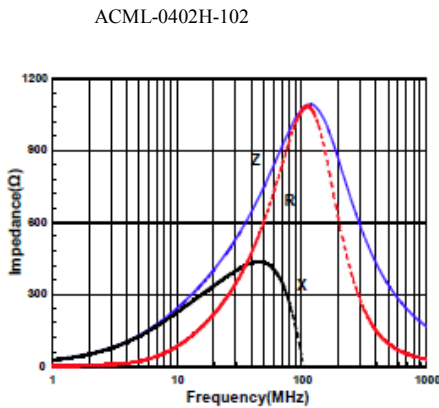
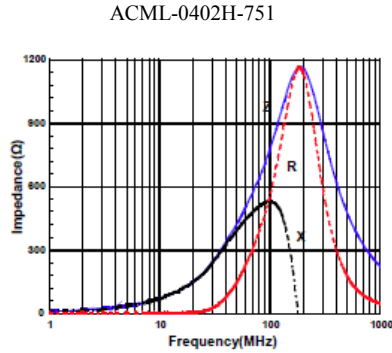
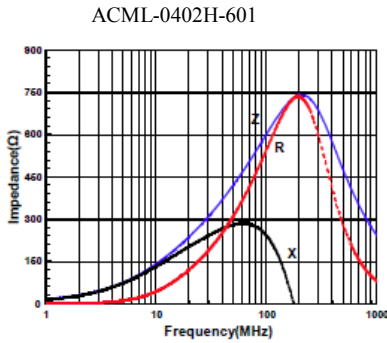
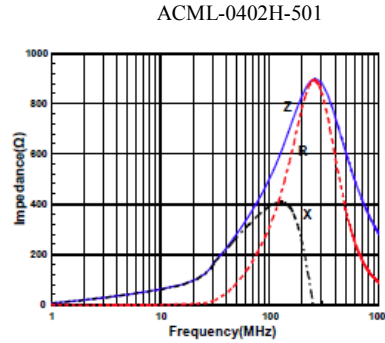
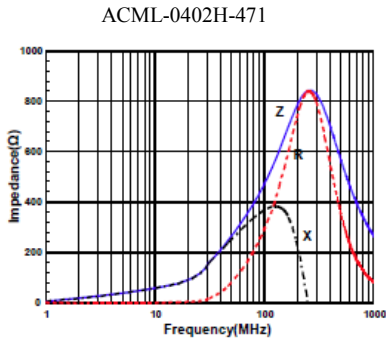
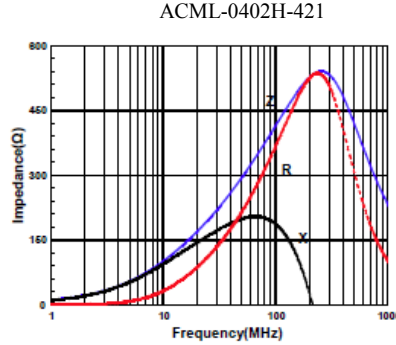
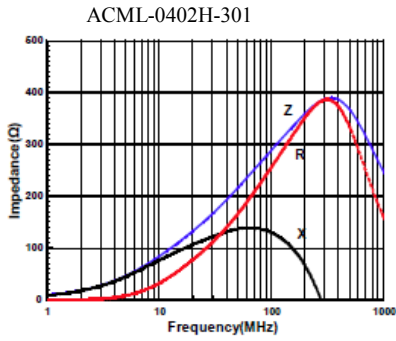

HIGH-CURRENT MULTILAYER FERRITE CHIP BEAD

ACML-0402H

RoHS
Compliant

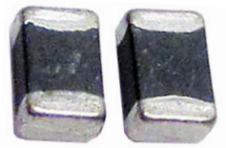

1.0 x 0.5 x 0.5mm

OUTLINE DRAWING:

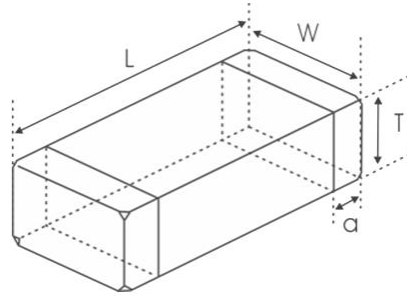

Series	L	W	T	a
ACML-0402H-xxx	1.0±0.15 [0.039±0.006]	0.5±0.15 [0.020±0.006]	0.5±0.15 [0.020±0.006]	0.25±0.10 [0.010±0.004]

Recommended Land Pattern

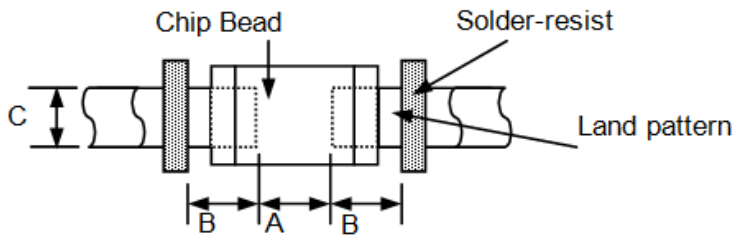

A	B	C
0.45~0.55	0.40~0.50	0.45~0.55

Dimension: mm [inch]

Materials

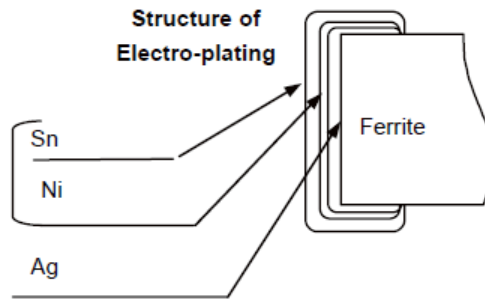
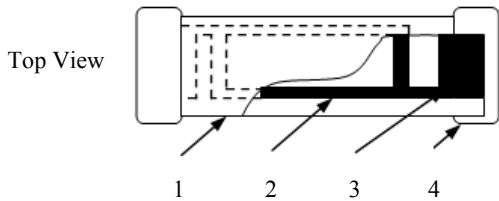
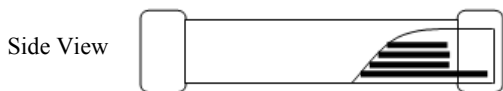

	Part Name	Material
1	Base Material	Ferrite
2	Internal Conductor	Ag
3	Pull out Electrode	Ag
4	Terminal Electrode	Ag (Inner layer) Ni-Sn (Outer layer)

HIGH-CURRENT MULTILAYER FERRITE CHIP BEAD

ACML-0402H

RoHS
Compliant

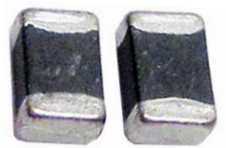

1.0 x 0.5 x 0.5mm

REFLOW PROFILE:

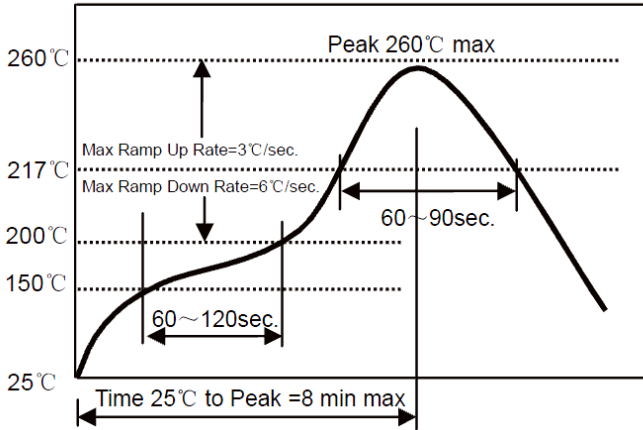

Preheat Condition	150 to 200 °C; 60 to 120 sec.
Allowed time above 217 °C	60 to 90 sec.
Max temperature	260 °C
Max time at max temperature	10 sec.
Solder paste	Sn/3.0Ag/0.5Cu
Allowed Reflow time	2x max.

TAPE & REEL:

Packing

T: 10,000pcs / reel

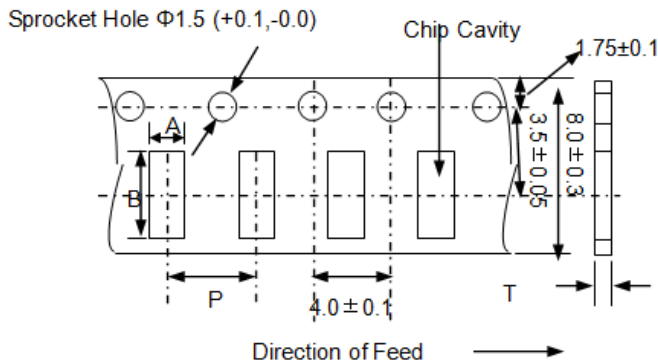

A	B	P	t(max)
0.65±0.10	1.15±0.10	2.0±0.05	0.80

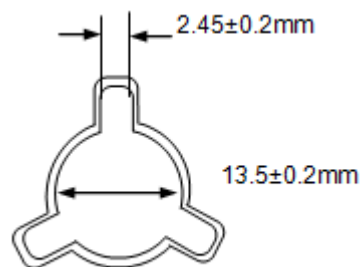
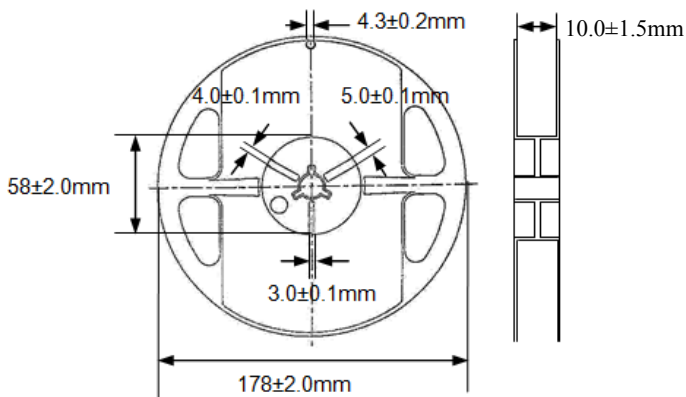

Dimension: mm

X-ON Electronics

Largest Supplier of Electrical and Electronic Components

Click to view similar products for [Ferrite Beads](#) category:

Click to view products by [ABRACON](#) manufacturer:

Other Similar products are found below :

[CZB1EGTTP700P](#) [CZB1JGTTD101P](#) [CZB1JGTTD151P](#) [CZB1JGTTD601P](#) [CZB2AFTTD800P](#) [CZB2AGTTD601P](#) [CZB2BFTTE600P](#) [PE-0402FB121ST](#) [EMI0805R-11](#) [NCB0603R301TR050F](#) [NCB0805A320TR050F](#) [NCB-H1206B680TR300F](#) [SMB2.5-1TR](#) [SMB2.5R-2](#)
[2943778301](#) [CZB1EGTTP121P](#) [CZB1JGTTD102P](#) [CZB1JGTTD121P](#) [CZB1JGTTD221P](#) [CZB2AGTTD301P](#) [CZB2BFTTE601P](#) [4221R-1](#)
[4221R-2](#) [4221R-3](#) [EMI0805R-2000](#) [EMI0805R-600](#) [SBY100505T-100Y-N](#) [NCB-GH0402D121TR060F](#) [NCB-H1812D125TR150F](#)
[CZB2AGTTD102P](#) [NCB0402P301TR005F](#) [NCB0603R152TR030F](#) [NCB0805A121TR050F](#) [NCB3312K900TR500F](#) [NCB-H0805A221TR300F](#) [NCB-H1806E181TR300F](#) [NCB0402P300TR030F](#) [NCB0402P700TR050F](#) [NCB0805A102TR040F](#)
[NCB1806E151TR020F](#) [NCB-H0603R121TR300F](#) [NCB-H0805A220TR600F](#) [NCB-H0805A390TR400F](#) [CIM21J252NE](#) [CZB2BFTTE121P](#)
[EMI0805R-220](#) [74279250](#) [7427924](#) [CZB1JGTTD202P](#) [ABUPDE160808121Y00](#)