

MULTILAYER FERRITE CHIP BEAD

ACML-0603



RoHS/RoHS II Compliant



1.60 x 0.80 x 0.80mm

FEATURES:

- Magnetic shielded structure designed to minimize crosstalk
- Multilayer monolithic structure yields high reliability
- Substantial EMI suppression from dozens of MHz to hundreds of MHz
- Wide range of impedance values available

APPLICATIONS:

- Noise suppression in digital equipment such as computer and its peripheral devices, DVD player, digital camera, TV and communication equipments.

STANDARD SPECIFICATIONS:

PARAMETERS

ABRACON P/N:	ACML-0603
Operating temperature:	-55°C to +125°C
Storage temperature:	-55°C to +125°C

Part Number ACML-0603- Impedance Code	Impedance	Frequency	DC resistance	Rated Current
Units	$\Omega \pm 25\%$	MHz	Ω max	mA max
Symbol	Z	F	R _{DC}	I _R
ACML-0603-060	6	100	0.05	1000
ACML-0603-110	11	100	0.05	1000
ACML-0603-190	19	100	0.05	1000
ACML-0603-220	22	100	0.20	800
ACML-0603-310	31	100	0.05	500
ACML-0603-500	50	100	0.08	500
ACML-0603-600	60	100	0.30	600
ACML-0603-800	80	100	0.16	200
ACML-0603-101	100	100	0.20	200
ACML-0603-121	120	100	0.40	600
ACML-0603-181	180	100	0.30	200
ACML-0603-221	220	100	0.45	500
ACML-0603-301	300	100	0.35	200
ACML-0603-331	330	100	0.50	500
ACML-0603-471	470	100	0.55	400
ACML-0603-501	500	100	0.45	200
ACML-0603-601	600	100	0.45	200
ACML-0603-102	1000	100	0.80	200
ACML-0603-152	1500	100	0.80	200
ACML-0603-202	2000	100	1.00	200

Test Conditions and Equipments

I_R: Rated current applied when the chip surface temperature rise just 20°C against chip surface temperature.

Electric power supplier, Electric current meter, Thermometer.

Z: Impedance Analyzer HP4291 or equivalent, 50mV.

DCR: LCR Meter HP4263A or equivalent



MULTILAYER FERRITE CHIP BEAD

ACML-0603



RoHS/RoHS II Compliant



1.60 x 0.80 x 0.80mm

FREQUENCY CHARACTERISTICS

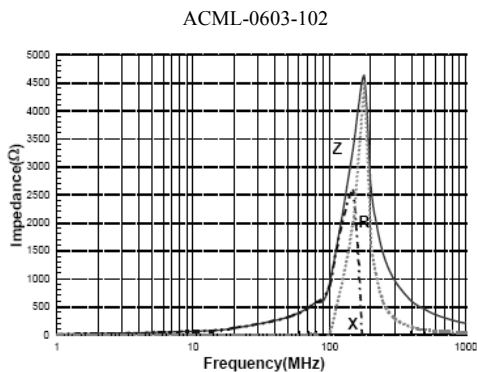
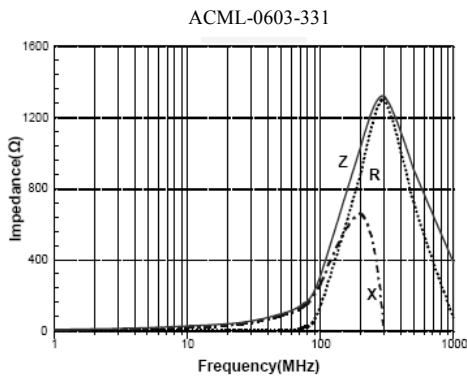
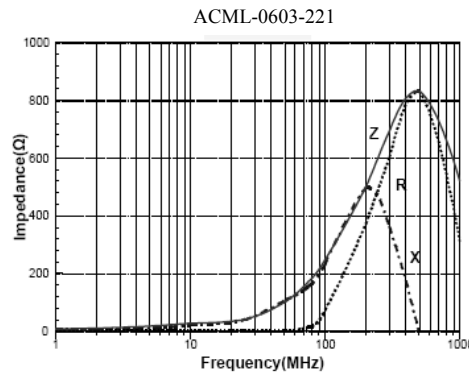
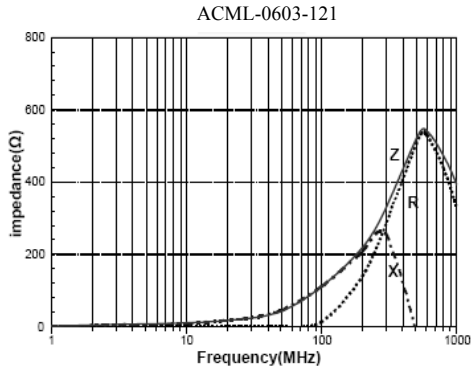
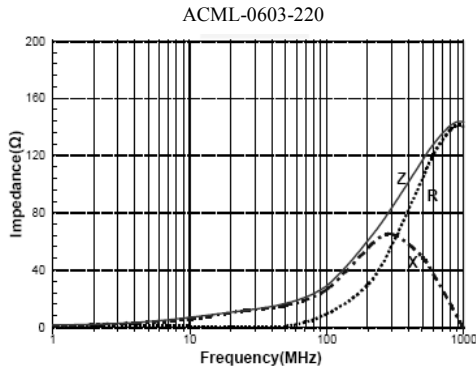

MULTILAYER FERRITE CHIP BEAD

ACML-0603



RoHS/RoHS II Compliant



1.60 x 0.80 x 0.80mm

PART NUMBER IDENTIFICATION

ACML-0603- -

Impedance Code

Please refer to the Electrical Specification table

Packaging

T: Tape and Reel
(4kpcs / reel)

OUTLINE DIMENSION:



L	W	T	a1, a2
1.60±0.15	0.80±0.15	0.80±0.15	0.30±0.20

Materials

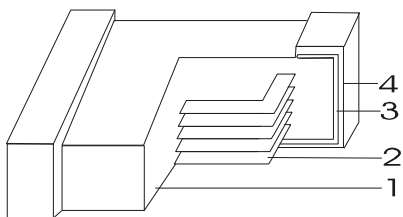

	Part Name	Material
1	Base Material	Ferrite
2	Internal Conductor	Ag
3	Terminal Electrode	Ag
4	Terminal Electrode	Ni-Sn

Dimension: mm

MULTILAYER FERRITE CHIP BEAD

ACML-0603



RoHS/RoHS II Compliant

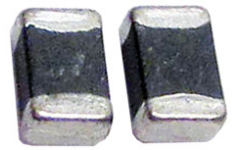

1.60 x 0.80 x 0.80mm

REFLOW PROFILE:

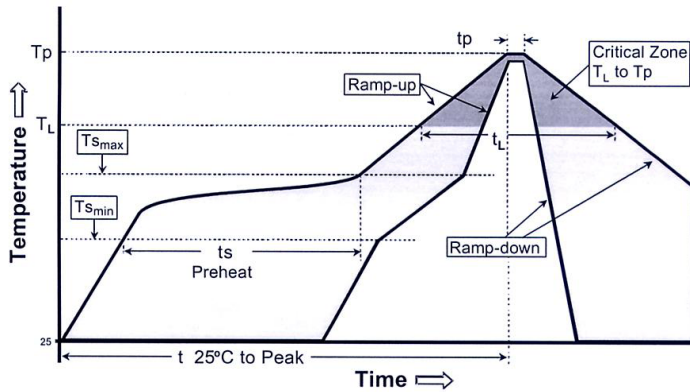

Profile Feature	Lead-Free Assembly
Average Ramp-Up Rate (T_{smax} to T_p)	3°C/second max.
Preheat - Temperature Min (T_{smin}) - Temperature Max (T_{smax}) - Time (t_{smin} to t_{smax})	150 °C 200 °C 60-180 seconds
Time maintained above: - Temperature (T_l) - Time (t_l)	217 °C 60-150 seconds
Peak/Classification Temperature (T_p) Peak/Classification Time (t_p)	260 °C 3-4 seconds
Time within 5 °C of actual Peak Temperature (t_p)	20-40 seconds
Ramp-Down Rate	6°C/second max.
Time 25 °C to Peak Temperature	8 minutes max.

TAPE & REEL:

Packing

T= tape and reel (4,000 pcs/reel)

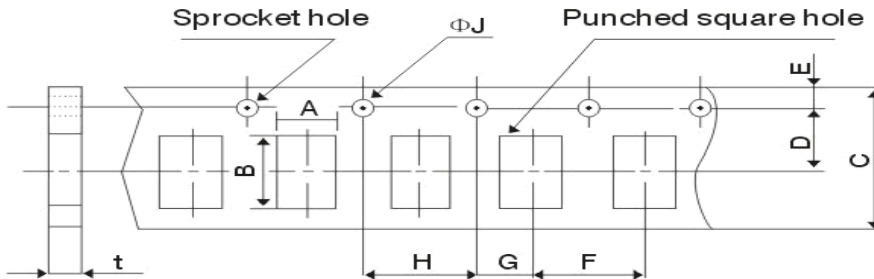

A	1.05±0.15
B	1.9±0.15
C	8.0±0.3
D	3.5±0.05
E	1.75±0.1
F	4.0±0.1
G	2.0±0.05
H	4.0±0.1
ΦJ	1.5+0.1/-0
t(max)	1.0±0.05

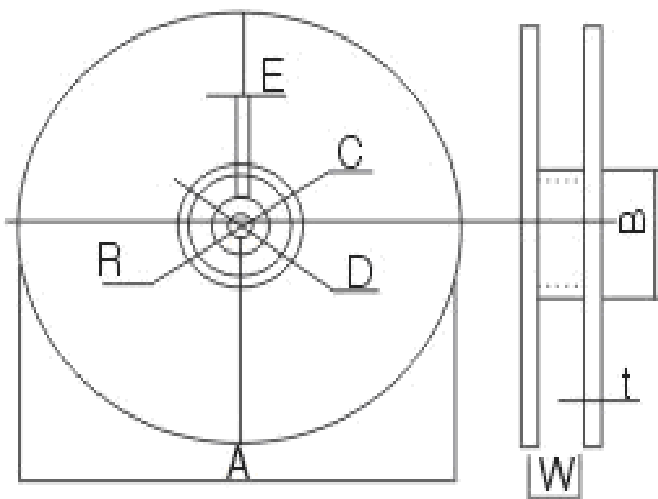

A	178±2
B	60±2
C	13.0±0.5
D	21.0±0.8
E	2.0±0.5
W	10.0±1.15
t	1.2±0.2
R	1.0±0.25

Dimension: mm

ATTENTION: Abracon Corporation's products are COTS – Commercial-Off-The-Shelf products; suitable for Commercial, Industrial and, where designated, Automotive Applications. Abracon's products are not specifically designed for Military, Aviation, Aerospace, Life-dependant Medical applications or any application requiring high reliability where component failure could result in loss of life and/or property. For applications requiring high reliability and/or presenting an extreme operating environment, written consent and authorization from Abracon Corporation is required. Please contact Abracon Corporation for more information.

ABRACON IS
ISO 9001:2008
CERTIFIED



Visit www.abracon.com for Terms & Conditions of Sale **Revised: 01.19.14**
30332 Esperanza, Rancho Santa Margarita, California 92688
tel 949-546-8000 | fax 949-546-8001 | www.abracon.com

X-ON Electronics

Largest Supplier of Electrical and Electronic Components

Click to view similar products for [ABRACON](#) manufacturer:

Other Similar products are found below :

[AISC-1812H-470K-T](#) [ASGTX-BLANK](#) [ABLJO-V-155.520MHZ](#) [ABLNO-122.880MHZ](#) [ABLNO-V-96.000MHZ](#) [ABLS-10.240MHZ-B4-T](#)
[ABM3B-26.000MHZ-10-D-1-G-T](#) [AOCJY3-40.000MHZ-E](#) [ARRSN5-868.000MHZ](#) [ASEMB-80.000MHZ-XY-T](#) [ASGTX-P-1.000GHz-1](#)
[AST3TQ-T-24.576MHZ-50-C](#) [ASTMLPD-24.000MHZ-LJ-E-T](#) [ABLJO-V-150.000MHZ](#) [ABM2-16.000MHZ-D4Y-T](#) [ABM8G-12.000MHZ-](#)
[B4Y-T3](#) [AIRD-06-101K](#) [AOCJY6-10.000MHZ-1](#) [ASFLMB-48.000MHZ-LY-T](#) [ASG-C-V-A-50.000MHZ](#) [ASHEK2-32.768KHZ-LT](#) [AXS-](#)
[5032-04-12](#) [ABM8X-101-24.000MHZ-T](#) [AIML-0805-470K-T](#) [AOCJY3A-10.000MHZ-E](#) [ASFL1-50.000MHZ-EK-T](#) [AOCTQ5-X-](#)
[10.000MHZ-M10-SW](#) [ASPI-0705-820K-T](#) [AMPMAFB-19.2000T](#) [ABL-10.000MHZ-D-T](#) [ABM3B-27.120MHZ-10-D2H-T](#) [AOC2012XAJC-](#)
[12.8000C](#) [EP1400SJETTSC-11.0592M](#) [EP1400SJETTSC-2.000M](#) [EHH1100TS-13.560M](#) [ABL-16.384MHZ-B2](#) [AIRD-01-680K](#) [AOCJY-](#)
[10.000MHZ](#) [AOCJY2-10.000MHZ](#) [AOCJY-38.880MHZ-F](#) [AOCJY3A-100.000MHZ-E](#) [ASG2-D-X-A-1000.000MHZ](#) [ASG-D-X-A-](#)
[200.000MHZ](#) [ASGTX-P-1.500GHz-1](#) [AXS-3225-04-04](#) [AXS-3225-04-10](#) [AXS-5032-04-02](#) [AXS-7550-06-05](#) [ABLJO-92.160MHZ](#) [ABLS-](#)
[6.7458MHZ-20-R60-D-T](#)