

Power Common Mode choke



ACMP-4724 Series

Request Samples



Check Inventory



4.7 x 4.5 x 2.4 mm
RoHS/RoHS II Compliant
MSL Level = 1

Features

- Commercial Grade
- PPAP ready and supported
- Excellent impedance characteristics
- Rated current up to 3.2A
- Extremely Low DCR

Applications

- DC power line common mode noise suppression.
- Switch Mode Power Supplies and regulators
- Variable Frequency Drives
- AC/DC power rectifiers

Electrical Specifications

Part Number	Impedance (Ω) @100MHz		DCR (m Ω)	Rated Current (A)	Rated Voltage (Vdc)	Insulation Resistance (M Ω)
	Min	Typ.	Max	Typ.	Max	Min
ACMP-4724-900	30	90	35	3.2	50	10
ACMP-4724-151	80	150	38	3.1	50	10
ACMP-4724-231	180	230	39	3.0	50	10
ACMP-4724-301	180	300	39	3.0	50	10
ACMP-4724-401	200	400	50	2.5	50	10
ACMP-4724-501	300	500	55	2.4	50	10
ACMP-4724-701	500	700	59	2.2	50	10
ACMP-4724-901	700	900	68	2.1	50	10
ACMP-4724-102	800	1000	68	2.1	50	10
ACMP-4724-122	1000	1200	74	2.0	50	10
ACMP-4724-142	1200	1400	81	1.9	50	10

Rated Current is based on an Irms temperature rise of 40°C

Operating Temperature: -40°C to +125°C (Including self-heating)

Storage (in original packaging): <40°C, <70% RH

ACMP-4724 Series is [RoHS Compliant and Pb free](#)

Power Common Mode choke



ACMP-4724 Series

Request Samples



Check Inventory



4.7 x 4.5 x 2.4 mm
RoHS/RoHS II Compliant
MSL Level = 1

Electrical Specifications

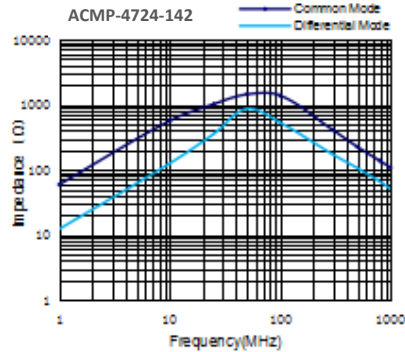
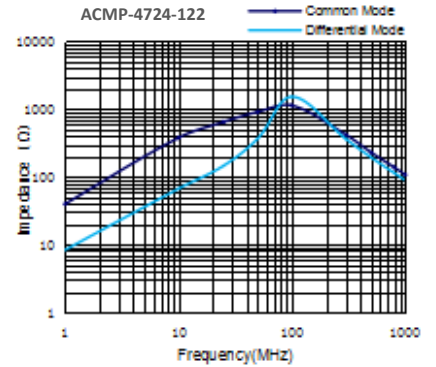
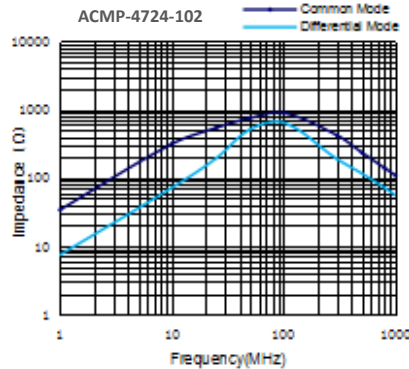
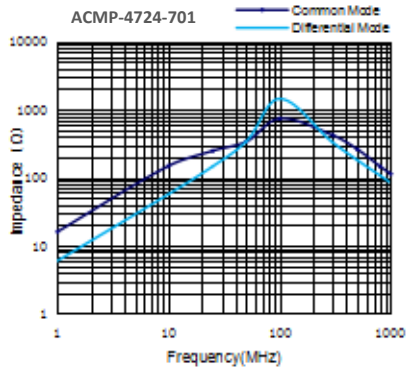
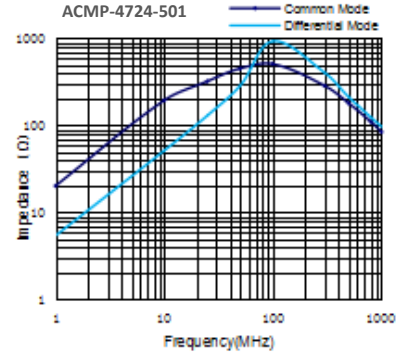
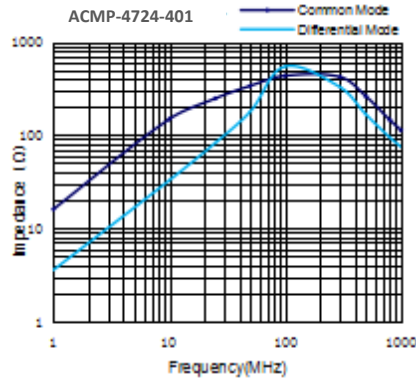
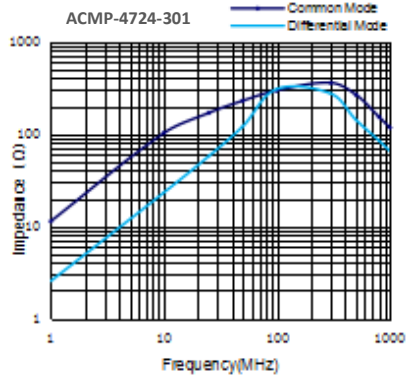
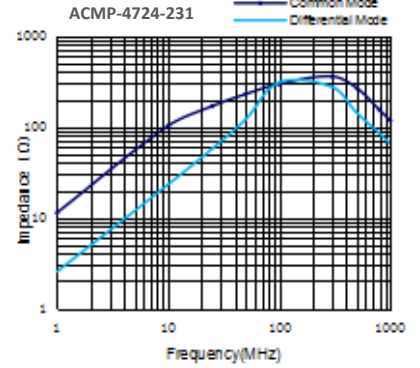
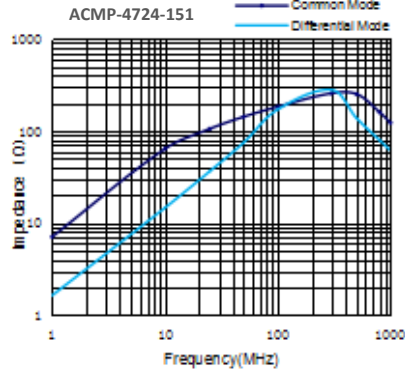
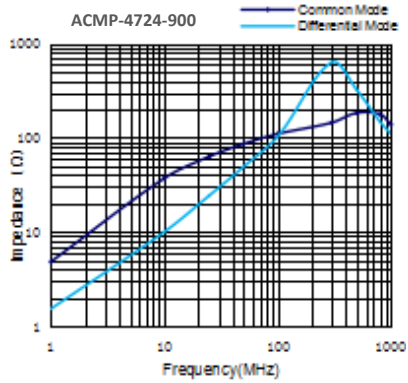

Power Common Mode choke



ACMP-4724 Series

Request Samples

Check Inventory

4.7 x 4.5 x 2.4 mm
 RoHS/RoHS II Compliant
 MSL Level = 1

Mechanical Specifications

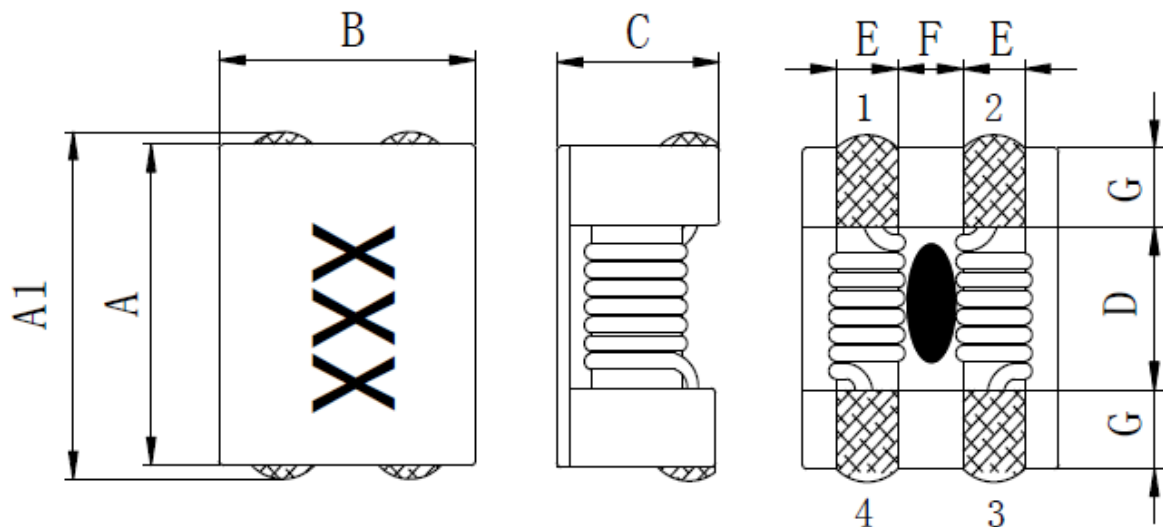

A	A1	B	C	D	E	F	G
4.7 ± 0.5	5.2 ± 0.6	4.5 ± 0.5	2.4 MAX	2.7 Ref.	0.75 Ref	1.25 Ref.	1 Ref.

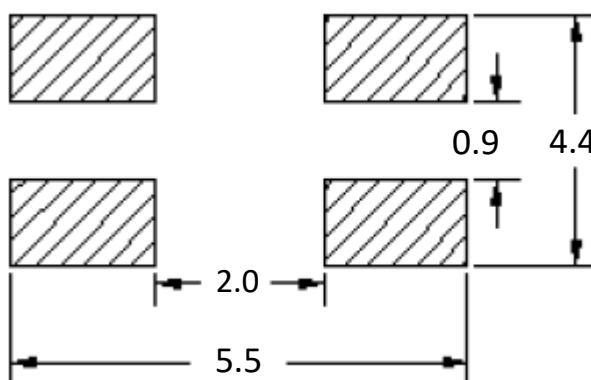

Recommended Layout

Dimensions: mm

Power Common Mode choke



ACMP-4724 Series

Request Samples



Check Inventory



4.7 x 4.5 x 2.4 mm
RoHS/RoHS II Compliant
 MSL Level = 1

Schematic

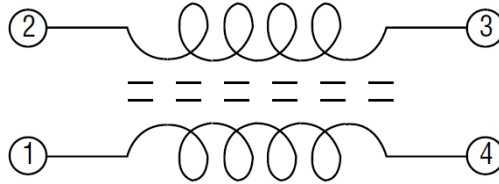

Materials

Description	Specification
Core	Ferrite core
Wire	Enameled copper wire
Base	Plastic
Adhesive	Epoxy resin
Terminal	Sn/Cu
Ink	White

Part Identification

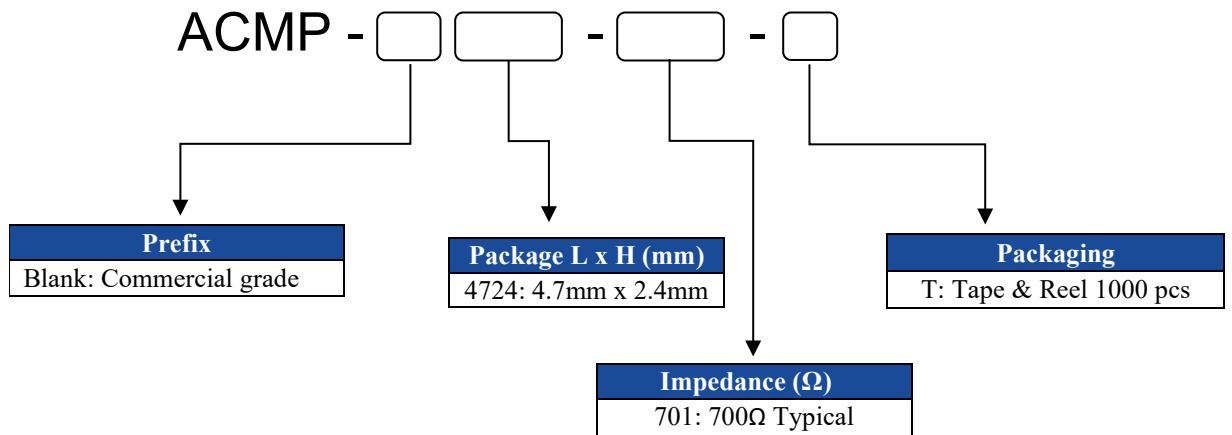

Power Common Mode choke



ACMP-4724 Series

Request Samples



Check Inventory



4.7 x 4.5 x 2.4 mm
RoHS/RoHS II Compliant
MSL Level = 1

Reflow Profile

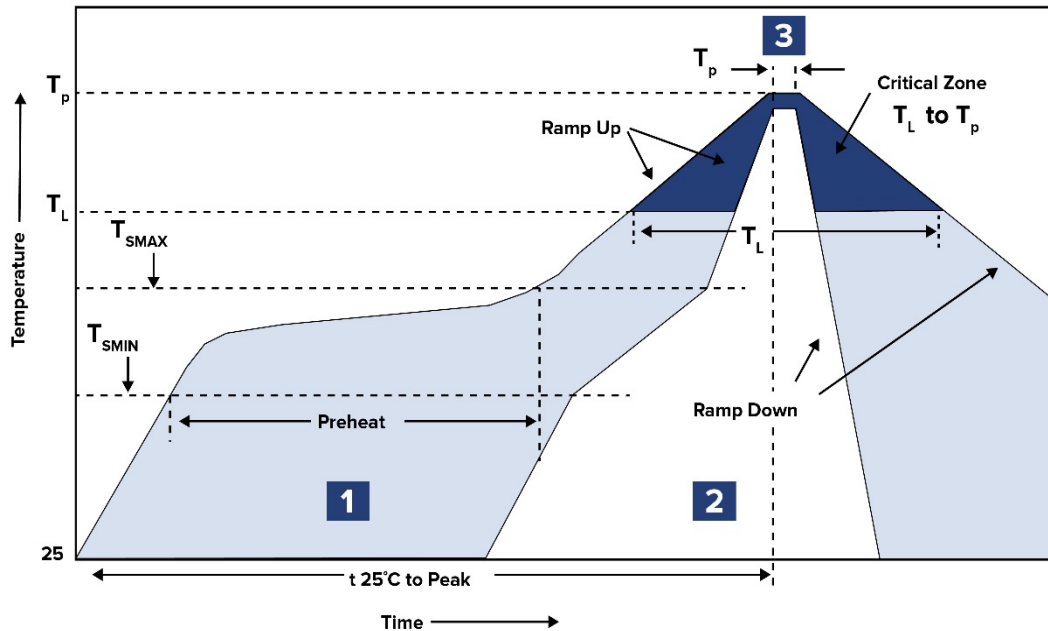

Zone	Description	Temperature	Times
1	Preheat	$T_{SMIN} \sim T_{SMAX}$ 150°C ~ 190°C	60 ~ 120 sec.
2	Reflow	T_L 240°C	20 ~ 40 sec.
3	Peak heat	T_P 260°C Max.	5 sec. Max

1~2 °C/Sec. Ramp

Power Common Mode choke



ACMP-4724 Series

Request Samples



Check Inventory



4.7 x 4.5 x 2.4 mm
RoHS/RoHS II Compliant
MSL Level = 1

Packing

Tape & Reel: 1000pcs/reel

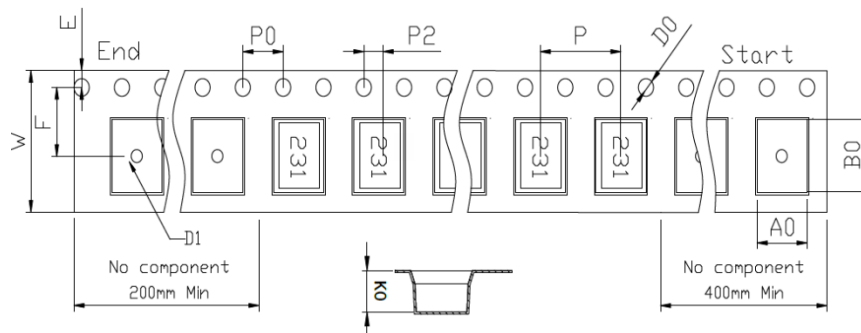
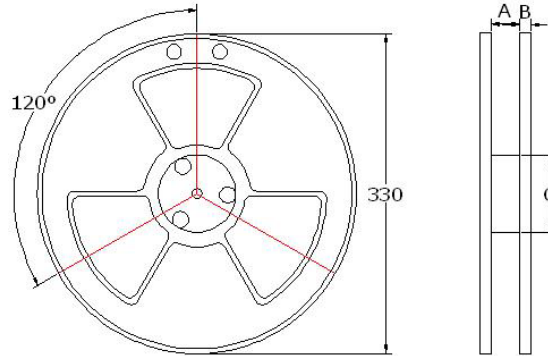

W	P	P0	P2	D0	E	F	A0	B0	K0
12 ± 0.30	8.0 ± 0.10	4.0 ± 0.10	2.0 ± 0.10	1.5 ± 0.10	1.75 ± 0.10	5.5 ± 0.10	5.0 ± 0.10	5.2 ± 0.10	2.5 ± 0.10

Dimensions: mm

ATTENTION: Abracon LLC's products are COTS – Commercial-Off-The-Shelf products; suitable for Commercial, Industrial and, where designated, Automotive Applications. Abracon's products are not specifically designed for Military, Aviation, Aerospace, Life-dependent Medical applications or any application requiring high reliability where component failure could result in loss of life and/or property. For applications requiring high reliability and/or presenting an extreme operating environment, written consent and authorization from Abracon LLC is required. Please contact Abracon LLC for more information.



5101 Hidden Creek Ln Spicewood TX 78669
 Phone: 512-371-6159 | Fax: 512-351-8858
 For terms and conditions of sales, please visit:
www.abracon.com

REVISION: IR 06-29-22

ABRACON IS
 ISO9001-2015
 CERTIFIED

X-ON Electronics

Largest Supplier of Electrical and Electronic Components

Click to view similar products for [Common Mode Chokes / Filters](#) category:

Click to view products by [Abracon](#) manufacturer:

Other Similar products are found below :

[PE-64683](#) [RD5122-6-9M6](#) [ST6118T-R](#) [FE3X025-10-7NL](#) [T8114NLT](#) [TCM0806G-350-2P-T](#) [TCM0806G-650-2P-T](#) [IND-0110](#)
[UAL21VR0802000](#) [UALSC023000000](#) [UALSC1020JH000](#) [UALSU10VD20010](#) [UALSU9VD070100](#) [36-00037](#) [CM7060M132R-10](#)
[UALW21HS072450](#) [UALSU9H0208000](#) [UAL24VK06450CH](#) [PE-67531](#) [TLH10UB](#) [113 OR5](#) [2752045447](#) [CM8663Z161B-10](#) [7351V](#)
[CMF16-153131](#) [T8116NLT](#) [CMS2-10-R](#) [FE2X10-4-2NL](#) [T8003NLT](#) [CTX01-13663](#) [CTX66-19521-R](#) [RC212-0.5-10M](#) [RC112-0.4-15M](#)
[RC212-0.6-6M8](#) [RC212-0.4-15M](#) [RC112-0.3-30M](#) [4534-3](#) [WTCF2012Z0M751PB](#) [PH9408.814NLT](#) [B82498B3221J000](#) [PAC6006.364NLT](#)
[PAC6006.444NLT](#) [PAC6006.204NLT](#) [PH9407.204NLT](#) [PAC6006.264NLT](#) [PH9408.105NLT](#) [PH9408.494NLT](#) [PAC6006.104NLT](#)
[CM6350R-683-REEL](#) [CUW43T-513T-AU](#) [CUW43T-104T-AU](#)