



# Automotive Signal Common Mode Chokes

**ACMS-Q4523F**

Request Samples



Check Inventory



4.5 x 3.2 x 2.3 mm  
**RoHS/RoHS II Compliant**  
MSL Level = 1

## Features

- AEC-Q200 compliant, Grade 1
- PPAP ready and supported
- Manufactured in TS/IATF 16949 production lines
- Excellent impedance characteristics

## Applications

- Differential signal line common mode noise suppression.
- Multimedia devices
- Automotive applications such as ADAS, Infotainment, Sensing, TCU
- Automotive CANFD

## Electrical Specifications

Part Number	Inductance ( $\mu\text{H}$ ) (+50%/-30%)	DCR ( $\text{m}\Omega$ )	Rated Current (A)	Rated Voltage (Vdc)	Insulation Resistance ( $\text{M}\Omega$ )
		Max	Max	Max	Min
ACMS-Q4523F-101	100	2000	0.2	50	10

**Rated Current is based on an Irms temperature rise of 20°C**

**Inductance Test Conditions: 0.1MHz/0.1V**

**ACMS-Q4523F is AEC-Q200 Automotive certified**

**ACMS-Q4523F Series is RoHS Compliant and Pb free**

**Operating Temperature: -40°C to +150°C (Including self-heating)**

**Storage Temperature (on PCB): -40°C to +150°C**

**Storage (in original packaging): <40°C, <70% RH**



5101 Hidden Creek Ln, Spicewood TX 78669  
Phone: 512-371-6159 Fax: 512-351-8858  
For terms and conditions of sales, please visit:  
[www.abracon.com](http://www.abracon.com)

**REVISION Initial Release**  
**3/30/2022**

ABRACON IS  
ISO9001-2015  
CERTIFIED



# Automotive Signal Common Mode Chokes

ACMS-Q4523F

Request Samples



Check Inventory



4.5 x 3.2 x 2.3 mm  
RoHS/RoHS II Compliant  
MSL Level = 1

## Electrical Specifications

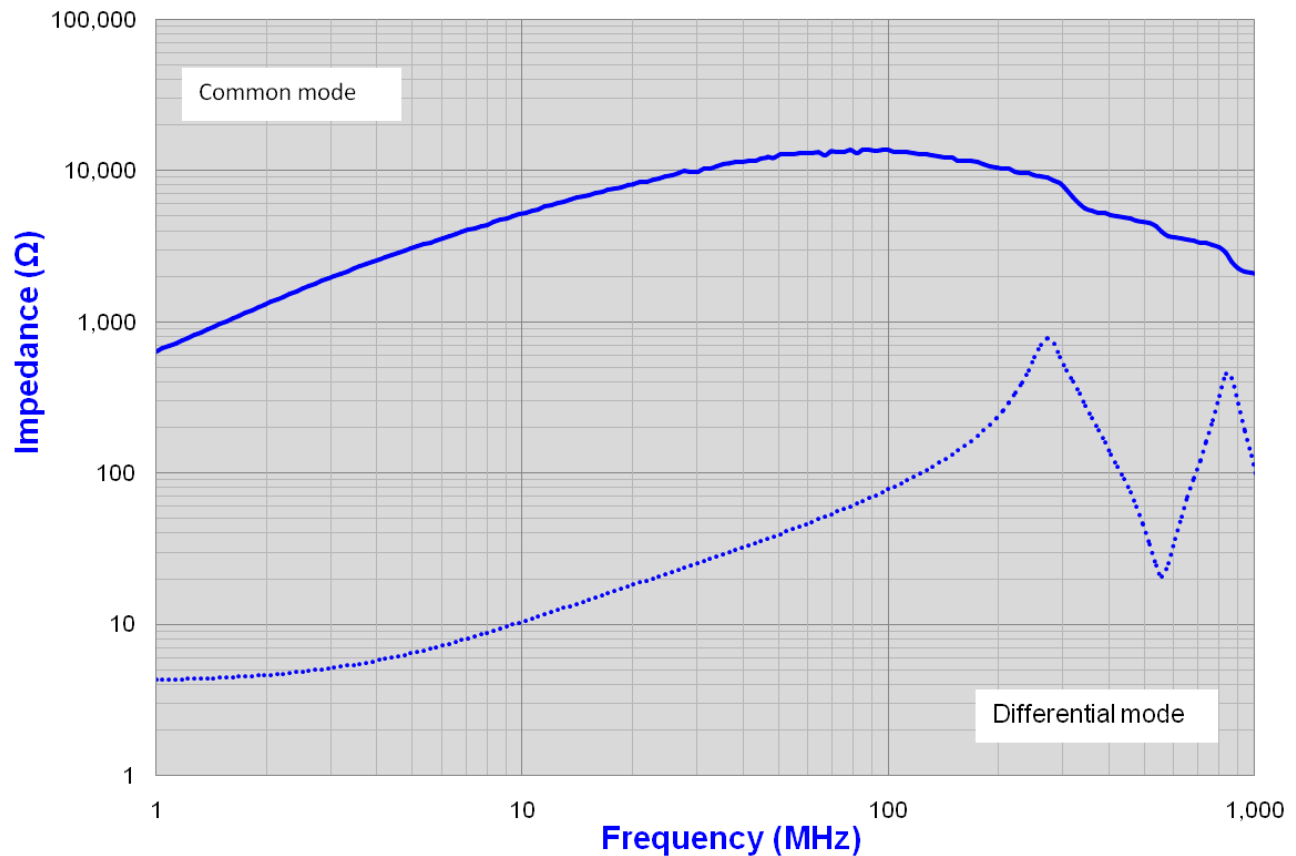

5101 Hidden Creek Ln, Spicewood TX 78669  
Phone: 512-371-6159 Fax: 512-351-8858  
For terms and conditions of sales, please visit:  
[www.abracon.com](http://www.abracon.com)

REVISION Initial Release  
3/30/2022

ABRACON IS  
ISO9001-2015  
CERTIFIED



# Automotive Signal Common Mode Chokes

ACMS-Q4523F

Request Samples



Check Inventory



4.5 x 3.2 x 2.3 mm  
**RoHS/RoHS II Compliant**  
 MSL Level = 1

## Mechanical Specifications

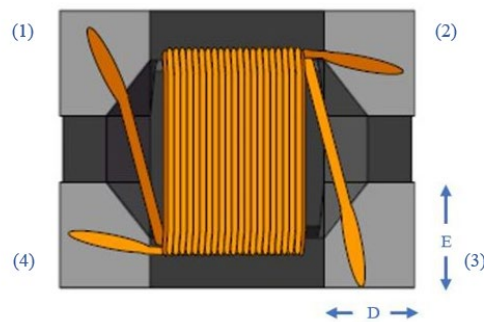
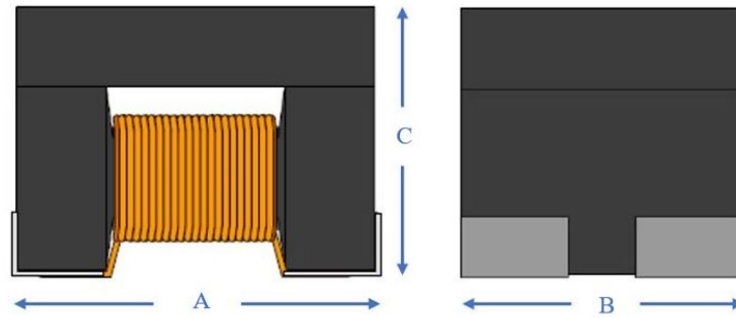

A	B	C	D	E
4.5 ±0.2	3.2 ±0.2	2.3 ±0.2	1.0 ±0.1	1.25 ±0.1

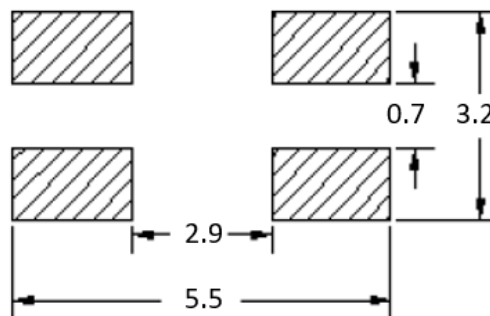

## Recommended Layout

Dimensions: mm



5101 Hidden Creek Ln, Spicewood TX 78669  
 Phone: 512-371-6159 Fax: 512-351-8858  
 For terms and conditions of sales, please visit:  
[www.abracon.com](http://www.abracon.com)

REVISION Initial Release  
 3/30/2022

ABRACON IS  
 ISO9001-2015  
 CERTIFIED



# Automotive Signal Common Mode Chokes

**ACMS-Q4523F**

Request Samples



Check Inventory



4.5 x 3.2 x 2.3 mm  
**RoHS/RoHS II Compliant**  
 MSL Level = 1

## Schematic

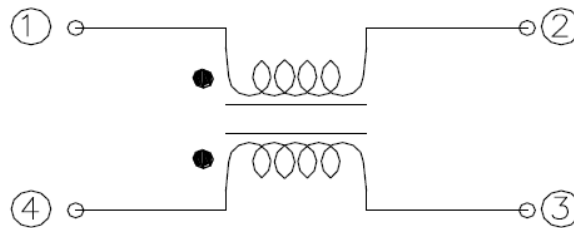

## Materials

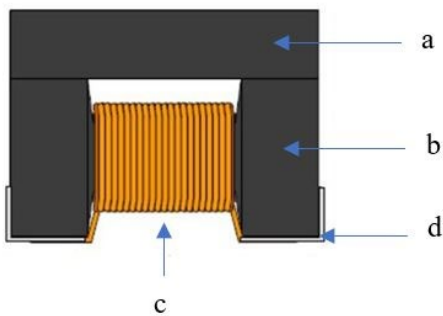

	Description	Specification
a	Upper Plate	Ni-Zn Ferrite
b	Core	Ni-Zn Ferrite
c	Wire	Enameled copper wire
d	Electrode	Ag/Ni/Sn

## Part Identification

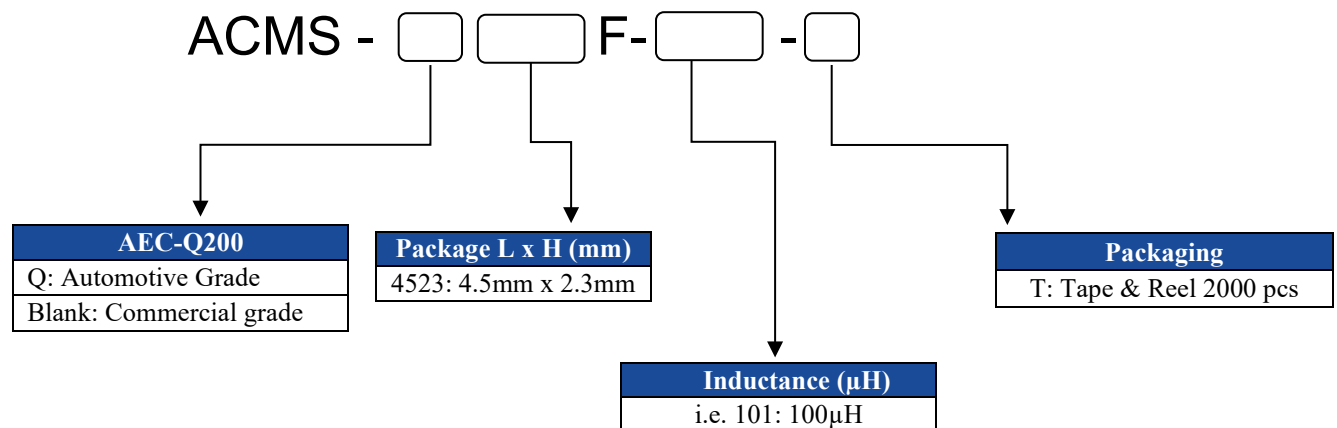



# Automotive Signal Common Mode Chokes

ACMS-Q4523F

Request Samples



Check Inventory



4.5 x 3.2 x 2.3 mm  
 RoHS/RoHS II Compliant  
 MSL Level = 1

## Reflow Profile

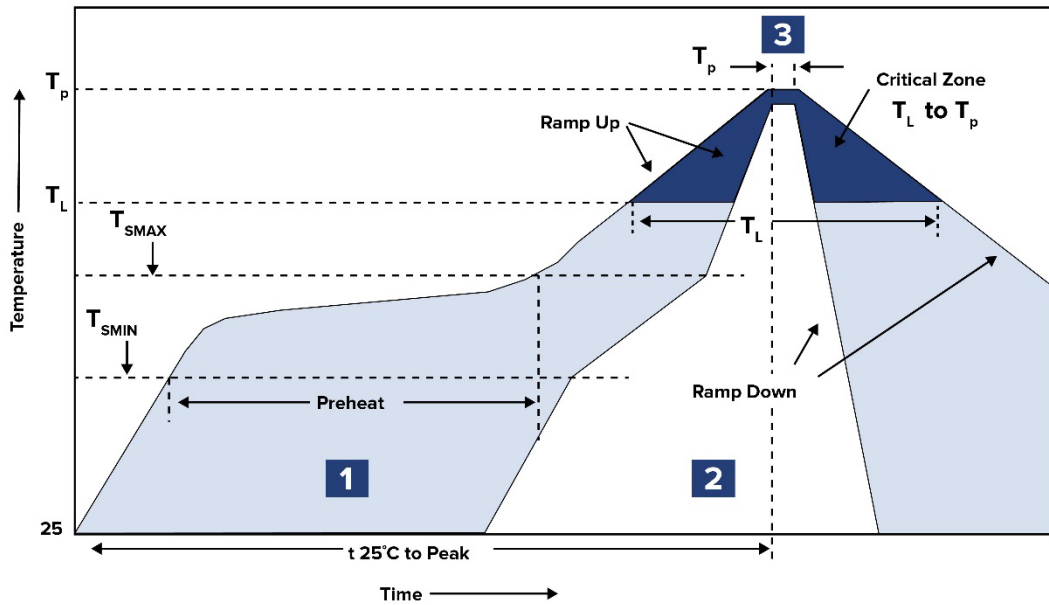

Zone	Description	Temperature	Times
1	Preheat	$T_{SMIN} \sim T_{SMAX}$ 150°C ~ 200°C	60 ~ 120 sec.
2	Reflow	$T_L$ 220°C	60 ~ 90 sec.
3	Peak heat	$T_p$ 260°C Max	10 sec. MAX



# Automotive Signal Common Mode Chokes

**ACMS-Q4523F**

Request Samples



Check Inventory



4.5 x 3.2 x 2.3 mm  
**RoHS/RoHS II Compliant**  
 MSL Level = 1

## Packaging

**Tape & Reel: 2000pcs/reel**

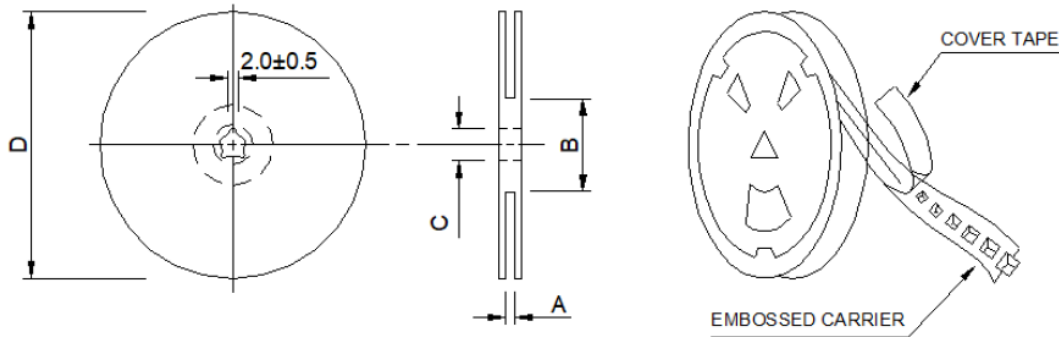

Series	A	B	C	D
ACMS-Q4523F	13.0 ±0.5	100.0 ±2.0	13.0 ±0.5	330

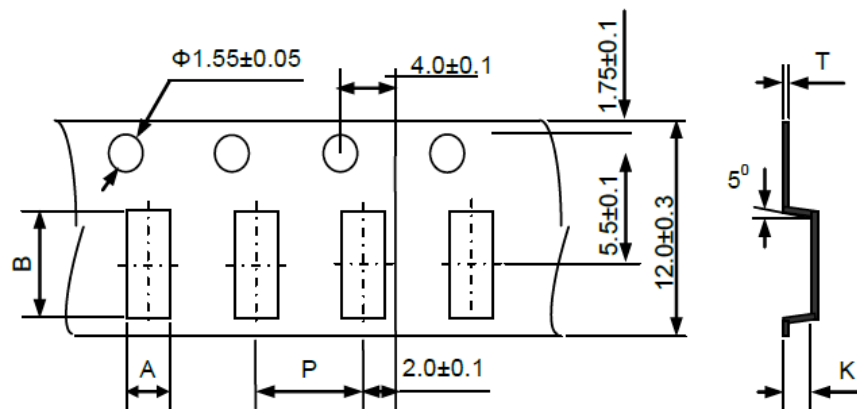

A	B	P	K	T
3.51 ±0.10	4.82 ±0.10	8.0 ±0.10	3.05 ±0.10	0.35 ±0.05

Dimensions: mm

**ATTENTION:** Abracon LLC's products are COTS – Commercial-Off-The-Shelf products; suitable for Commercial, Industrial and, where designated, Automotive Applications. Abracon's products are not specifically designed for Military, Aviation, Aerospace, Life-dependent Medical applications or any application requiring high reliability where component failure could result in loss of life and/or property. For applications requiring high reliability and/or presenting an extreme operating environment, written consent and authorization from Abracon LLC is required. Please contact Abracon LLC for more information.



5101 Hidden Creek Ln, Spicewood TX 78669  
 Phone: 512-371-6159 Fax: 512-351-8858  
 For terms and conditions of sales, please visit:  
[www.abracon.com](http://www.abracon.com)

**REVISION Initial Release**  
 3/30/2022

ABRACON IS  
 ISO9001-2015  
 CERTIFIED

## X-ON Electronics

Largest Supplier of Electrical and Electronic Components

*Click to view similar products for [Common Mode Chokes / Filters](#) category:*

*Click to view products by [Abracon](#) manufacturer:*

Other Similar products are found below :

[PE-64683](#) [RD5122-6-9M6](#) [ST6118T-R](#) [FE3X025-10-7NL](#) [T8114NLT](#) [TCM0806G-350-2P-T](#) [TCM0806G-650-2P-T](#) [IND-0110](#)  
[UAL21VR0802000](#) [UALSC023000000](#) [UALSC1020JH000](#) [UALSU10VD20010](#) [UALSU9VD070100](#) [36-00037](#) [CM7060M132R-10](#)  
[UALW21HS072450](#) [UALSU9H0208000](#) [UAL24VK06450CH](#) [PE-67531](#) [TLH10UB](#) [113 OR5](#) [2752045447](#) [CM8663Z161B-10](#) [7351V](#)  
[CMF16-153131](#) [T8116NLT](#) [CMS2-10-R](#) [FE2X10-4-2NL](#) [T8003NLT](#) [CTX01-13663](#) [CTX66-19521-R](#) [RC212-0.5-10M](#) [RC112-0.4-15M](#)  
[RC212-0.6-6M8](#) [RC212-0.4-15M](#) [RC112-0.3-30M](#) [4534-3](#) [WTCF2012Z0M751PB](#) [PH9408.814NLT](#) [B82498B3221J000](#) [PAC6006.364NLT](#)  
[PAC6006.444NLT](#) [PAC6006.204NLT](#) [PH9407.204NLT](#) [PAC6006.264NLT](#) [PH9408.105NLT](#) [PH9408.494NLT](#) [PAC6006.104NLT](#)  
[CM6350R-683-REEL](#) [CUW43T-513T-AU](#) [CUW43T-104T-AU](#)