

Surface Mount Ferrite Chip Beads

ACSB-03-T

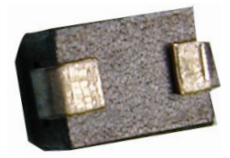

RoHS/RoHS II Compliant



4.00 x 3.10 x 2.60mm

FEATURES:

- Suitable for high density mounting or where board space is at a premium.
- Superior attenuation across a broad frequency range up to GHz range.
- Wide operating temperature range of -40°C to +85°C.
- RoHS Compliant and lead free.

APPLICATIONS:

- Notebooks, Tablets, Smartphones, Cameras, DVD/Blu-ray players, LED TVs, Motherboards, Power Supplies, Modems

STANDARD SPECIFICATIONS:

PARAMETERS

ABRACON P/N:	ACSB-03-T
Operating temperature:	-40°C to +85°C
Storage Temperature and Humidity (In Tape and Reel)	+5°C to +40°C, 60% to 70% RH

Key Electrical Specifications

Impedance	Test Frequency	Temperature Rise Current
Z (Ω)	MHz	IDC Max (A)
27 Min	25	5
47 ± 20%	100	

Test Conditions

Instrument: Agilent 4294A Precision Impedance Analyzer.

IDC: Based on temperature rise (ΔT : 40°C TYP.)

ELECTRICAL CHARACTERISTIC CURVE

Typical Impedance v.s. Frequency Curve

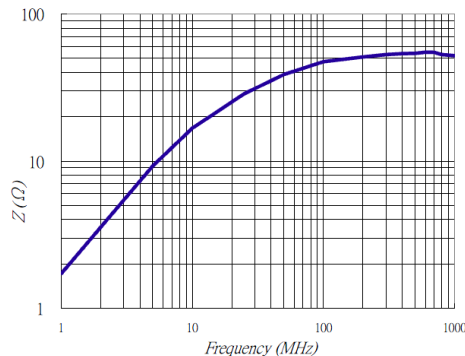

OUTLINE DIMENSIONS:

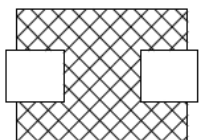
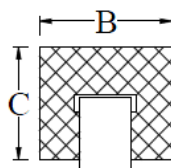
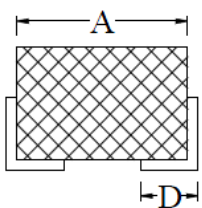

A	B	C	D
4.00±0.15	3.10±0.10	2.60±0.10	1.35±0.15

Recommended Land Pattern

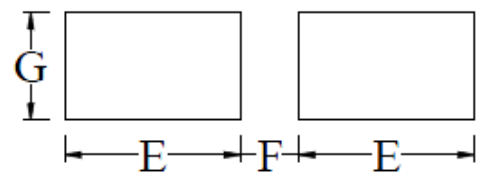

E	F	G
3.00 ref.	1.0 ref.	1.8 ref.

Dimension: mm

ABRACON IS
ISO 9001:2008
CERTIFIED



Visit www.abracon.com for Terms & Conditions of Sale
30332 Esperanza, Rancho Santa Margarita, California 92688
tel 949-546-8000 | fax 949-546-8001 | www.abracon.com

Revised: 09.20.13

Surface Mount Ferrite Chip Beads

ACSB-03-T



RoHS/RoHS II Compliant



4.00 x 3.10 x 2.60mm

REFLOW PROFILE:

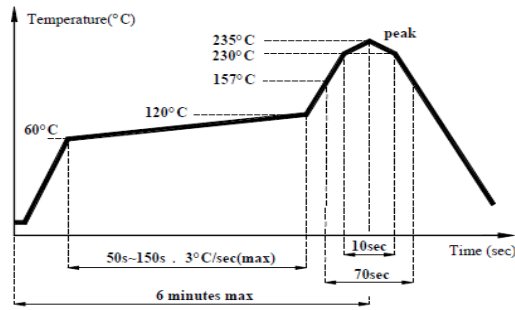

TAPE & REEL:

Packing
T: 500pcs / reel

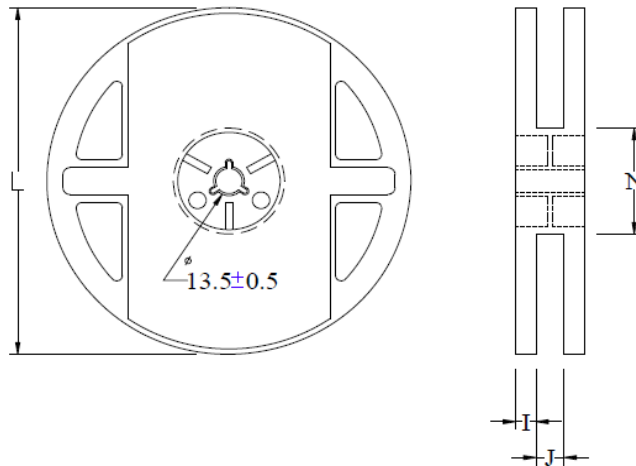
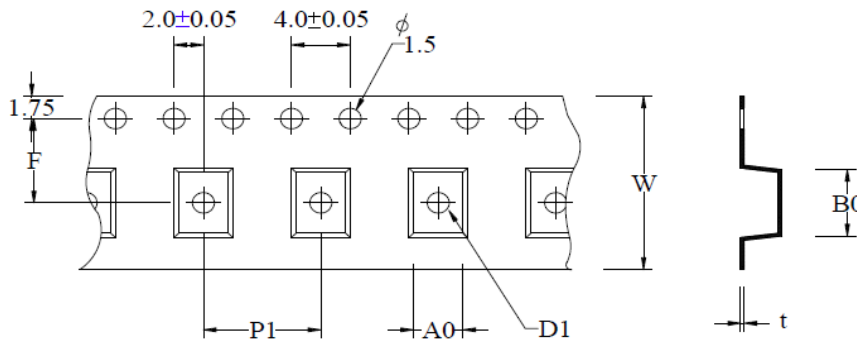

A0	B0	D1	F	P1	W	t	L	I	J	N
3.45 ± 0.1	4.90 ± 0.1	1.5	5.5	8	12	0.27	178	1.4	12	60

Dimension: mm

ATTENTION: Abracon Corporation's products are COTS – Commercial-Off-The-Shelf products; suitable for Commercial, Industrial and, where designated, Automotive Applications. Abracon's products are not specifically designed for Military, Aviation, Aerospace, Life-dependant Medical applications or any application requiring high reliability where component failure could result in loss of life and/or property. For applications requiring high reliability and/or presenting an extreme operating environment, written consent and authorization from Abracon Corporation is required. Please contact Abracon Corporation for more information.

ABRACON IS
ISO 9001:2008
CERTIFIED



Visit www.abracon.com for Terms & Conditions of Sale
30332 Esperanza, Rancho Santa Margarita, California 92688
tel 949-546-8000 | fax 949-546-8001 | www.abracon.com

Revised: 09.20.13

X-ON Electronics

Largest Supplier of Electrical and Electronic Components

Click to view similar products for [Ferrite Beads](#) category:

Click to view products by [ABRACON](#) manufacturer:

Other Similar products are found below :

[CZB1EGTTP700P](#) [CZB1JGTTD101P](#) [CZB1JGTTD151P](#) [CZB1JGTTD601P](#) [CZB2AFTTD800P](#) [CZB2AGTTD601P](#) [CZB2BFTTE600P](#) [PE-0402FB121ST](#) [EMI0805R-11](#) [NCB0603R301TR050F](#) [NCB0805A320TR050F](#) [NCB-H1206B680TR300F](#) [SMB2.5-1TR](#) [SMB2.5R-2](#) [2943778301](#) [CZB1EGTTP121P](#) [CZB1JGTTD102P](#) [CZB1JGTTD121P](#) [CZB1JGTTD221P](#) [CZB2AGTTD301P](#) [CZB2BFTTE601P](#) [4221R-1](#) [4221R-2](#) [4221R-3](#) [EMI0805R-2000](#) [EMI0805R-600](#) [SBY100505T-100Y-N](#) [NCB-GH0402D121TR060F](#) [NCB-H1812D125TR150F](#) [CZB2AGTTD102P](#) [NCB0402P301TR005F](#) [NCB0603R152TR030F](#) [NCB0805A121TR050F](#) [NCB3312K900TR500F](#) [NCB-H0805A221TR300F](#) [NCB-H1806E181TR300F](#) [NCB0402P300TR030F](#) [NCB0402P700TR050F](#) [NCB0805A102TR040F](#) [NCB1806E151TR020F](#) [NCB-H0603R121TR300F](#) [NCB-H0805A220TR600F](#) [NCB-H0805A390TR400F](#) [CIM21J252NE](#) [CZB2BFTTE121P](#) [EMI0805R-220](#) [74279250](#) [7427924](#) [CZB1JGTTD202P](#) [ABUPDE160808121Y00](#)