

SMD 2.45GHz Dielectric Band Pass Filter

ADFC15-2450.00-A-T

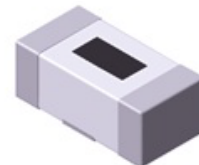

RoHS
Compliant



1.0 x 0.5 x 0.38mm

FEATURES:

- Small and low profile enables high density mounting
- Low insertion loss & attenuation
- Internally shielded for enhanced performance
- Excellent solderability

APPLICATIONS:

- Mobile communication system
- Bluetooth, Wireless LAN, WIFI, GPS, etc.

STANDARD SPECIFICATIONS:

Parameters	Minimum	Typical	Maximum	Units	Notes
Center Frequency (f_0)		2450.00		MHz	
Passband width	2400.00		2500.00	MHz	
Insertion Loss (2400 ~ 2500MHz)			1.4	dB	@+25°C
			1.7	dB	@ -40 ~ +85°C
Amplitude Ripple (2400 ~ 2500MHz)			0.5	dB	
V.S.W.R (2400 ~ 2500MHz)			1.5		
Relative Attenuation (Reference level: 0dB)	25			dB	800 ~ 960MHz
	8				1710 ~ 1970MHz
	23				4800 ~ 5000MHz
	32				7200 ~ 7500MHz
Characteristic Impedance		50		Ω	
Operation Temperature Range	-40		+85	°C	
Storage Temperature Range	-10		+40	°C	RH 70% Max

CHARACTERISTIC CURVE:

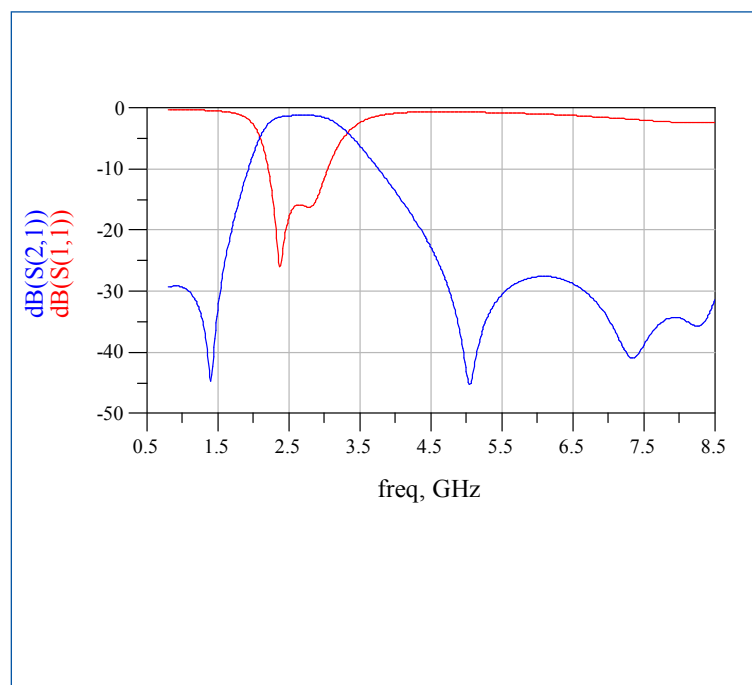

REFLOW PROFILE:

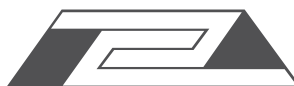
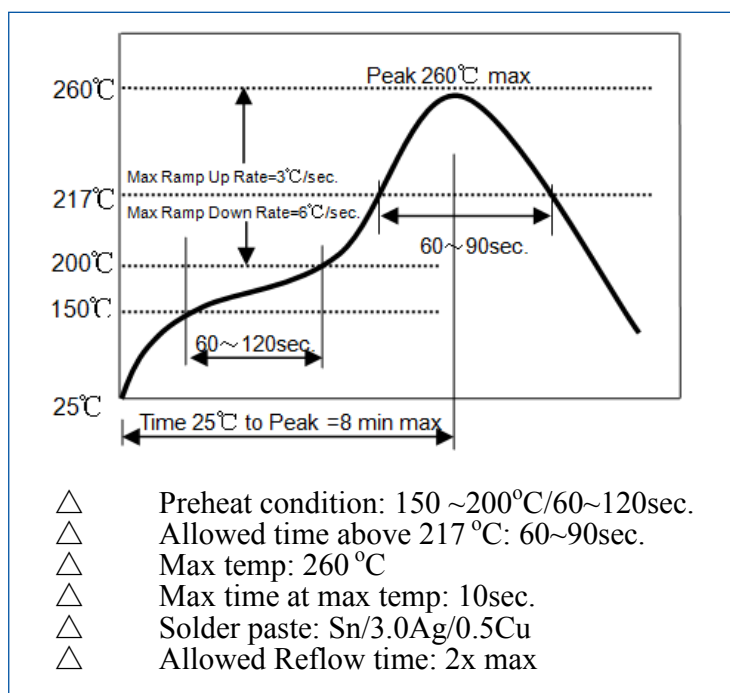

SMD 2.45GHz Dielectric Band Pass Filter

ADFC15-2450.00-A-T



RoHS
Compliant

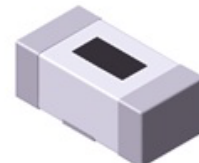

1.0 x 0.5 x 0.38mm

OUTLINE DRAWING:

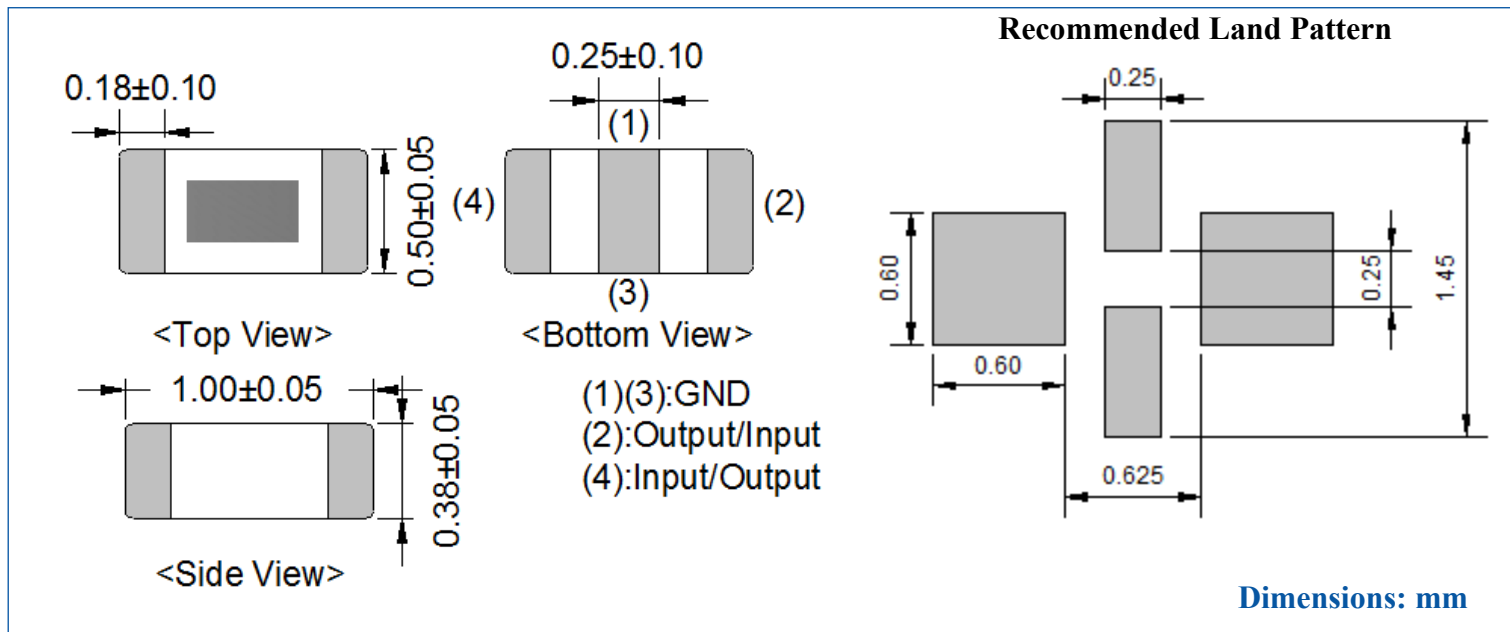

TAPE & REEL:

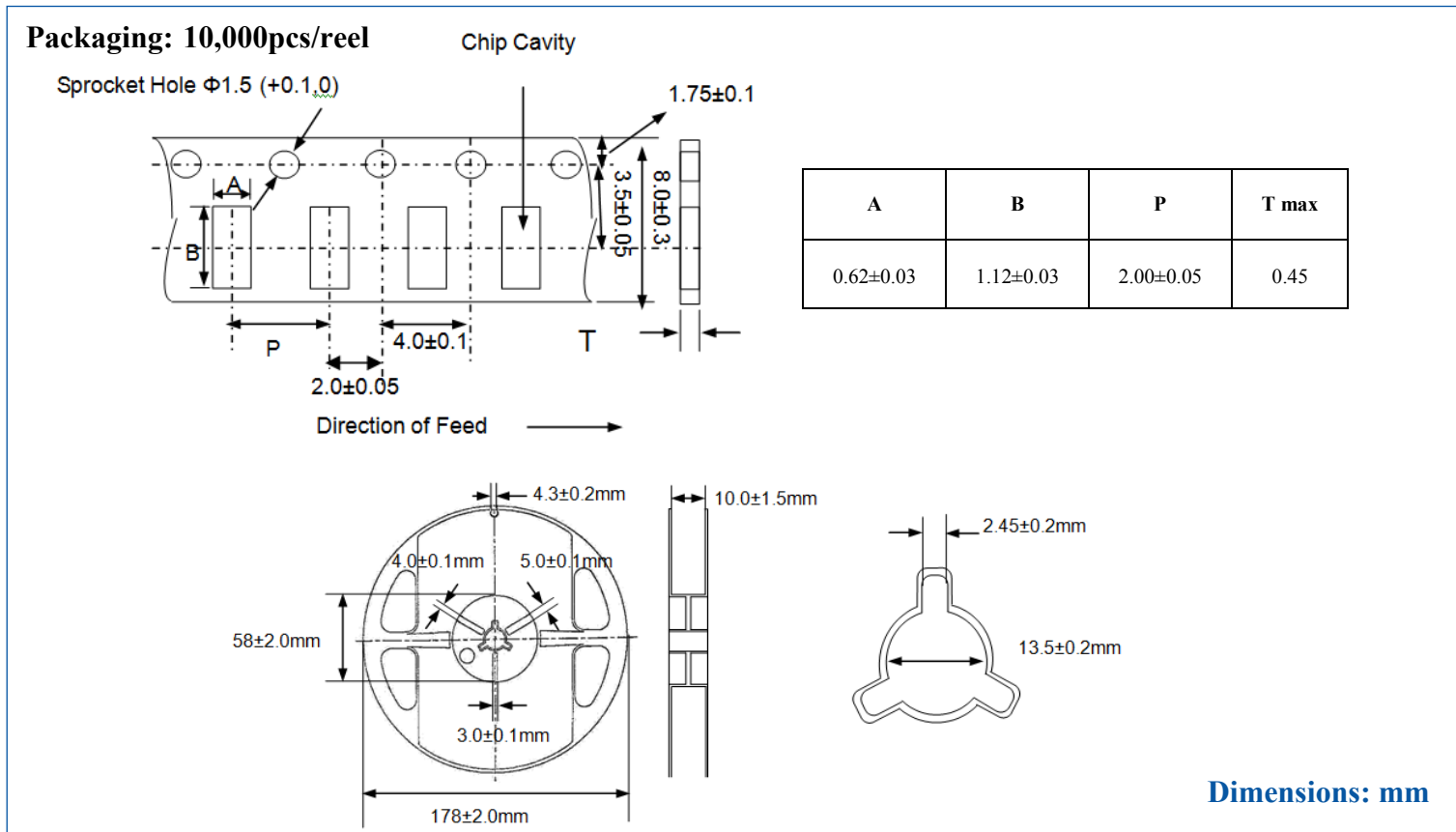

ATTENTION: Abracon Corporation's products are COTS – Commercial-Off-The-Shelf products; suitable for Commercial, Industrial and, where designated, Automotive Applications. Abracon's products are not specifically designed for Military, Aviation, Aerospace, Life-dependant Medical applications or any application requiring high reliability where component failure could result in loss of life and/or property. For applications requiring high reliability and/or presenting an extreme operating environment, written consent and authorization from Abracon Corporation is required. Please contact Abracon Corporation for more information.

ABRACON IS
ISO 9001:2008
CERTIFIED



ABRACON
CORPORATION

Visit www.abracon.com for Terms & Conditions of Sale
30332 Esperanza, Rancho Santa Margarita, California 92688
tel 949-546-8000 | fax 949-546-8001 | www.abracon.com

Revised: 12.03.12

X-ON Electronics

Largest Supplier of Electrical and Electronic Components

Click to view similar products for [Signal Conditioning](#) category:

Click to view products by [ABRACON](#) manufacturer:

Other Similar products are found below :

[MAPDCC0001](#) [MAPDCC0004](#) [PD0409J5050S2HF](#) [880157](#) [HHS-109-PIN](#) [DC1417J5005AHF](#) [AFS14A30-2185.00-T3](#) [AFS14A35-1591.50-T3](#) [DS-323-PIN](#) [B39321R801H210](#) [1A0220-3](#) [JP510S](#) [LFB212G45SG8C341](#) [LFB322G45SN1A504](#) [LFL182G45TC3B746](#) [SF2159E](#) [30057](#) [FM-104-PIN](#) [CER0813B](#) [MAPDCC0005](#) [3A325](#) [40287](#) [41180](#) [ATB3225-75032NCT](#) [BD0810N50100AHF](#) [BD2425J50200AHF](#) [C5060J5003AHF](#) [JHS-115-PIN](#) [JP503AS](#) [DC0710J5005AHF](#) [DC2327J5005AHF](#) [DC3338J5005AHF](#) [43020](#) [LFB2H2G60BB1C106](#) [LFL15869MTC1B787](#) [X3C19F1-20S](#) [XC3500P-20S](#) [10013-20](#) [SF2194E](#) [CDBLB455KCAX39-B0](#) [TGL2208-SM, EVAL](#) [RF1353C](#) [1E1305-3](#) [1F1304-3S](#) [1G1304-30](#) [B0922J7575AHF](#) [2020-6622-20](#) [TP-102-PIN](#) [TP-103-PIN](#) [BD1222J50200AHF](#)