

4G/LTE External Antenna



AEACAC198013-S698



198.0 x Ø13.0 mm
RoHS/RoHS II Compliant

MSL = N/A: NOT APPLICABLE

FEATURES

- Operates in 698-960 MHz and 1710-2655 MHz
- Gain of 3dBi
- VSWR \leq 3.0
- Input of 10W

APPLICATIONS

- 4G/LTE
- 2G/3G/4G radios
- LTE radios
- Gateways
- Set-Top Boxes
- Security
- IoT

ELECTRICAL SPECIFICATIONS

Parameters	min	Typ.	Max.	Units	Note
Frequency Range		698~960/1710~2655		MHz	
VSWR			3.0		
Polarization Model		Linear			
Impedance		50		Ω	
Gain		3		dBi	
Operating Temperature	-40		+85	$^{\circ}\text{C}$	
Input Power			10	W	

RETURN - LOSS CHARACTERISTICS

S11 Return-Loss

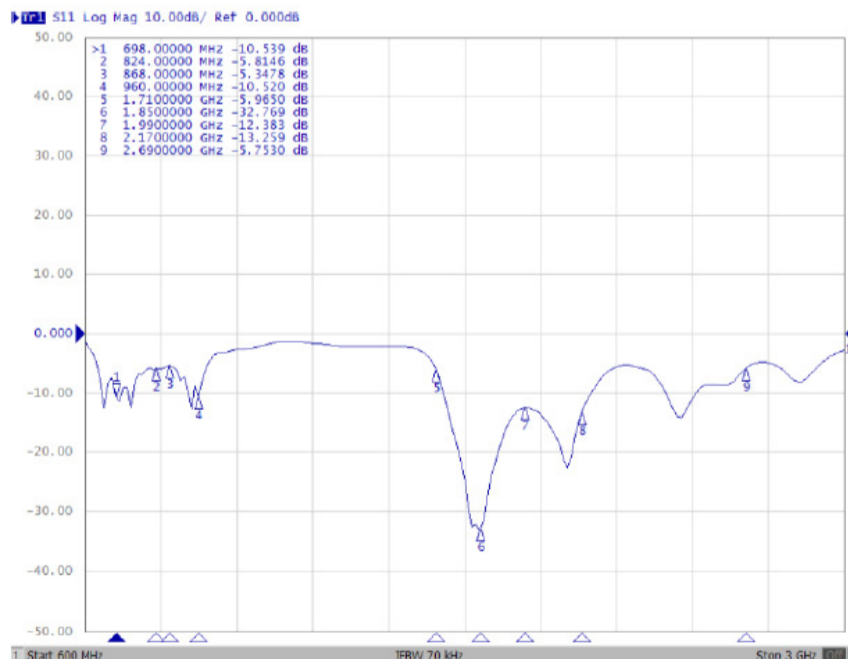

5101 Hidden Creek Ln Spicewood TX 78669
Phone: 512-371-6159 | Fax: 512-351-8858
For terms and conditions of sales, please visit:
www.abracon.com

REVISED: 04.10.2020

ABRACON IS
ISO9001-2015
CERTIFIED

4G/LTE External Antenna

AEACAC198013-S698



198.0 x Ø13.0 mm
RoHS/RoHS II Compliant

MSL = N/A: NOT APPLICABLE

RADIATION PATTERNS

Antenna 2D Patterns

XY Plane

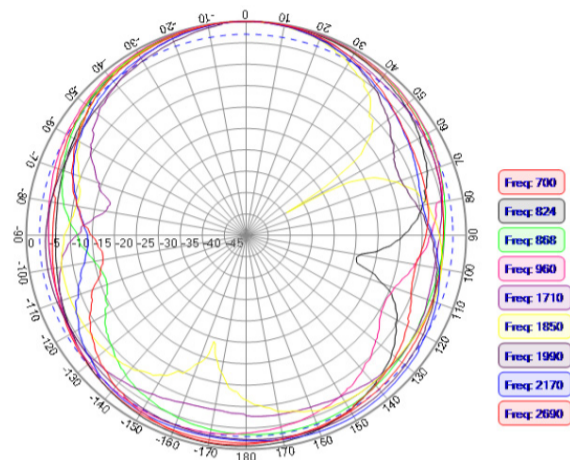

XZ Plane

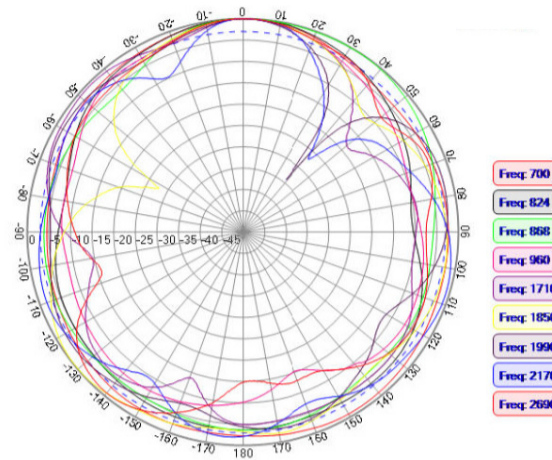

YZ Plane

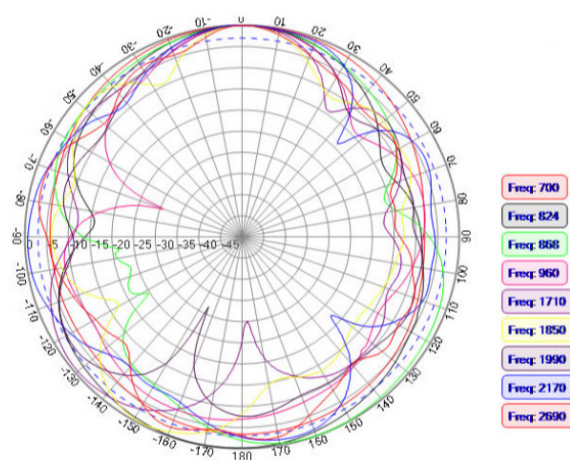

Antenna 3D Patterns 700 MHz

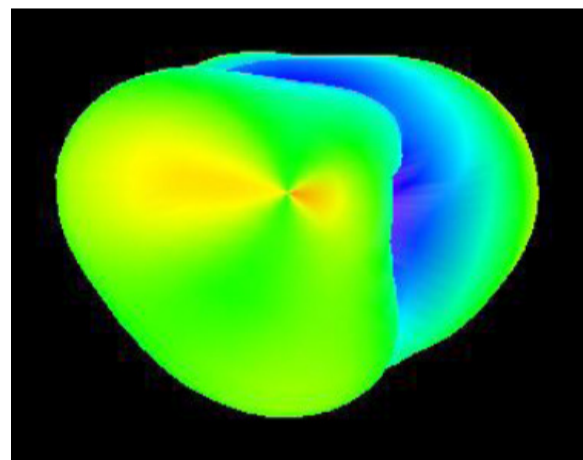

824 MHz

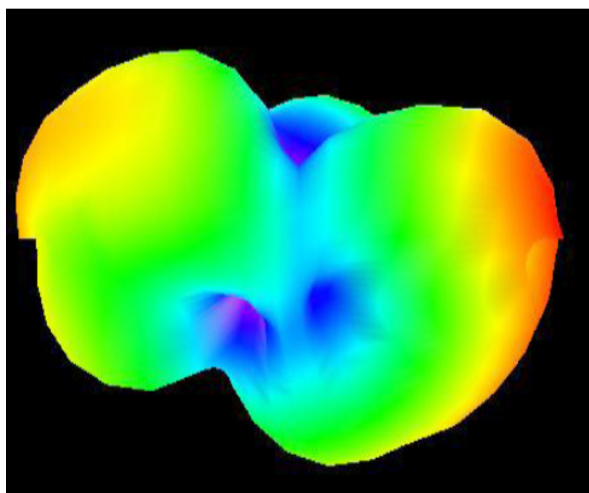

868 MHz

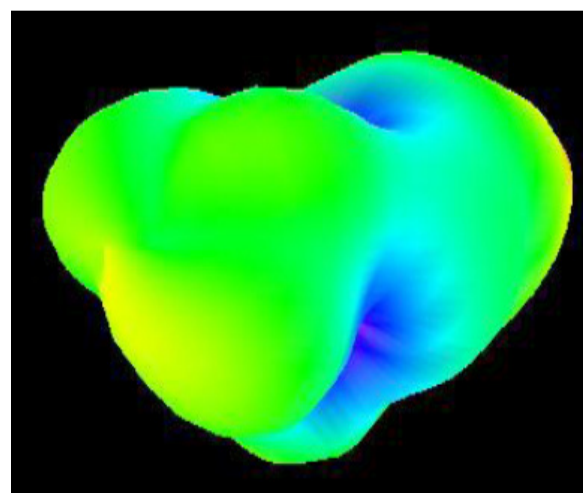

4G/LTE External Antenna



AEACAC198013-S698

Pb | 198.0 x Ø13.0 mm
RoHS/RoHS II Compliant
 MSL = N/A: NOT APPLICABLE

RADIATION PATTERNS

960 MHz

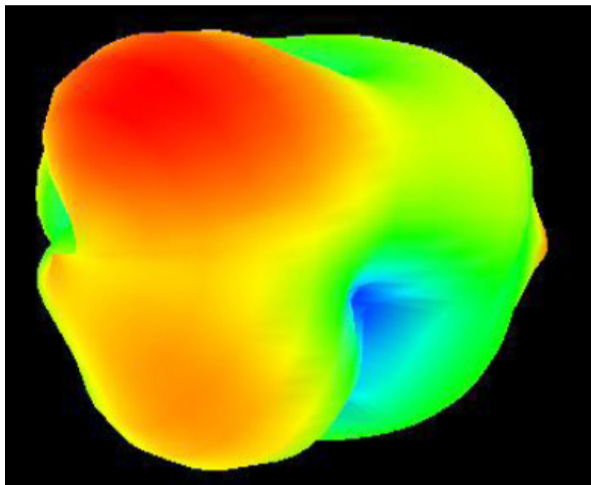

1710 MHz

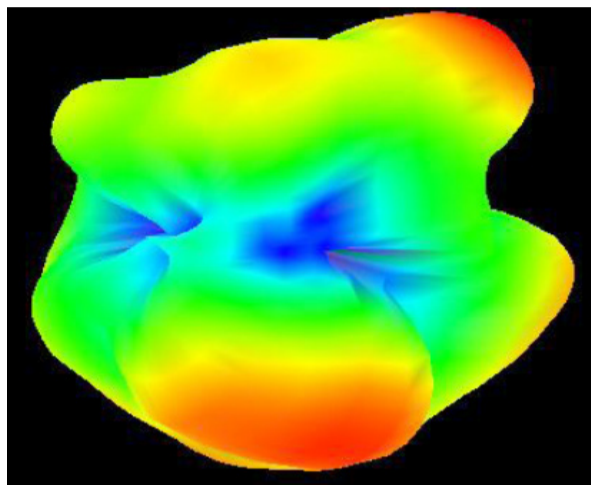

1850 MHz

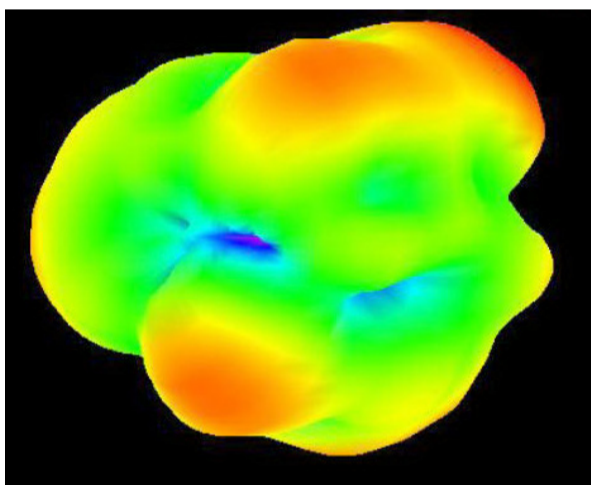

1990 MHz

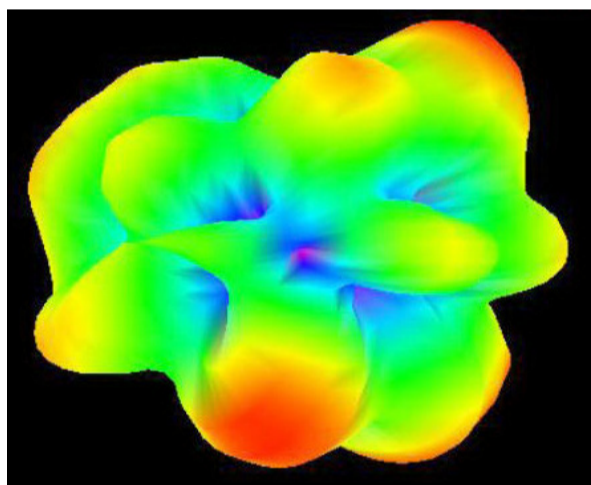

2170 MHz

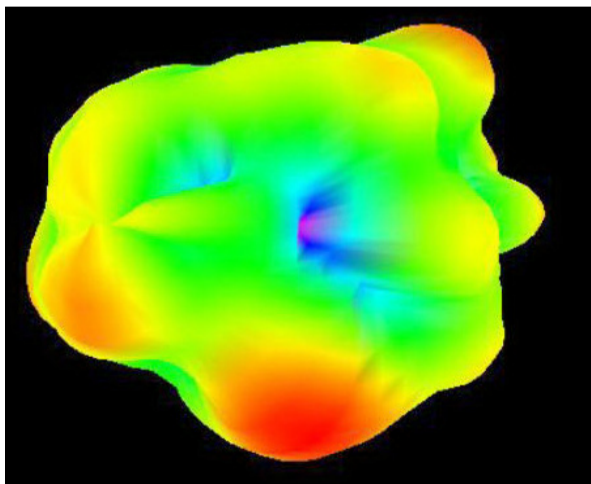

2690 MHz

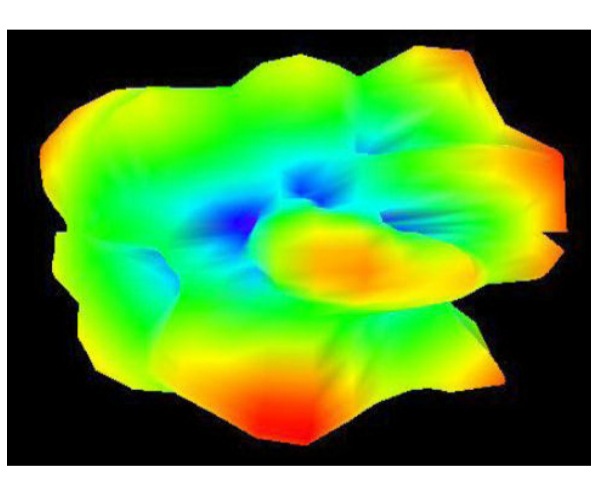

Frequency (MHz)	700	824	868	960	1710	1850	1990	2170	2690
Peak Gain (dBi)	3.50	3.60	4.60	3.30	-0.40	3.20	2.00	1.69	0.52
Efficiency (%)	55	58	57	56	57	60	63	60	58



5101 Hidden Creek Ln Spicewood TX 78669
 Phone: 512-371-6159 | Fax: 512-351-8858
 For terms and conditions of sales, please visit:
www.abracon.com

REVISED: 04.10.2020

ABRACON IS
 ISO9001-2015
 CERTIFIED

4G/LTE External Antenna

AEACAC198013-S698



198.0 x Ø13.0 mm
RoHS/RoHS II Compliant

Pb MSL = N/A: NOT APPLICABLE

DIMENSIONS:

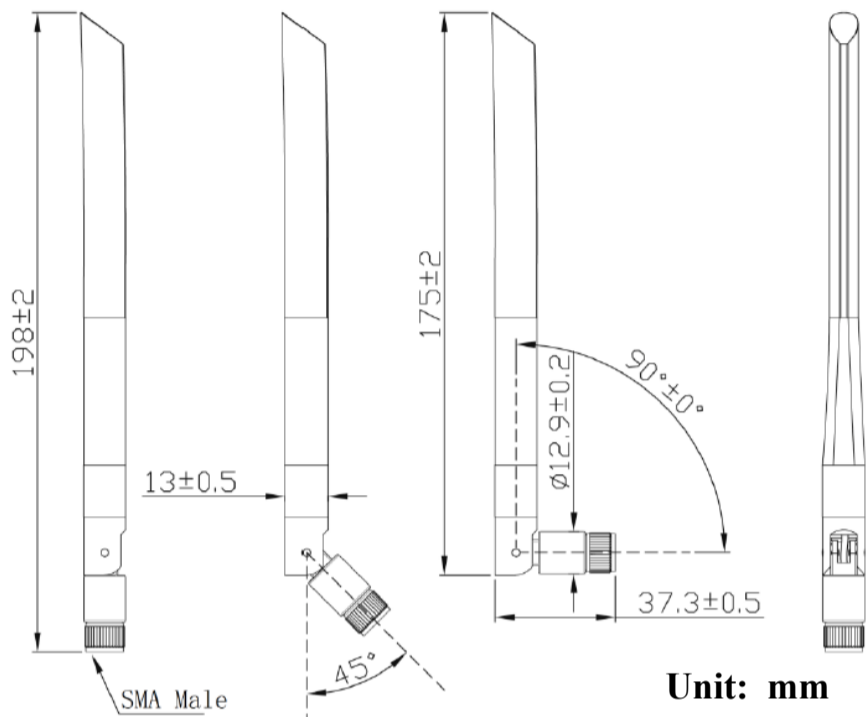

Parameters	Description
RF Connector	SMA Male
Mounting Type	Connector mount

PACKAGING:

Each 495 x 225 x 270 mm size carton includes 500 pcs antenna, 13kgs/carton.

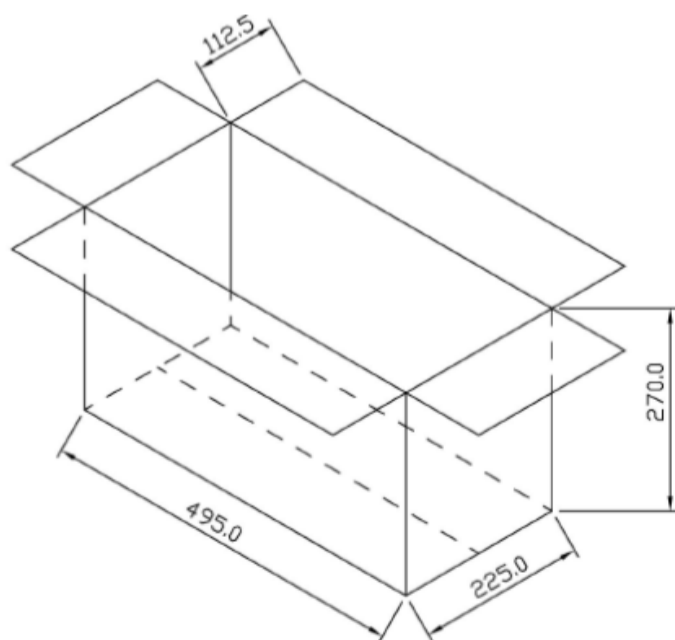

Unit: mm

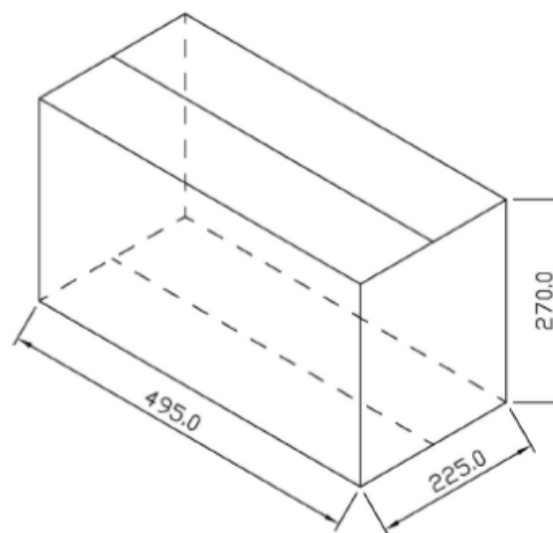

X-ON Electronics

Largest Supplier of Electrical and Electronic Components

Click to view similar products for [Antennas](#) category:

Click to view products by [ABRACON](#) manufacturer:

Other Similar products are found below :

[GAN30084EU](#) [930-033-R](#) [GW17.07.0250E](#) [1513563-1](#) [EXE902SM](#) [APAMPG-117](#) [MAF94383](#) [W3908B0100](#) [W6102B0100](#) [YE572113-30RSMM](#) [108-00014-50](#) [66089-2406](#) [A09-F8NF-M](#) [A09-F5NF-M](#) [RGFRA1903041A1T](#) [W3593B0100](#) [W3921B0100](#) [SIMNA-868](#) [SIMNA-915](#) [SIMNA-433](#) [W1044](#) [W1049B090](#) [A75-001](#) [WTL2449CQ1-FRSMM](#) [CPL9C](#) [EXB148BN](#) [0600-00060](#) [TRA9020S3PBN-001](#) [GD5W-28P-NF](#) [MA9-7N](#) [GD53-25](#) [GD5W-21P-NF](#) [EXB144SM](#) [C37](#) [MAF94051](#) [GD35-17P-NF](#) [P1744](#) [MA9-5N](#) [EXD420PL](#) [B1322NR](#) [QWFTB120](#) [MAF94271](#) [MAF94300](#) [GPSMB301](#) [FG4403](#) [AO-AGSM-OM54](#) [5200232](#) [MIKROE-2349](#) [WCM.01.0111](#) [MIKROE-2393](#)