

# 2x2 4G/LTE MIMO Antenna

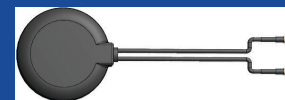

AEACBA081014-M698



Ø81.6 x 14.5 mm  
RoHS/RoHS II Compliant

MSL - N/A

## FEATURES

- Covers 4G/LTE
- Operates in 698-2700 MHz
- IP67 rated
- Linear polarization
- Gain of 3.0 dBi
- Adhesive mounting

## APPLICATIONS

- 4G/LTE
- Telematics
- Fleet monitoring
- IoT
- Video, Surveillance
- Femtocells
- M2M

## Electrical Specifications

Parameters	Min	Typ.	Max.	Units	Note
Frequency Range		698-960/1710-2690		MHz	
VSWR			3.0		
Polarization Model	Linear				
Impedance		50		Ω	
Gain Main		3		dBi	Zenith
Gain AUX		3		dBi	Zenith

## Mechanical Characteristics

Parameters	Description
Connector	2xSMA Male
Cable Type	2xRG174
Cable Length	2x2M
Material	ABS
Mount way	Adhesive
Dimensions	Φ81.6x14.5mm

# 2x2 4G/LTE MIMO Antenna



AEACBA081014-M698



Ø81.6 x 14.5 mm  
RoHS/RoHS II Compliant

MSL - N/A

## Environmental Characteristics

Parameters	Description
Waterproof	IP67
Operating Temperature	-40 ~ +85 °C
Relative Humidity	Up to 95%
MSL Level	N/A
ROHS Compliant	Yes
Vibration	10 to 55Hz with 1.5mm amplitude 2 hours

## Dimensions

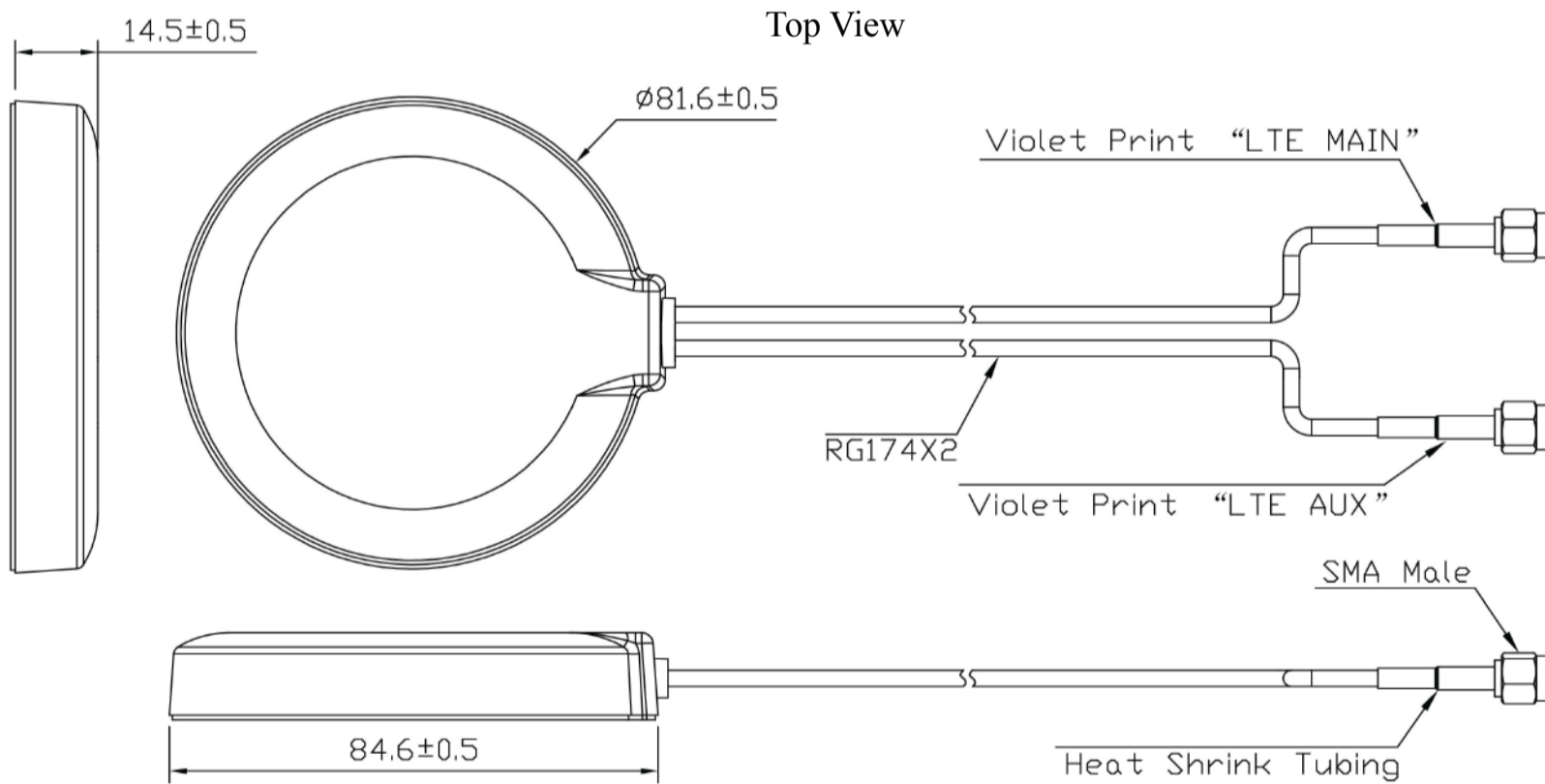

Unit:mm

# 2x2 4G/LTE MIMO Antenna



AEACBA081014-M698



Ø81.6 x 14.5 mm  
RoHS/RoHS II Compliant

MSL - N/A

## Product Image

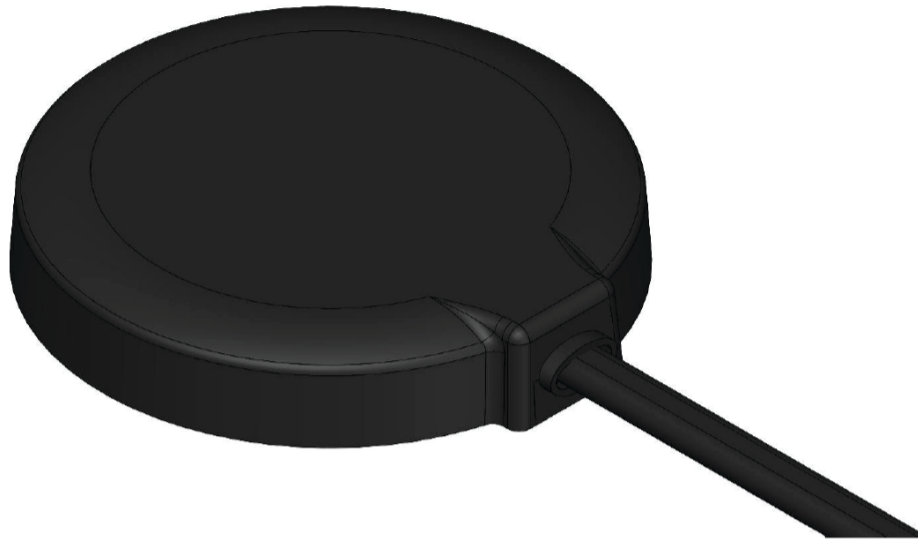

## VSWR Characteristics

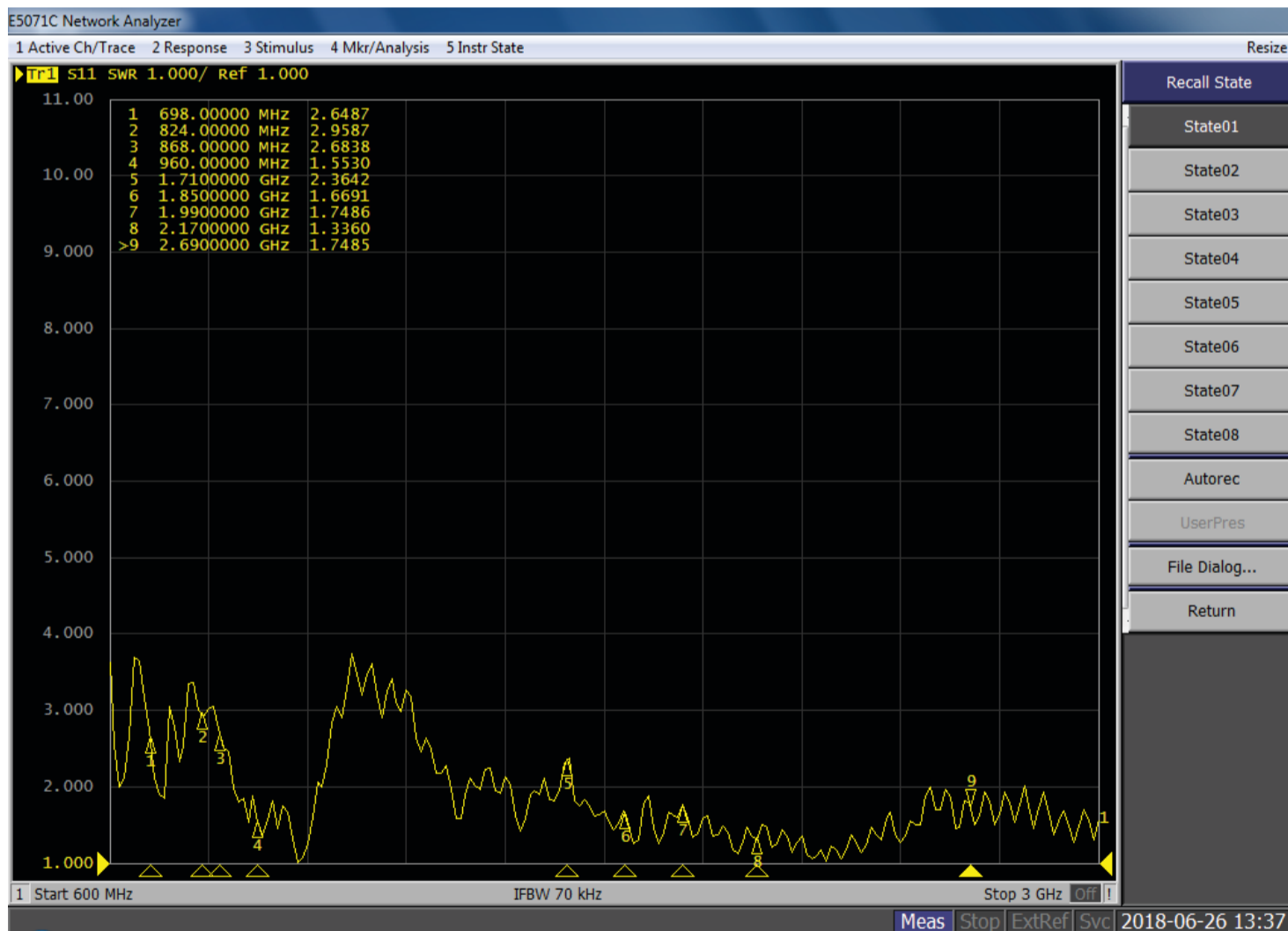

# 2x2 4G/LTE MIMO Antenna

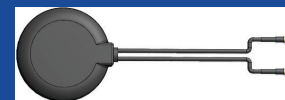

AEACBA081014-M698



Ø81.6 x 14.5 mm  
RoHS/RoHS II Compliant

MSL - N/A

## Gain and Efficiency

Frequency (MHz)	Efficiency	Gain (dBi)
700	0.62	2.23
824	0.68	3.0
868	0.62	1.12
960	0.66	1.0
1710	0.61	0.9
1850	0.65	0.3
1990	0.63	0.73
2170	0.64	1.96
2690	0.65	1.94

## Radiation Patterns



# 2x2 4G/LTE MIMO Antenna



AEACBA081014-M698



Ø81.6 x 14.5 mm  
RoHS/RoHS II Compliant

MSL - N/A

## Radiation Patterns

2D Radiation Patterns  
LTE Antenna MAIN

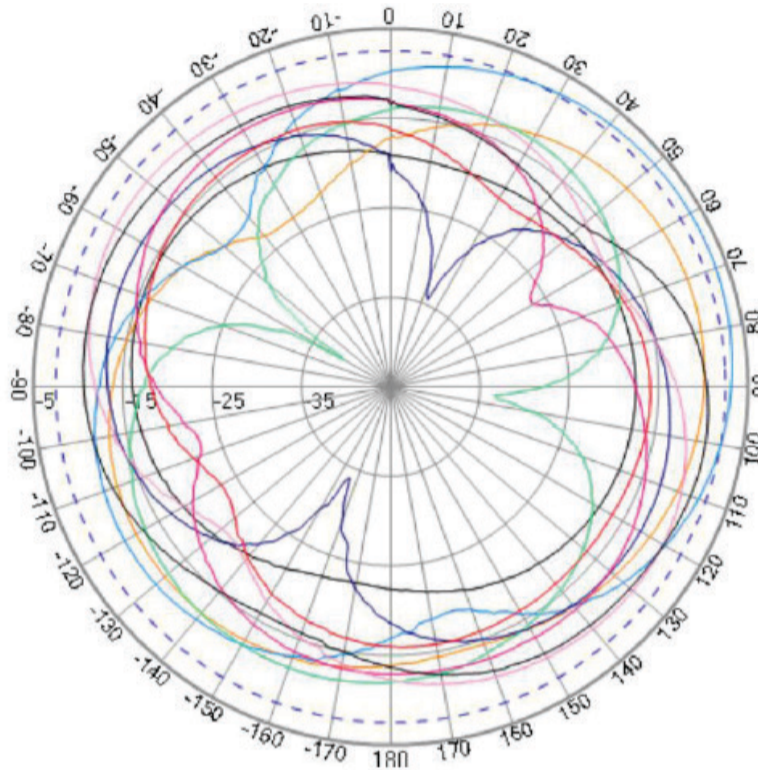

XY PLANE

- Freq: 700
- Freq: 824
- Freq: 868
- Freq: 960
- Freq: 1710
- Freq: 1850
- Freq: 1990
- Freq: 2170
- Freq: 2690

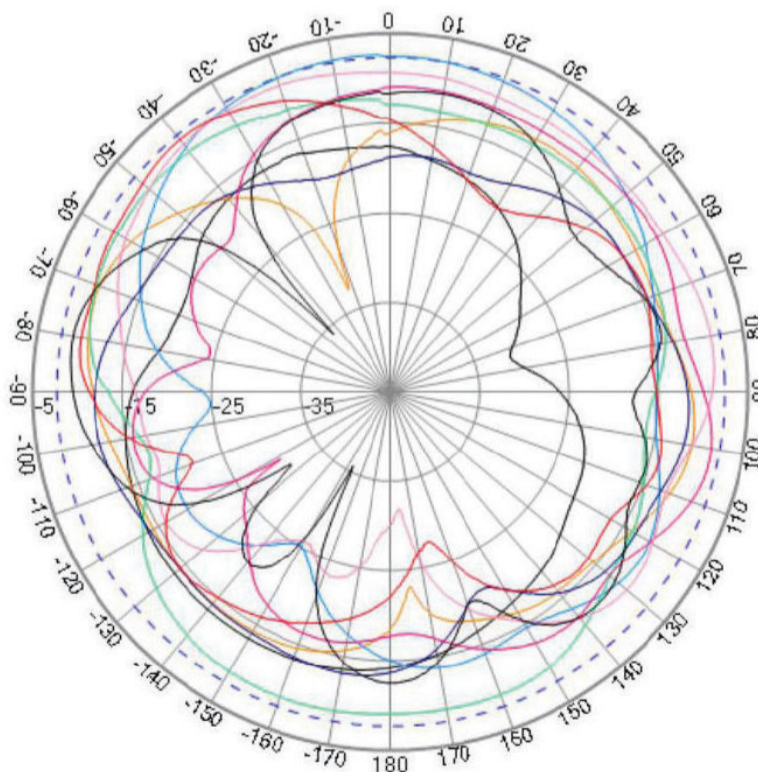

XZ PLANE

- Freq: 700
- Freq: 824
- Freq: 868
- Freq: 960
- Freq: 1710
- Freq: 1850
- Freq: 1990
- Freq: 2170
- Freq: 2690



5101 Hidden Creek Ln Spicewood TX 78669  
Phone: 512-371-6159 | Fax: 512-351-8858  
For terms and conditions of sales, please visit:  
[www.abracon.com](http://www.abracon.com)

REVISED: 08.15.2018

ABRACON IS  
ISO9001-2015  
CERTIFIED

# 2x2 4G/LTE MIMO Antenna



AEACBA081014-M698



Ø81.6 x 14.5 mm  
RoHS/RoHS II Compliant

MSL - N/A

## Radiation Patterns

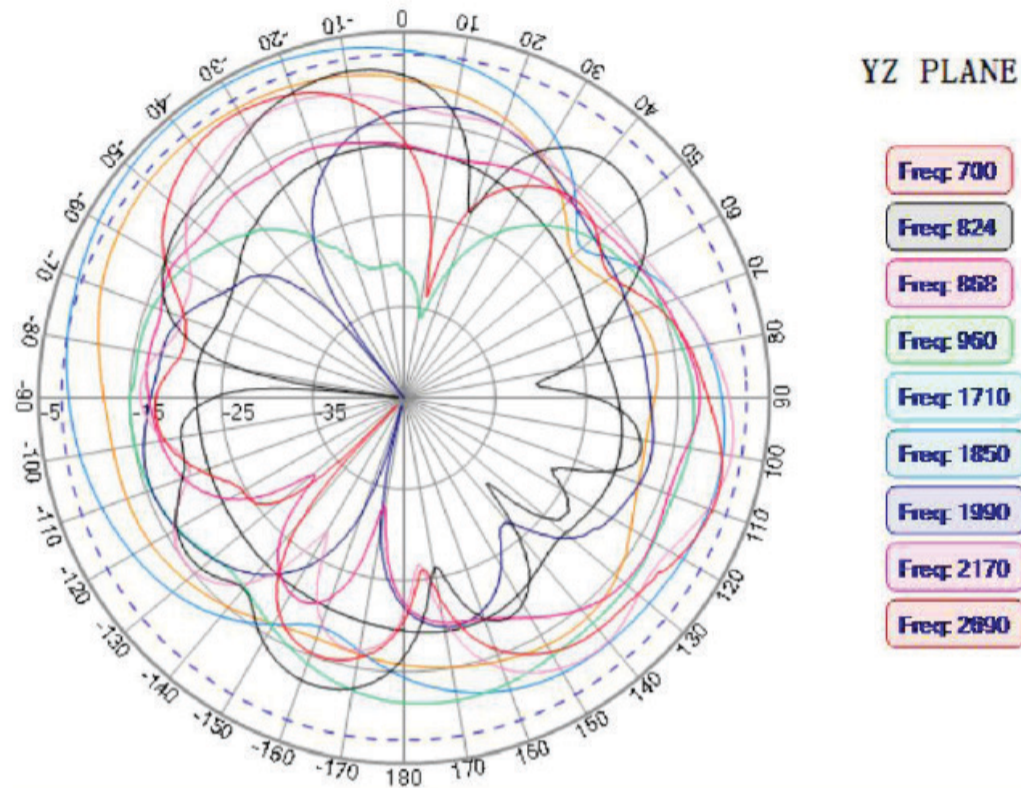

## LTE Antenna AUX

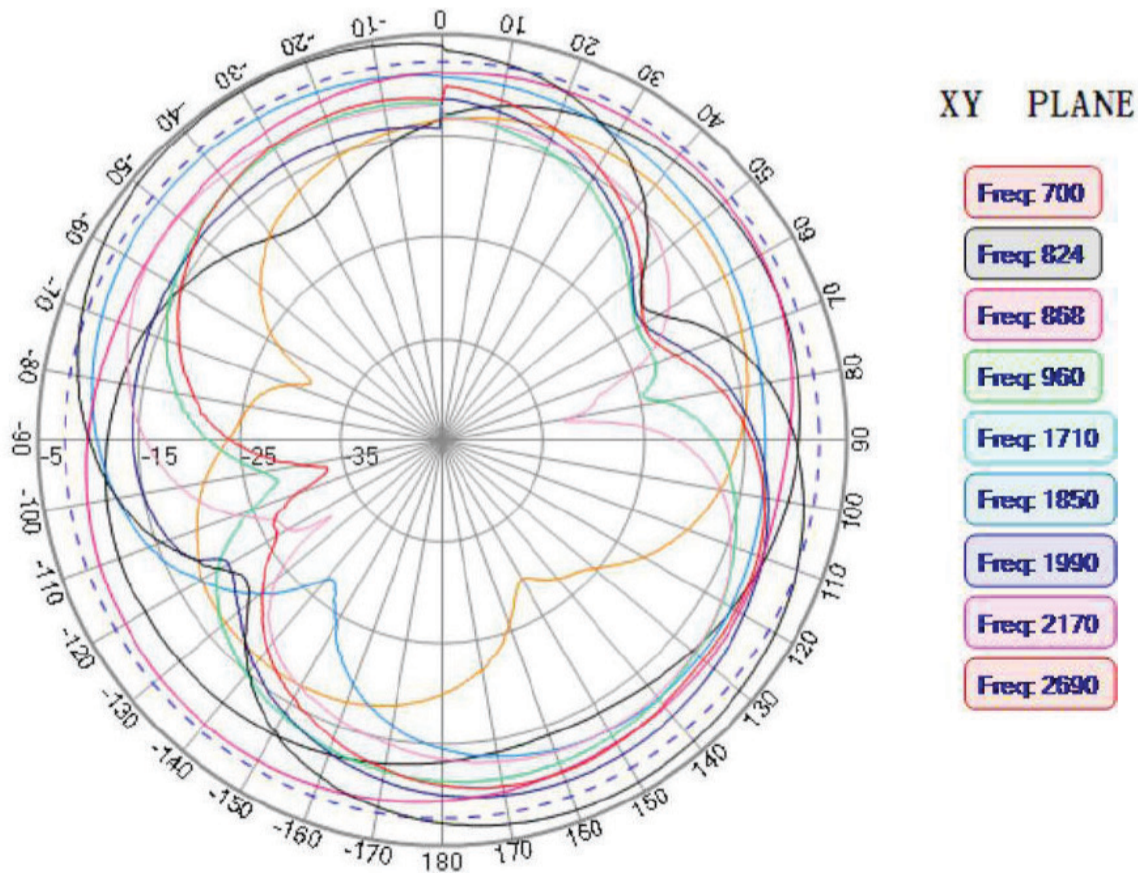

# 2x2 4G/LTE MIMO Antenna



AEACBA081014-M698



Ø81.6 x 14.5 mm  
RoHS/RoHS II Compliant

MSL - N/A

## Radiation Patterns

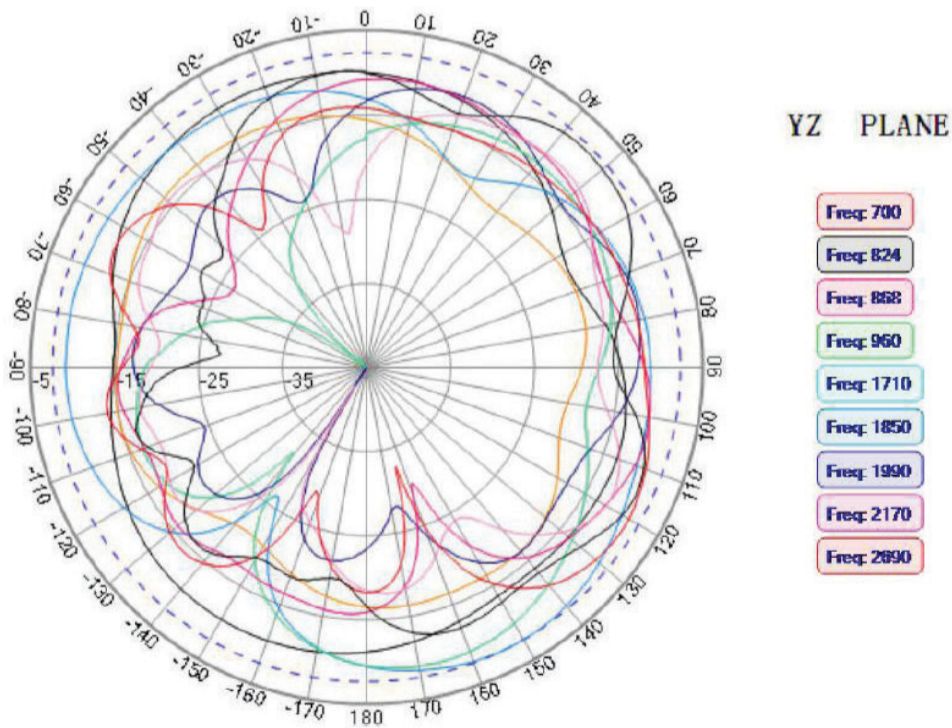
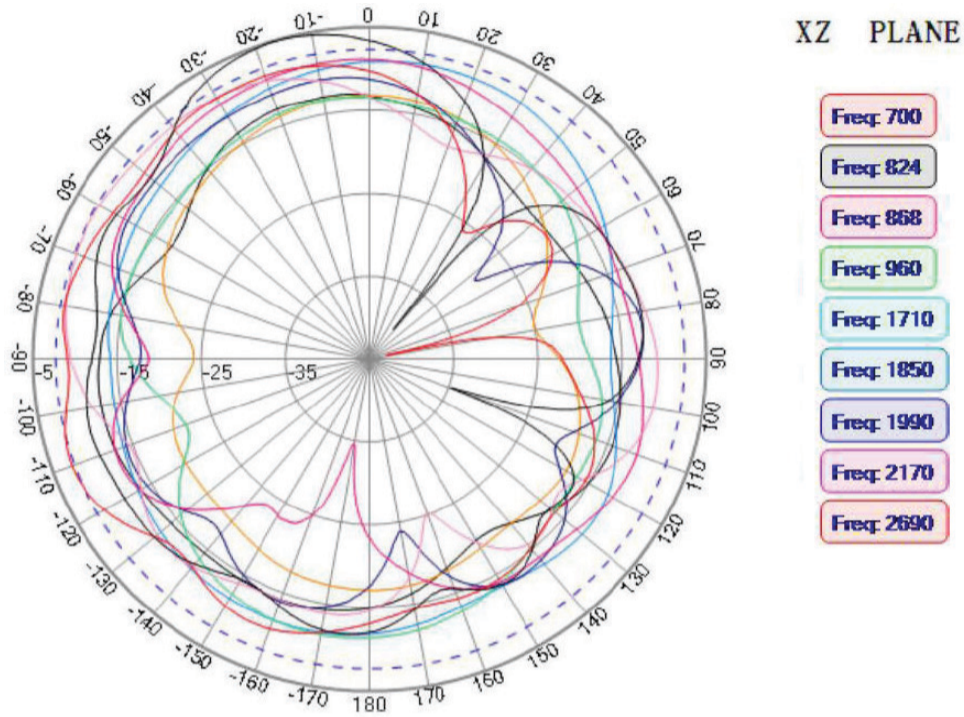

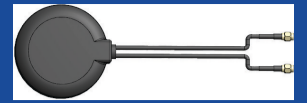

AEACBA081014-M698



Ø81.6 x 14.5 mm  
RoHS/RoHS II Compliant

MSL - N/A

**3D Radiation Patterns**

---

700 MHz

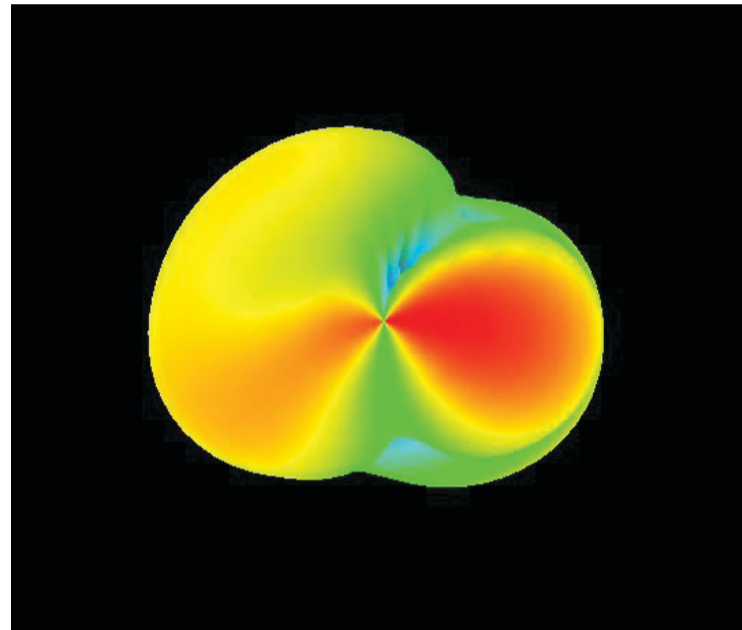

824 MHz

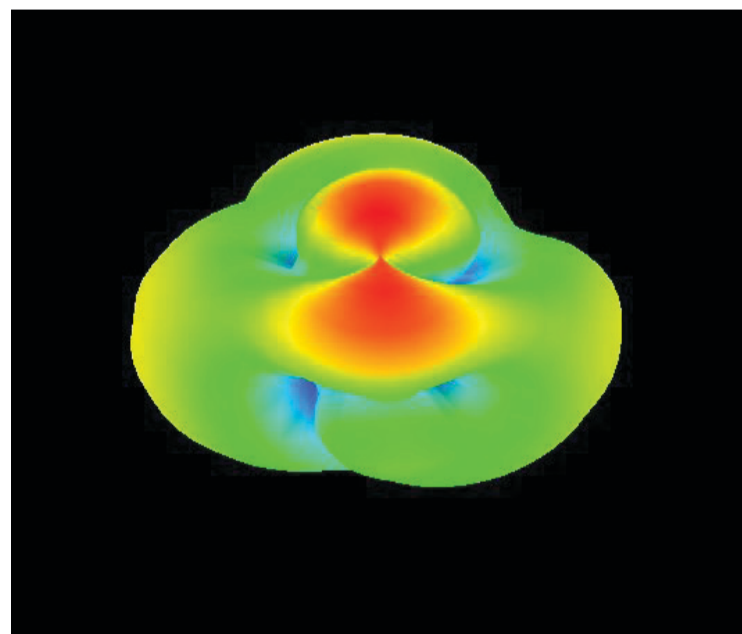



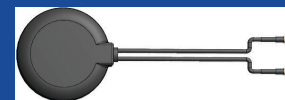

AEACBA081014-M698



Ø81.6 x 14.5 mm  
RoHS/RoHS II Compliant

MSL - N/A

**3D Radiation Patterns**

868 MHz

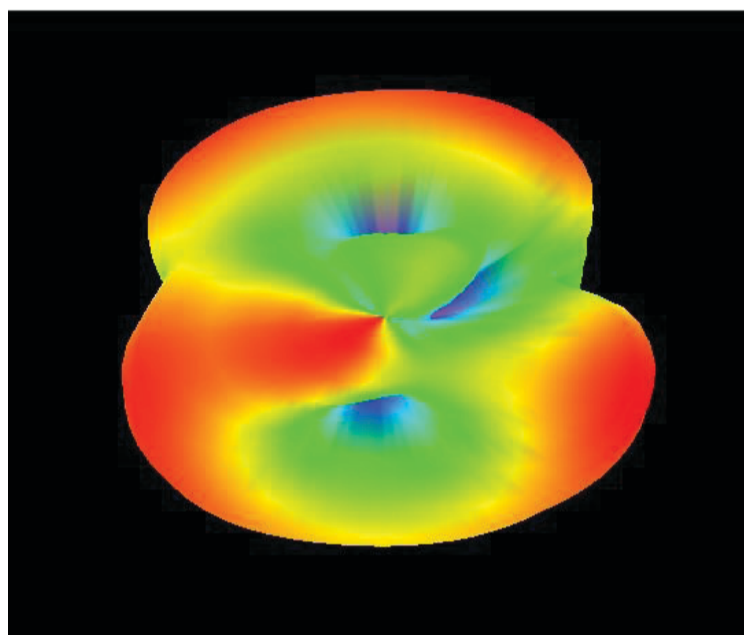

960 MHz

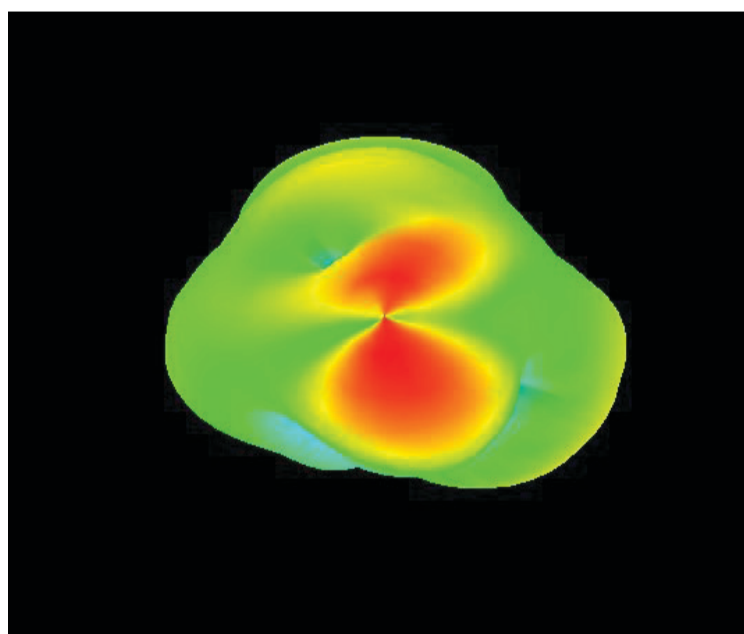

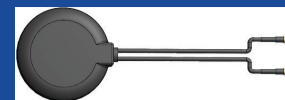

AEACBA081014-M698



Ø81.6 x 14.5 mm  
RoHS/RoHS II Compliant

MSL - N/A

**3D Radiation Patterns**

---

1710 MHz

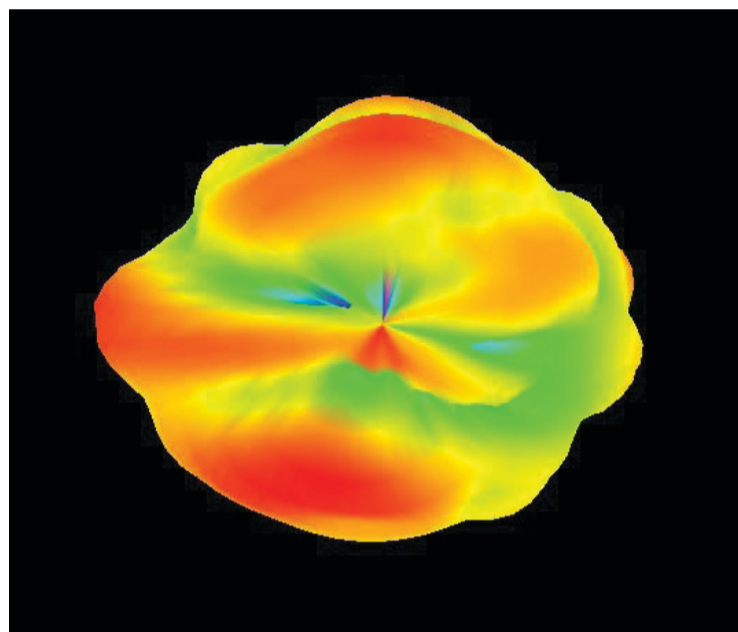

1850 MHz

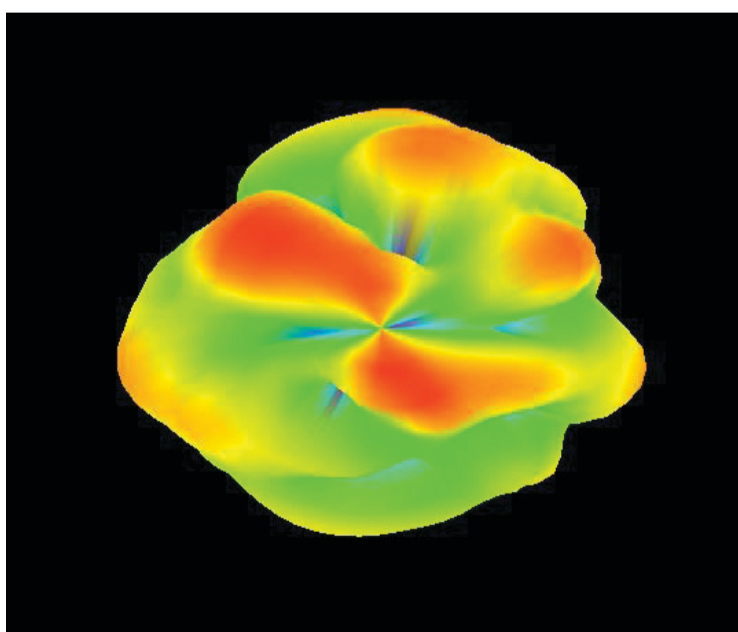

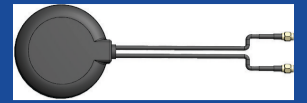

AEACBA081014-M698



Ø81.6 x 14.5 mm  
RoHS/RoHS II Compliant

MSL - N/A

**3D Radiation Patterns**

---

1990 MHz

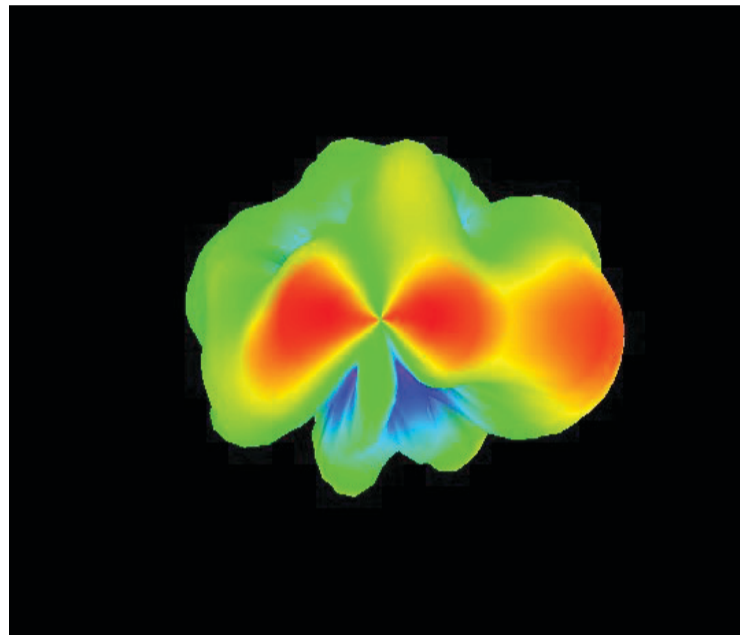

2170 MHz

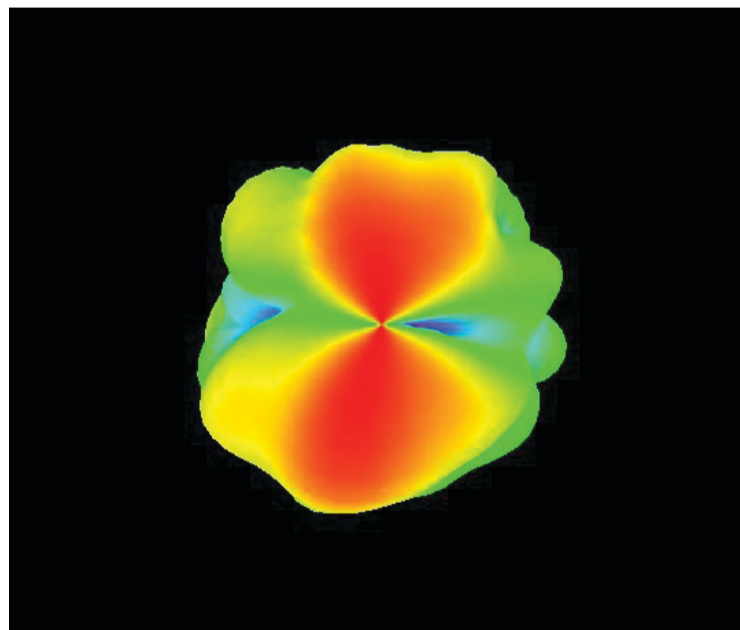

## 2x2 4G/LTE MIMO Antenna

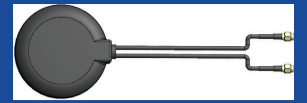

AEACBA081014-M698



Ø81.6 x 14.5 mm  
RoHS/RoHS II Compliant

MSL - N/A

### 3D Radiation Patterns

---

2690 MHz

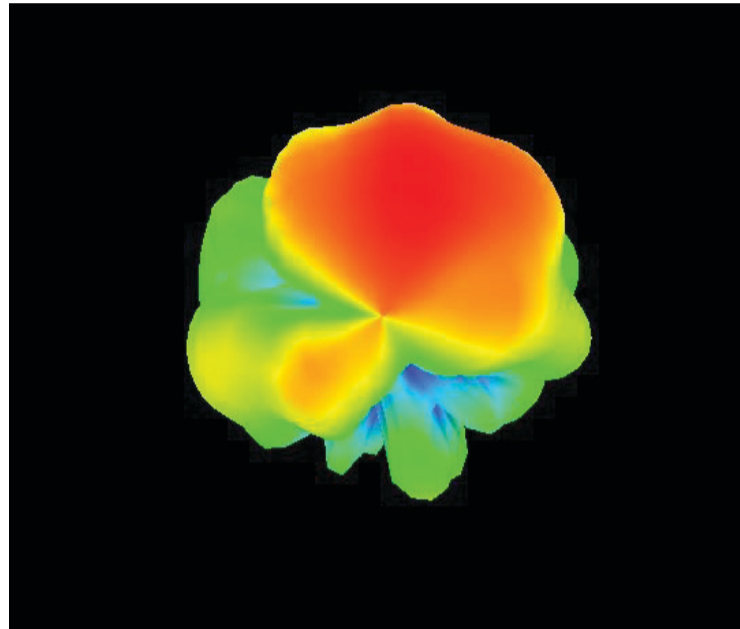

### Packaging

---

Each 70 x 32 x 15.5 mm size carton includes 50 pcs antenna, weighs 7.5 kg.

## X-ON Electronics

Largest Supplier of Electrical and Electronic Components

*Click to view similar products for [Antennas](#) category:*

*Click to view products by [Abracon](#) manufacturer:*

Other Similar products are found below :

[GAN30084EU](#) [930-033-R](#) [GW17.07.0250E](#) [1513563-1](#) [EXE902SM](#) [APAMPG-117](#) [MAF94383](#) [W3908B0100](#) [W6102B0100](#) [YE572113-30RSMM](#) [108-00014-50](#) [66089-2406](#) [A09-F8NF-M](#) [A09-F5NF-M](#) [RGFRA1903041A1T](#) [W3593B0100](#) [W3921B0100](#) [SIMNA-868](#) [SIMNA-915](#) [SIMNA-433](#) [W1044](#) [W1049B090](#) [A75-001](#) [WTL2449CQ1-FRSMM](#) [CPL9C](#) [EXB148BN](#) [0600-00060](#) [TRA9020S3PBN-001](#) [GD5W-28P-NF](#) [MA9-7N](#) [GD53-25](#) [GD5W-21P-NF](#) [EXB144SM](#) [C37](#) [MAF94051](#) [GD35-17P-NF](#) [P1744](#) [MA9-5N](#) [EXD420PL](#) [B1322NR](#) [QWFTB120](#) [MAF94271](#) [MAF94300](#) [GPSMB301](#) [FG4403](#) [AO-AGSM-OM54](#) [5200232](#) [MIKROE-2349](#) [WCM.01.0111](#) [MIKROE-2393](#)