

# External Combo Antenna LTE/GPS

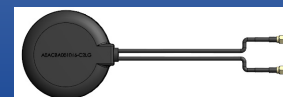

AEACBA081016-C2LG



Ø81.6 x 16.2 mm  
RoHS/RoHS II Compliant  
MSL = 1

## Features

- 4G/LTE full band coverage
- Active GPS with LNA gain of 28 dB
- IP67 rated
- Adhesive mount
- RHCP for GPS antenna

## Applications

- 4G/LTE/3G/2G/GSM applications
- GNSS/GPS
- Telematics
- M2M
- IoT and Industrial IoT
- Geolocation and tracking
- Transportation and agriculture
- Smart city

## Electrical Characteristics

Parameters	Min.	Typ.	Max.	Units	Note
LTE Antenna					
Frequency Range		698-960/1710-2690		MHz	
VSWR			3.0		
Polarization		Linear			
Impedance		50		Ω	
Gain		2.5		dB <sub>i</sub>	
GPS Antenna					
Center Frequency		1575.42±3		MHz	
Bandwidth		CF±5		MHz	
Polarization		RHCP			
Gain		2		dB <sub>i</sub> c	Zenith
VSWR			2.0		
Impedance		50			
Axial Ratio			3	dB	
LNA					
Gain		28±2		dB	
Noise Figure			1.5	dB	
VSWR			2.0		
Supply Voltage		2.2~5.0		V	DC
Current Consumption			15	mA	

# External Combo Antenna LTE/GPS

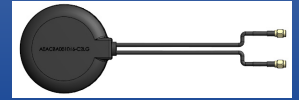

AEACBA081016-C2LG



Ø81.6 x 16.2 mm  
RoHS/RoHS II Compliant  
MSL = 1

## Mechanical Characteristics

Parameters	Description
Connector	SMA Male
Cable Type	RG174
Cable Length	3M
Material	ABS
Mount way	Adhesive
Dimensions	Φ81.6x16.2mm

## Environmental Characteristics

Parameters	Description
Waterproof	IP67
Operating Temperature	-40 ~ +85°C
Relative Humidity	Up to 95%
MSL Level	1
ROHS Compliant	Yes
Vibration	10 to 55Hz with 1.5mm amplitude 2 hours

# External Combo Antenna LTE/GPS

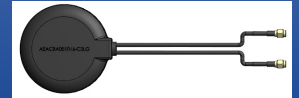

AEACBA081016-C2LG



Ø81.6 x 16.2 mm  
RoHS/RoHS II Compliant  
MSL = 1

## Dimensions

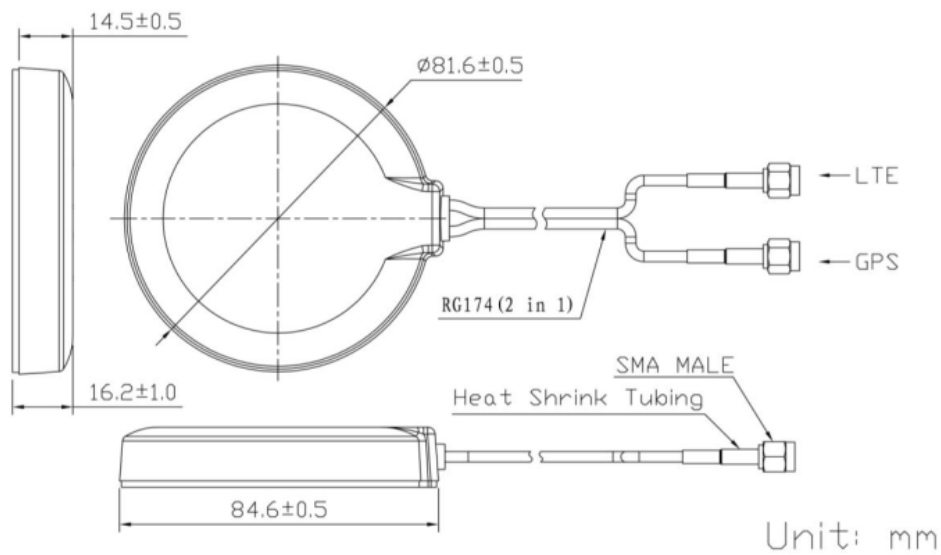

## Product Image

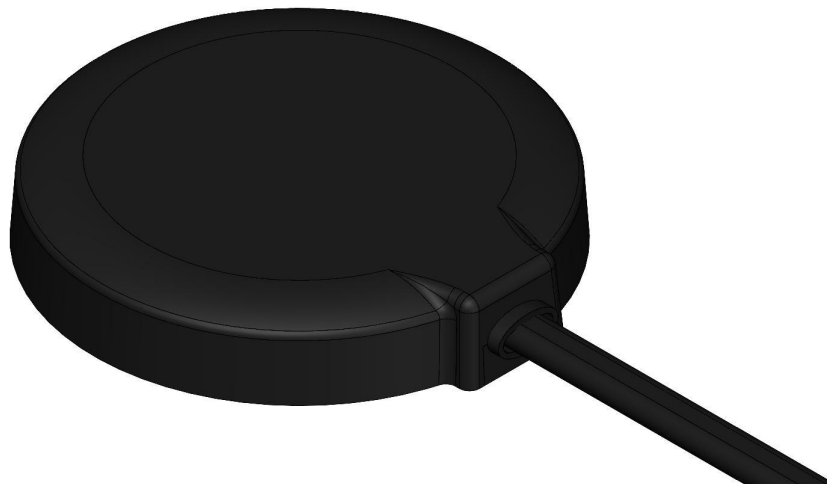

# External Combo Antenna LTE/GPS

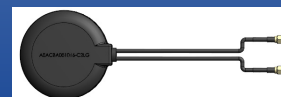

AEACBA081016-C2LG



Ø81.6 x 16.2 mm  
RoHS/RoHS II Compliant  
MSL = 1

## VSWR Characteristics

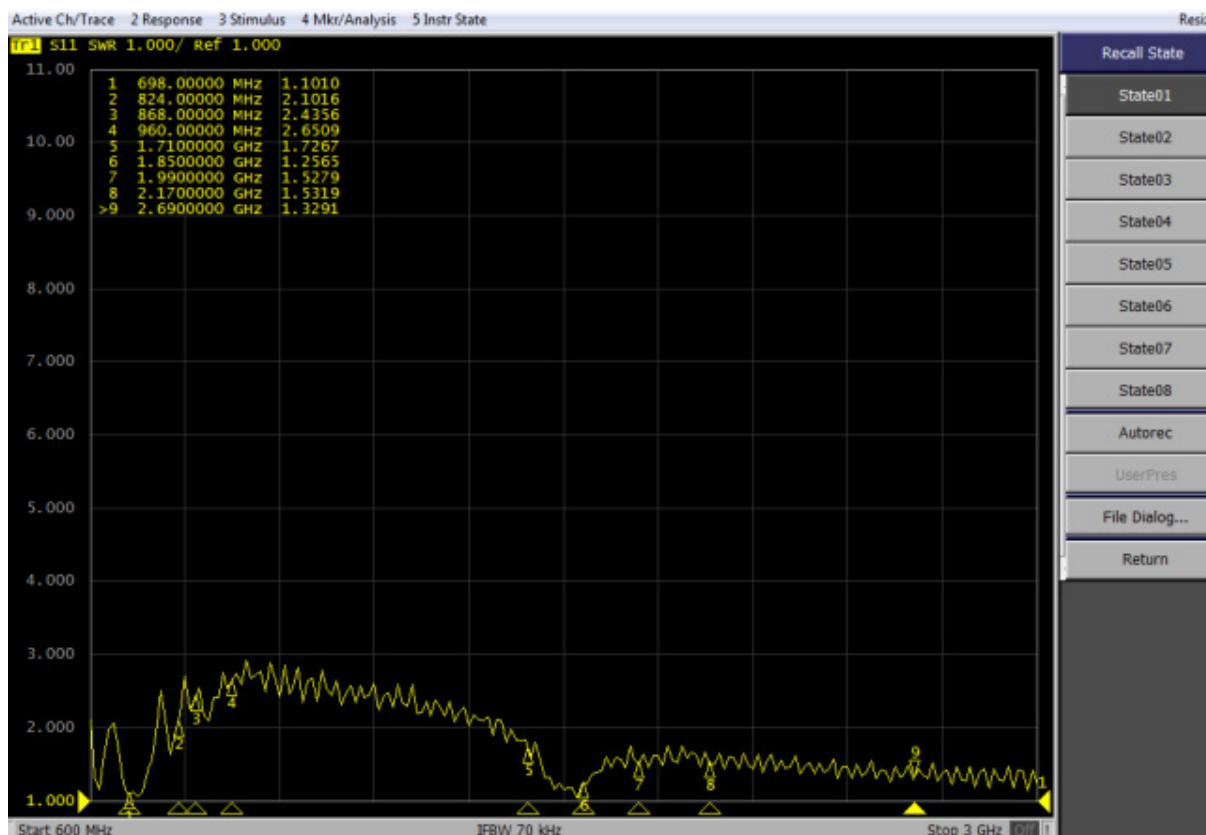

## Gain and Efficiency

Frequency (MHz)	Efficiency	Gain (dBi)
698	0.69	2.23
824	0.58	2.38
868	0.55	1.12
960	0.54	1.0
1710	0.57	0.9
1850	0.52	0.3
1990	0.57	0.73
2170	0.59	1.96
2690	0.58	1.94

# External Combo Antenna LTE/GPS



AEACBA081016-C2LG



Ø81.6 x 16.2 mm  
RoHS/RoHS II Compliant  
MSL = 1

## Radiation Patterns

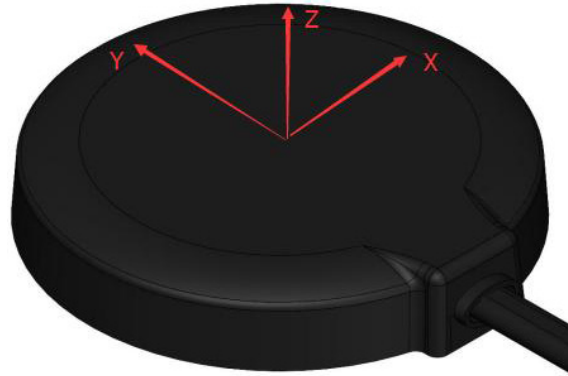

## 2D Radiation Patterns

GPS Antenna

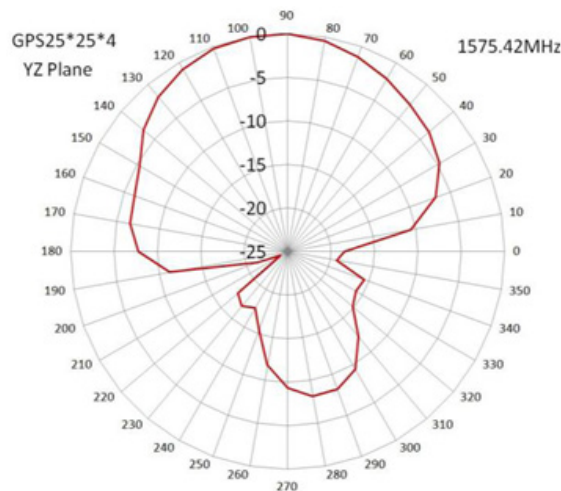
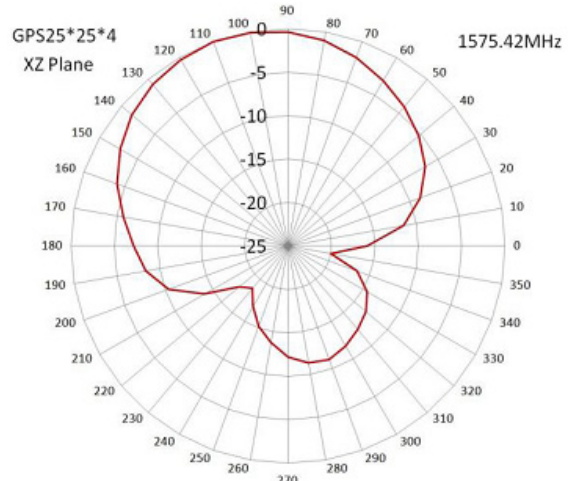
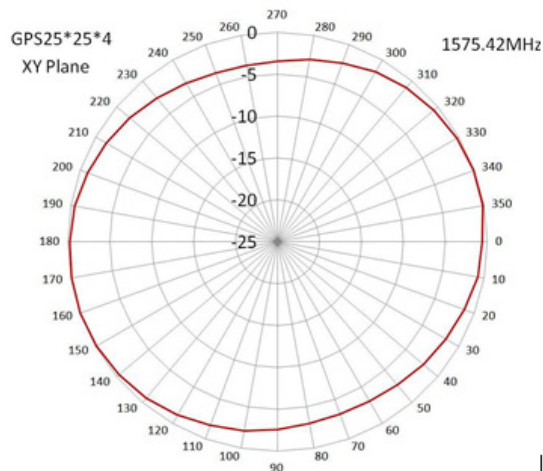

# External Combo Antenna LTE/GPS

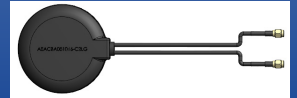

AEACBA081016-C2LG



Ø81.6 x 16.2 mm  
RoHS/RoHS II Compliant  
MSL = 1

## 2D Radiation Patterns

### LTE Antenna

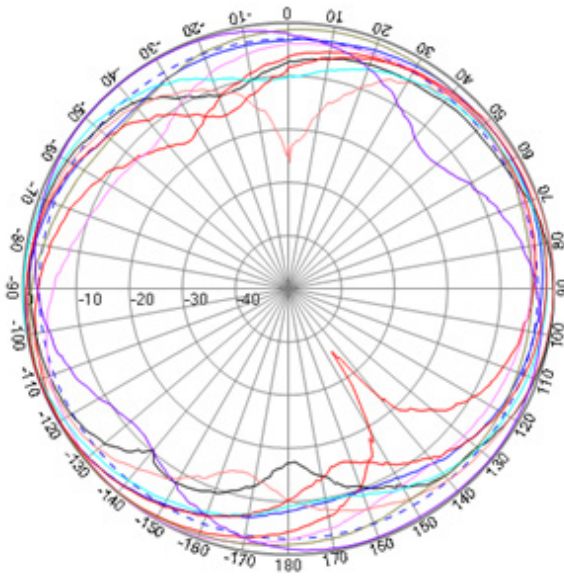

XY PLANE

- Freq: 700
- Freq: 824
- Freq: 868
- Freq: 960
- Freq: 1710
- Freq: 1850
- Freq: 1990
- Freq: 2170
- Freq: 2690

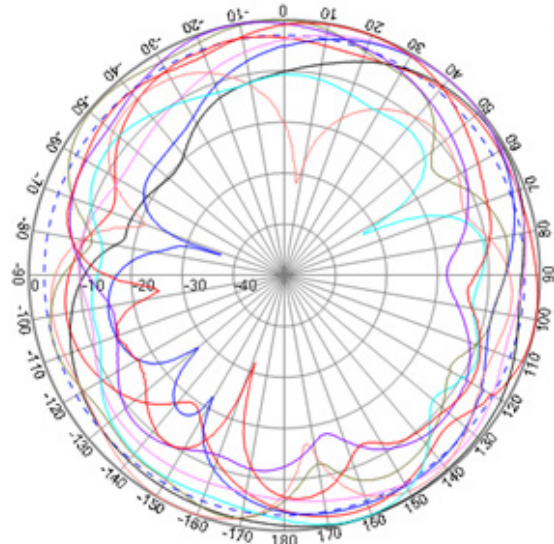

XZ PLANE

- Freq: 700
- Freq: 824
- Freq: 868
- Freq: 960
- Freq: 1710
- Freq: 1850
- Freq: 1990
- Freq: 2170
- Freq: 2690

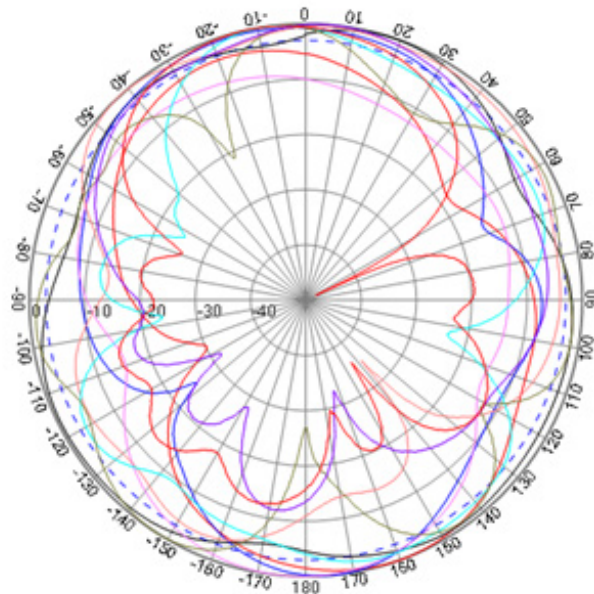

YZ PLANE

- Freq: 700
- Freq: 824
- Freq: 868
- Freq: 960
- Freq: 1710
- Freq: 1850
- Freq: 1990
- Freq: 2170
- Freq: 2690

# External Combo Antenna LTE/GPS

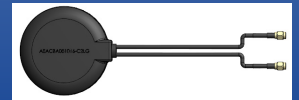

AEACBA081016-C2LG



Ø81.6 x 16.2 mm  
RoHS/RoHS II Compliant  
MSL = 1

## 3D Radiation Patterns

### GPS Antenna

1575.42 MHz

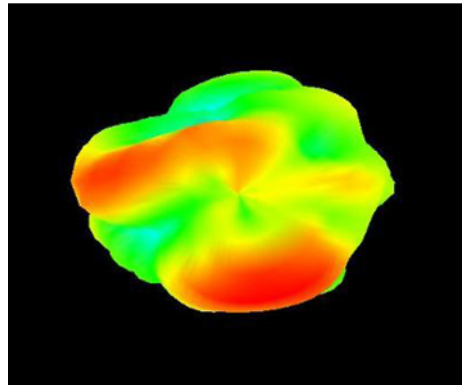

### LTE Antenna

700 MHz

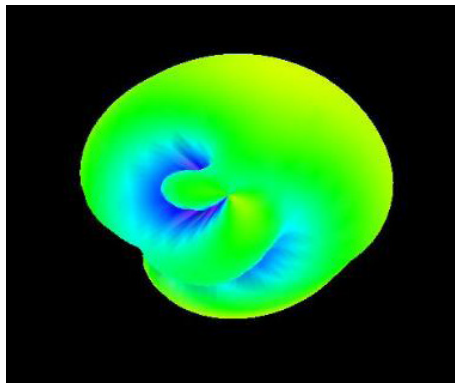

824 MHz

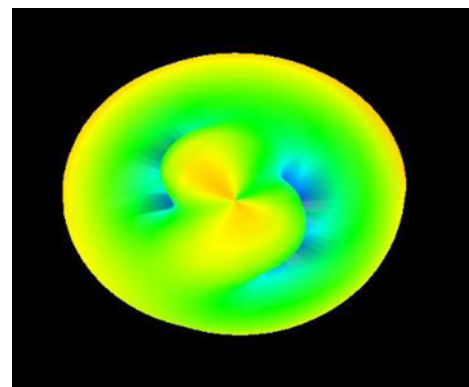

868 MHz

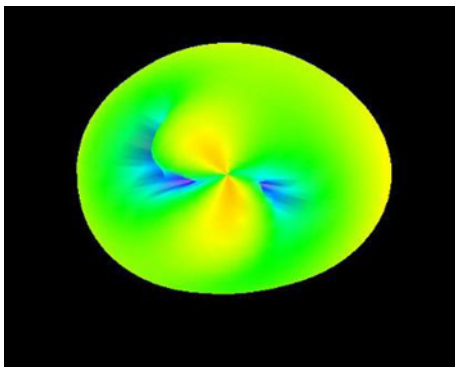

960 MHz

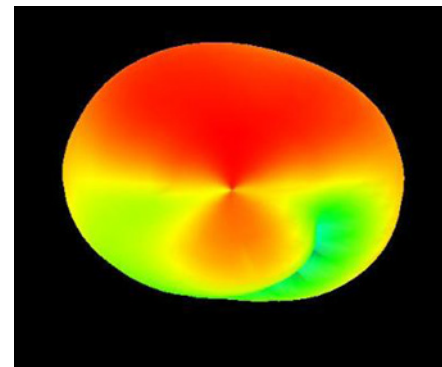

# External Combo Antenna LTE/GPS

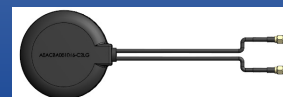

AEACBA081016-C2LG



Ø81.6 x 16.2 mm  
RoHS/RoHS II Compliant  
MSL = 1

## 3D Radiation Patterns

1710 MHz

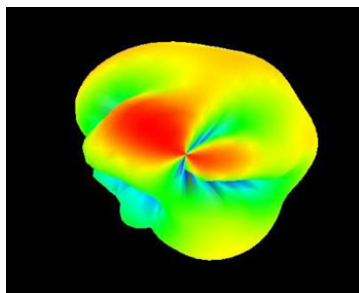

1850 MHz

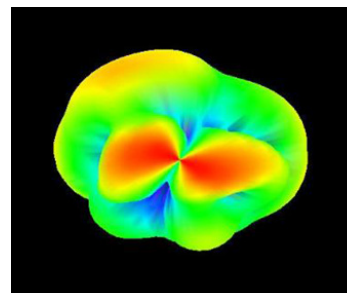

1990 MHz

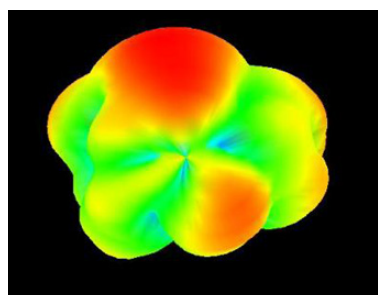

2170 MHz

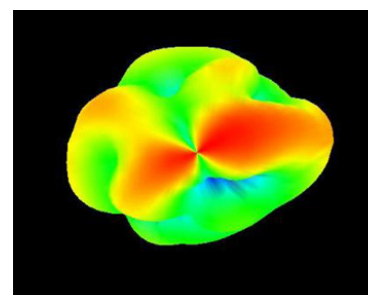

2690 MHz

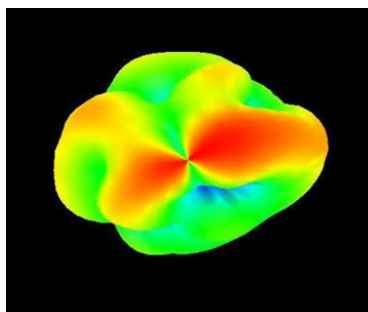

## Packaging

Each 49.5 x 22.5 x 27 cm size carton includes 50 pcs antenna, weighs 7.5 kg.

**ATTENTION:** Abracon LLC's products are COTS – Commercial-Off-The-Shelf products; suitable for Commercial, Industrial and, where designated, Automotive Applications. Abracon's products are not specifically designed for Military, Aviation, Aerospace, Life-dependant Medical applications or any application requiring high reliability where component failure could result in loss of life and/or property. For applications requiring high reliability and/or presenting an extreme operating environment, written consent and authorization from Abracon LLC is required. Please contact Abracon LLC for more information.



5101 Hidden Creek Ln Spicewood TX 78669  
Phone: 512-371-6159 | Fax: 512-351-8858  
For terms and conditions of sales, please visit:  
[www.abracon.com](http://www.abracon.com)

REVISED: 11.09.2018

ABRACON IS  
ISO9001-2015  
CERTIFIED



## X-ON Electronics

Largest Supplier of Electrical and Electronic Components

*Click to view similar products for [Antennas](#) category:*

*Click to view products by [Abracon](#) manufacturer:*

Other Similar products are found below :

[GAN30084EU](#) [930-033-R](#) [GW17.07.0250E](#) [1513563-1](#) [EXE902SM](#) [APAMPG-117](#) [MAF94383](#) [W3908B0100](#) [W6102B0100](#) [YE572113-30RSMM](#) [108-00014-50](#) [66089-2406](#) [A09-F8NF-M](#) [A09-F5NF-M](#) [RGFRA1903041A1T](#) [W3593B0100](#) [W3921B0100](#) [SIMNA-868](#) [SIMNA-915](#) [SIMNA-433](#) [W1044](#) [W1049B090](#) [A75-001](#) [WTL2449CQ1-FRSMM](#) [CPL9C](#) [EXB148BN](#) [0600-00060](#) [TRA9020S3PBN-001](#) [GD5W-28P-NF](#) [MA9-7N](#) [GD53-25](#) [GD5W-21P-NF](#) [EXB144SM](#) [C37](#) [MAF94051](#) [GD35-17P-NF](#) [P1744](#) [MA9-5N](#) [EXD420PL](#) [B1322NR](#) [QWFTB120](#) [MAF94271](#) [MAF94300](#) [GPSMB301](#) [FG4403](#) [AO-AGSM-OM54](#) [5200232](#) [MIKROE-2349](#) [WCM.01.0111](#) [MIKROE-2393](#)