

Active Multiband GNSS External Antenna



AEACBD050018-SG3



50.0 x 50.0 x 18.0 mm
RoHS/RoHS II Compliant
MSL = 1

Features

- High positioning accuracy
- GPS/GLONASS/BeiDou/Galileo band support
- IP67 Rated
- Gain of 5.0 dBic
- Active GNSS with integrated LNA
- High LNA gain of 34 dB
- Low VSWR of 1.5
- RHCP polarization
- Magnetic mounting
- Improved GNSS reliability

Applications

- GPS/GLONASS/BeiDou/Galileo applications
- IoT
- M2M
- Surveillance
- Fleet management and asset tracking
- Autonomous driving
- Telematics
- Agriculture
- Instrumentation
- Survey

Electrical Specifications

Parameters	Min.	Typ.	Max.	Units	Note
Frequency Range		1561.098 ~ 1602		MHz	
VSWR			1.5		
Polarization		RHCP			Right Hand Circular Polarization
Impedance		50		Ω	
Gain		5		dBic	@PCB Zenith
Axial Ratio			3	dB	

LNA Parameters	Min.	Typ.	Max.	Units	Note
Gain	32	34	36	dB	
VSWR			2.0		
Noise Figure			1.5	dB	
Supply Voltage		3~5		V	DC
Current Consumption			20	mA	

Mechanical Characteristics

Parameters	Description
Connector	SMA
Cable Type	RG174/3M
Mounting	Magnet
Radom Material	ABS

Active Multiband GNSS External Antenna



AEACBD050018-SG3



50.0 x 50.0 x 18.0 mm
RoHS/RoHS II Compliant
MSL = 1

Environmental Characteristics

Parameters	Description
Ingress Protection	IP67 rated
Operating temperature	-40°C to +85°C
Relative Humidity	Up to 95 %
Vibration	10 to 55 Hz with 1.5 mm amplitude 2 hours

Dimensions

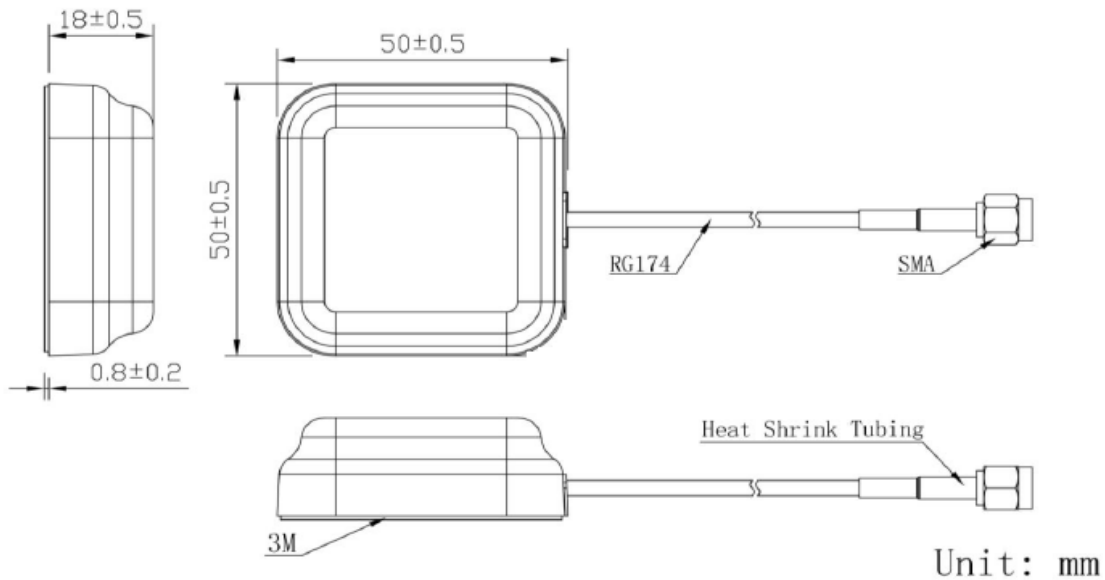

Product Image



Active Multiband GNSS External Antenna



AEACBD050018-SG3



50.0 x 50.0 x 18.0 mm
RoHS/RoHS II Compliant
MSL = 1

VSWR

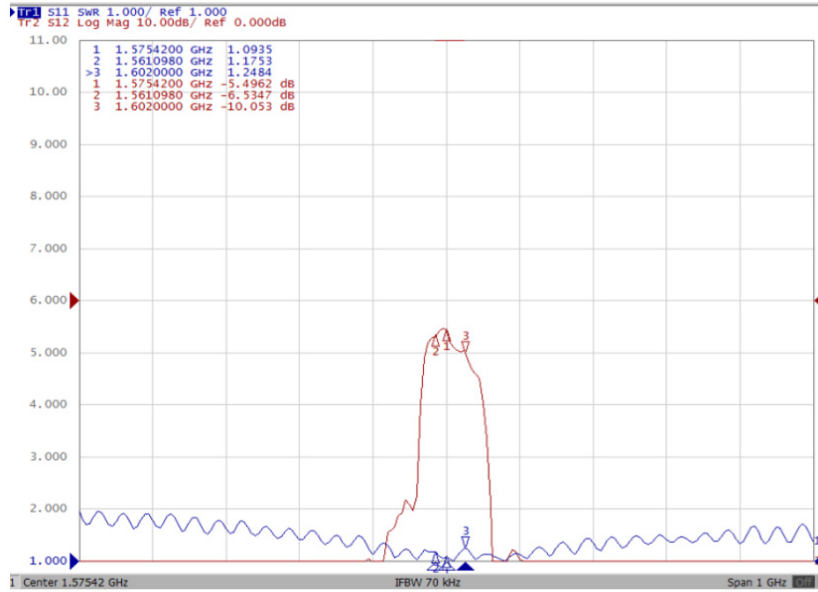

Radiation Patterns:

2D- Pattern

Frequency: --- 1561 --- 1575 --- 1602

XY - Plane

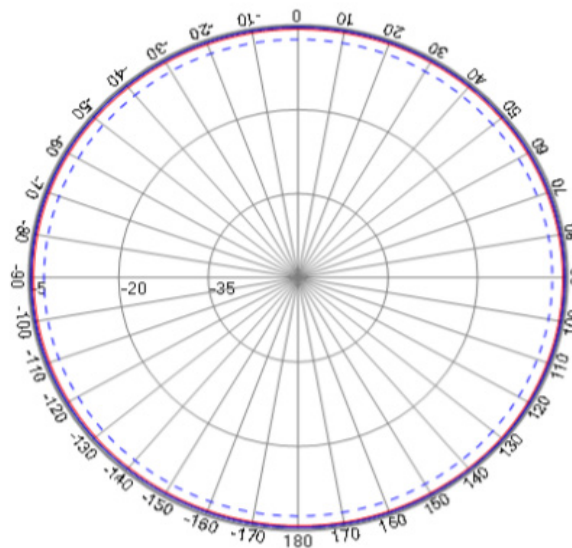

ATTENTION: Abracon LLC's products are COTS – Commercial-Off-The-Shelf products; suitable for Commercial, Industrial and, where designated, Automotive Applications. Abracon's products are not specifically designed for Military, Aviation, Aerospace, Life-dependent Medical applications or any application requiring high reliability where component failure could result in loss of life and/or property. For applications requiring high reliability and/or presenting an extreme operating environment, written consent and authorization from Abracon LLC is required. Please contact Abracon LLC for more information.



5101 Hidden Creek Ln Spicewood TX 78669
Phone: 512-371-6159 | Fax: 512-351-8858
For terms and conditions of sales, please visit:
www.abracon.com

REVISED: 01.25.2019

ABRACON IS
ISO9001-2015
CERTIFIED

Active Multiband GNSS External Antenna



AEACBD050018-SG3



50.0 x 50.0 x 18.0 mm
RoHS/RoHS II Compliant
MSL = 1

Radiation Patterns:

XZ - Plane

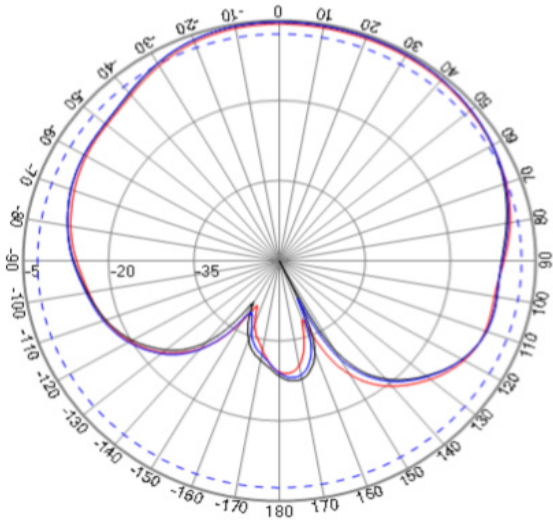

YZ - Plane

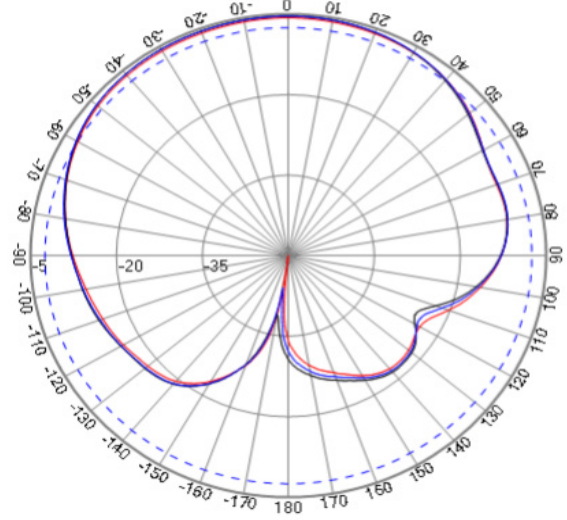

3D- Pattern

Frequency: 1561 MHz

Frequency: 1575.42 MHz

Frequency: 1602 MHz

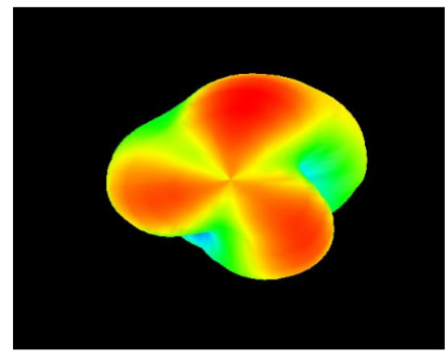
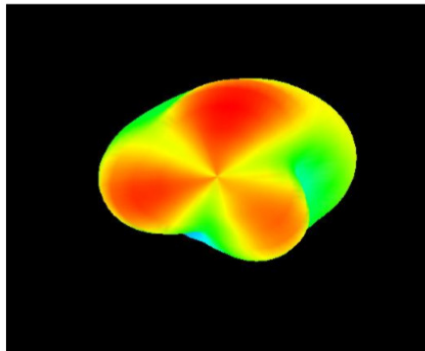
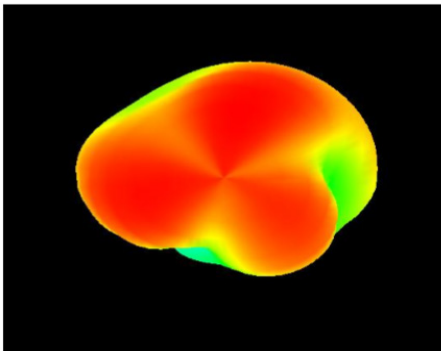

Packaging

The carton weighs of 15 Kgs and has 100 pieces in a dimension of 70.0 x 32.0 x 16.0 cm.



5101 Hidden Creek Ln Spicewood TX 78669
Phone: 512-371-6159 | Fax: 512-351-8858
For terms and conditions of sales, please visit:
www.abracon.com

REVISED: 01.25.2019

ABRACON IS
ISO9001-2015
CERTIFIED

X-ON Electronics

Largest Supplier of Electrical and Electronic Components

Click to view similar products for [Antennas](#) category:

Click to view products by [Abracon](#) manufacturer:

Other Similar products are found below :

[GAN30084EU](#) [930-033-R](#) [GW17.07.0250E](#) [1513563-1](#) [EXE902SM](#) [APAMPG-117](#) [MAF94383](#) [W3908B0100](#) [W6102B0100](#) [YE572113-30RSMM](#) [108-00014-50](#) [66089-2406](#) [A09-F8NF-M](#) [A09-F5NF-M](#) [RGFRA1903041A1T](#) [W3593B0100](#) [W3921B0100](#) [SIMNA-868](#) [SIMNA-915](#) [SIMNA-433](#) [W1044](#) [W1049B090](#) [A75-001](#) [WTL2449CQ1-FRSMM](#) [CPL9C](#) [EXB148BN](#) [0600-00060](#) [TRA9020S3PBN-001](#) [GD5W-28P-NF](#) [MA9-7N](#) [GD53-25](#) [GD5W-21P-NF](#) [EXB144SM](#) [C37](#) [MAF94051](#) [GD35-17P-NF](#) [P1744](#) [MA9-5N](#) [EXD420PL](#) [B1322NR](#) [QWFTB120](#) [MAF94271](#) [MAF94300](#) [GPSMB301](#) [FG4403](#) [AO-AGSM-OM54](#) [5200232](#) [MIKROE-2349](#) [WCM.01.0111](#) [MIKROE-2393](#)