

WiFi + GPS Combinational External Antenna



AEACBK046014-C2WG



ESD Sensitive



Ø46.6 x 14.5 mm
RoHS/RoHS II Compliant

MSL = N/A: NOT APPLICABLE

FEATURES

- IP67 Dust and Waterproof
- 1574.42MHz/2450MHz/5500MHz frequencies
- LNA Gain up to 20dBi+/-2dB
- VSWR ≤ 1.5/2.5 for GPS/WiFi
- RHCP/Linear polarization for GPS/WiFi

APPLICATIONS

- GPS/GLONASS
- WiFi/Bluetooth/Zigbee,
- ISM devices
- Use on outdoor and indoor assets
- M2M
- Telematics
- Commercial vehicles/ Fleet management
- Remote Technology/Monitoring

ELECTRICAL SPECIFICATIONS

Parameters	Min.	Typ.	Max.	Units	Note
Frequency		1575.42 ± 3MHz		MHz	
Bandwidth		CF ± 4MHz		MHz	
VSWR			1.5		
Polarization		RHCP			(Right Hand Circular Polarization)
Impedance		50		Ω	
Gain		0		dBi	(Zenith)
Operating Temperature	-40		+85	°C	
Input Power			10	W	

LOW NOISE AMPLIFIER (LNA)

Parameters	Min.	Typ.	Max.	Units	Note
DC Voltage		3.3		V	
Gain		20±2dB		dB	
Output VSWR			2.0		
Noise Figure			1.5	dB	
DC current			10	mA	

Wifi ANTENNA

Parameters	Min.	Typ.	Max.	Units	Note
Frequency Range		2400~2483.5/4800~5825		MHz	
VSWR			2.5		
Polarization Model		Linear			
Impedance		50		Ω	
Gain		2		dBi	(Zenith)
Operating Temperature	-40		+85	°C	
Input Power			10	W	

WiFi + GPS Combinational External Antenna

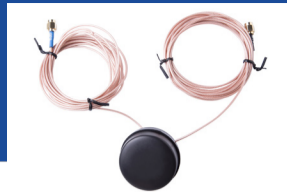

AEACBK046014-C2WG



ESD Sensitive



RoHS/RoHS II Compliant

Ø46.6 x 14.5 mm

MSL = N/A: NOT APPLICABLE

RETURN - LOSS CHARACTERISTICS

RETURN - LOSS CHARACTERISTICS

GPS S11 Return Loss

WiFi S11 Return Loss

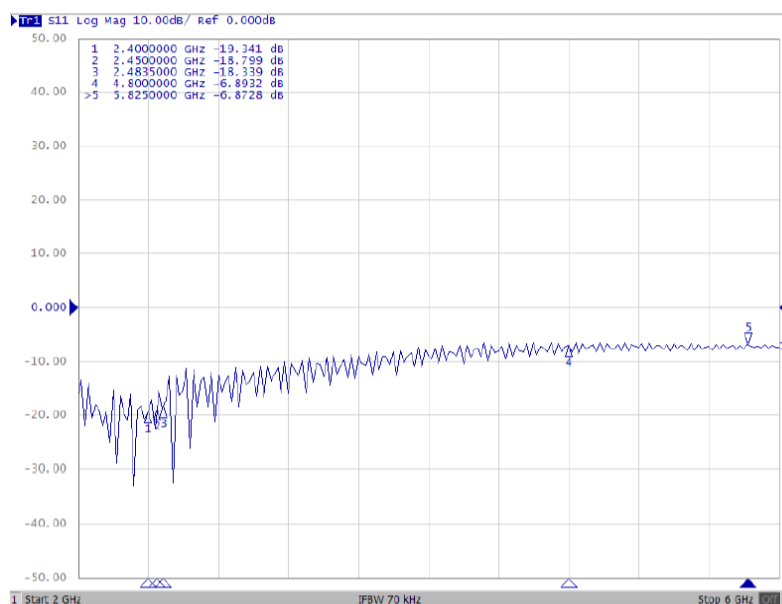
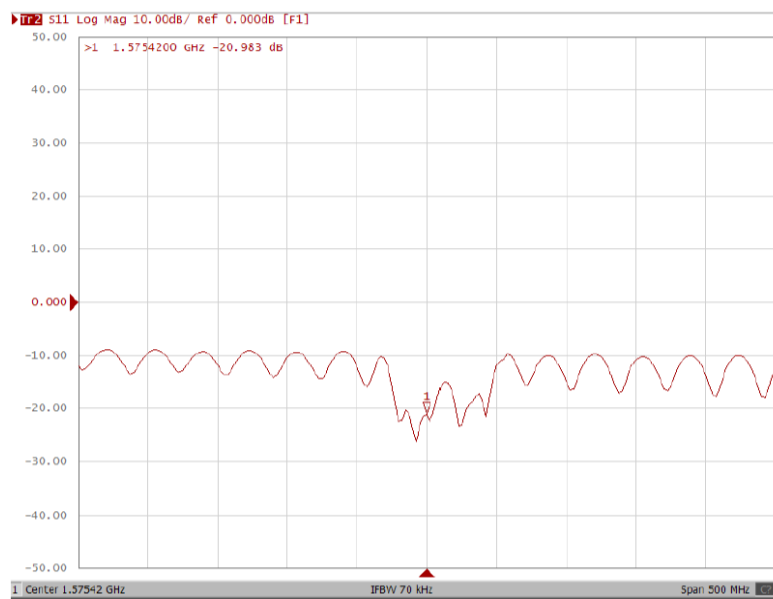

RADIATION PATTERNS

GPS Antenna 2D Patterns

XY Plane

XZ Plane

YZ Plane

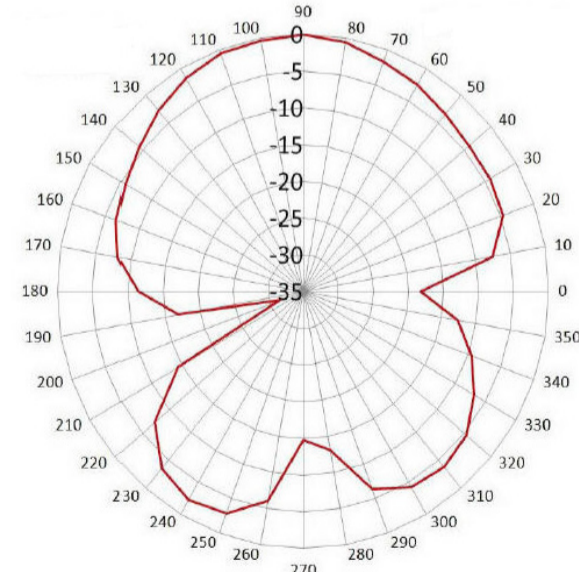
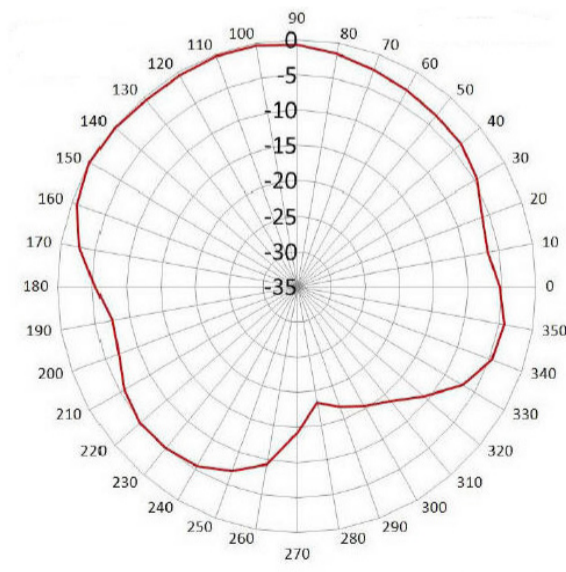
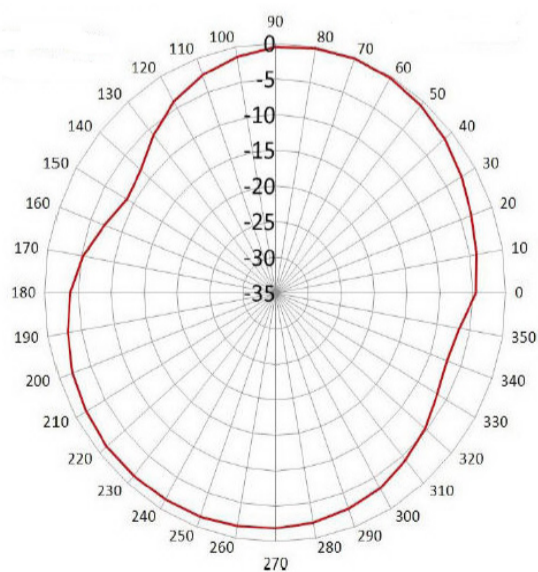

WiFi + GPS Combinational External Antenna

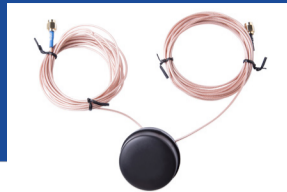

AEACBK046014-C2WG



ESD Sensitive



Ø46.6 x 14.5 mm
RoHS/RoHS II Compliant

MSL = N/A: NOT APPLICABLE

RADIATION PATTERNS

WiFi Antenna 2D Patterns

XY Plane

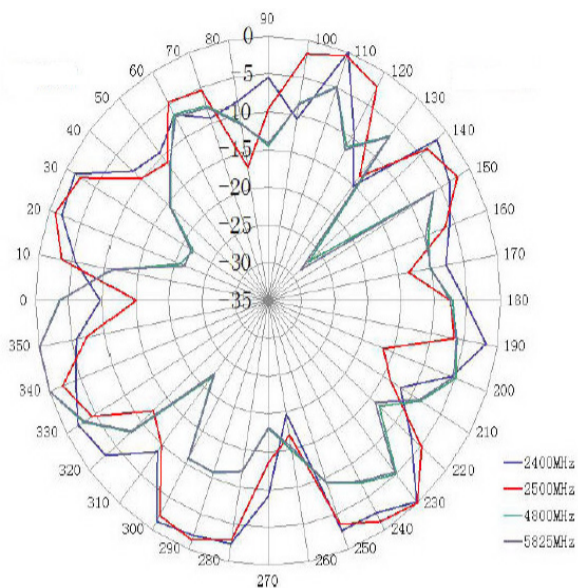

XZ Plane

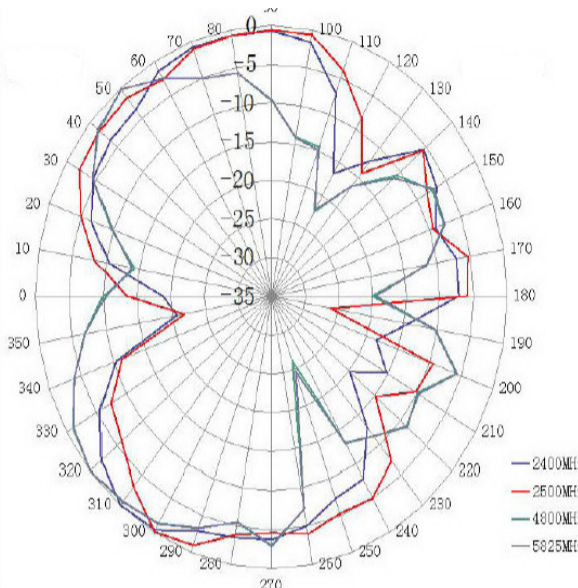

YZ Plane

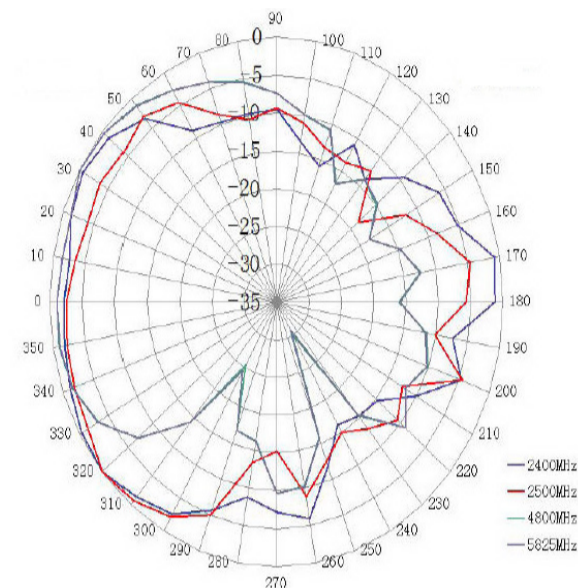

WiFi Antenna 3D Pattern

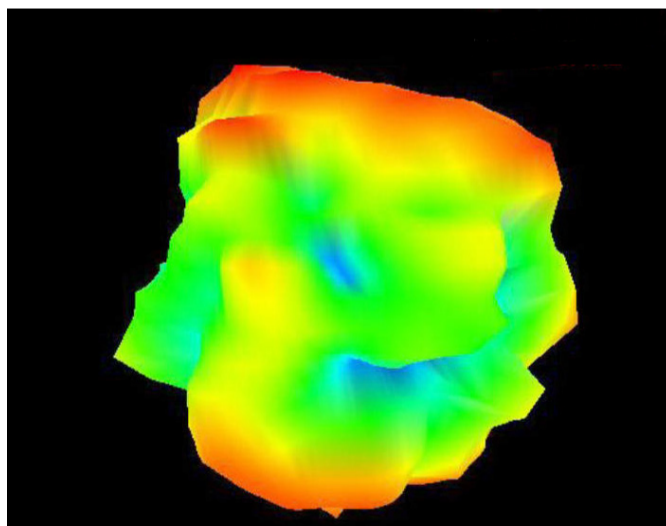

Frequency (MHz)	2400	2450	2483
Peak Gain (dBi)	-4.2	-4.50	-4.53
Efficiency (%)	61	61	63

WiFi + GPS Combinational External Antenna

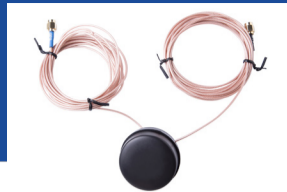

AEACBK046014-C2WG



ESD Sensitive



Ø46.6 x 14.5 mm
RoHS/RoHS II Compliant

MSL = N/A: NOT APPLICABLE

DIMENSIONS

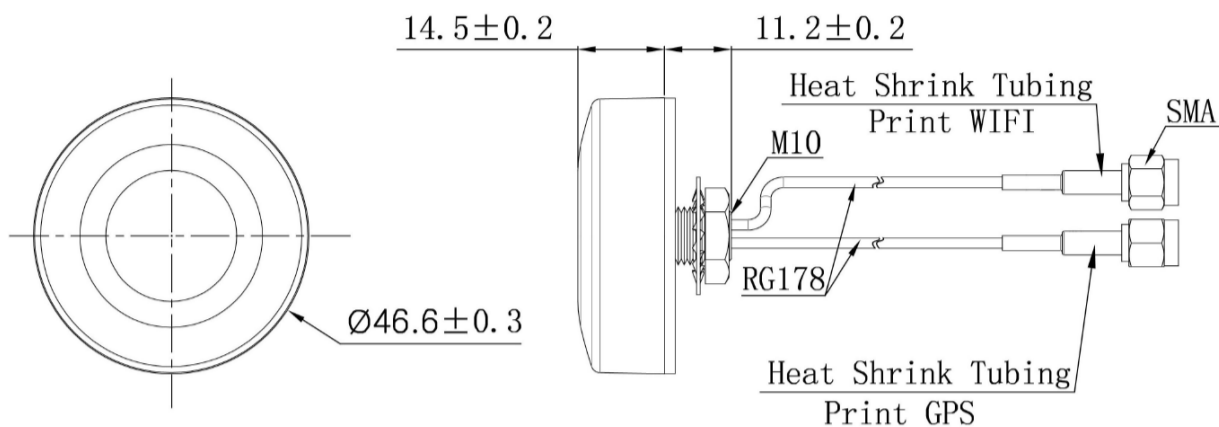

Unit: mm

Parameters	Description
Cable Length	3.00 m
RF Cable	RG178
RF Connector	SMA and others
Radome Material	ABS
Mounting Type	Screw



PACKAGING

Each 700 x 320 x 155 mm size carton includes 100 pcs antenna, 8kgs/carton.

Unit: mm

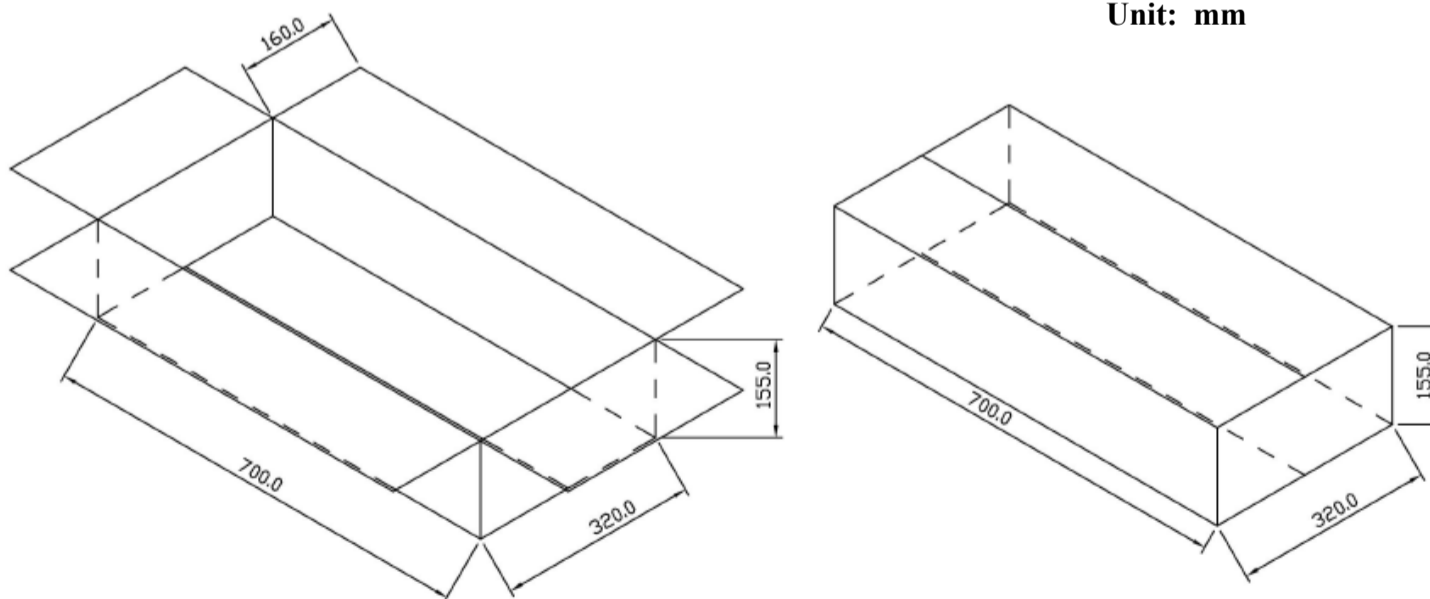

X-ON Electronics

Largest Supplier of Electrical and Electronic Components

Click to view similar products for [Antennas](#) category:

Click to view products by [ABRACON](#) manufacturer:

Other Similar products are found below :

[GAN30084EU](#) [930-033-R](#) [GW17.07.0250E](#) [1513563-1](#) [EXE902SM](#) [APAMPG-117](#) [MAF94383](#) [W3908B0100](#) [W6102B0100](#) [YE572113-30RSMM](#) [108-00014-50](#) [66089-2406](#) [A09-F8NF-M](#) [A09-F5NF-M](#) [RGFRA1903041A1T](#) [W3593B0100](#) [W3921B0100](#) [SIMNA-868](#) [SIMNA-915](#) [SIMNA-433](#) [W1044](#) [W1049B090](#) [A75-001](#) [WTL2449CQ1-FRSMM](#) [CPL9C](#) [EXB148BN](#) [0600-00060](#) [TRA9020S3PBN-001](#) [GD5W-28P-NF](#) [MA9-7N](#) [GD53-25](#) [GD5W-21P-NF](#) [EXB144SM](#) [C37](#) [MAF94051](#) [GD35-17P-NF](#) [P1744](#) [MA9-5N](#) [EXD420PL](#) [B1322NR](#) [QWFTB120](#) [MAF94271](#) [MAF94300](#) [GPSMB301](#) [FG4403](#) [AO-AGSM-OM54](#) [5200232](#) [MIKROE-2349](#) [WCM.01.0111](#) [MIKROE-2393](#)