

# GPS/Beidou/Glonass/Galileo/QZSS External Antenna



AEAGMK148060-S1575



ESD Sensitive



Ø148.0 x 60.0mm  
RoHS/RoHS II Compliant

MSL = NOT APPLICABLE

## FEATURES

- Gain of 4.5dBic
- Multiband
- RHCP polarization
- LNA gain of 38 dB
- Covers GPS (L1/L2/L5,L6), BEIDOU (B1/B2/B3), GLONASS (L1/L2), Galileo (L1/E5b/E5a), QZSS(L1/L2/L5/L6) bands

## APPLICATIONS

- GPS
- Beidou
- GLONASS
- Galileo
- QZSS
- IoT
- Remote technology/monitoring
- M2M

## ELECTRICAL SPECIFICATIONS

Parameters	Min.	Typ.	Max.	Units	Note
Frequency Range		1164-1300;1559-1615		MHz	GPS: L1/L2/L5/L6 BEIDOU: B1/B2/B3 GLONASS: L1/L2 Galileo: L1/E5b/E5a QZSS: L1/L2/L5/L6
VSWR		2.0			
Polarization		RHCP			Right Hand Circular Polarization
Impedance		50		Ω	
Gain		4.5		dBic	Zenith
Phase Center			2.0	mm	
Axial Ratio			2.0		Zenith
Operating Temperature	-40		+85	°C	

## LOW NOISE AMPLIFIER (LNA)

Parameters	Min.	Typ.	Max.	Units	Note
DC Voltage		3.0 ~ 16.0		V	
DC current			30	mA	16mA @ 3.3V
Gain	36	38	40	dB	
Output VSWR		2.0		dB	
Out Band Rejection	40			dB	FH+100MHz FL-100MHz
Noise Figure			1.5	dB	



5101 Hidden Creek Ln Spicewood TX 78669  
Phone: 512-371-6159 | Fax: 512-351-8858  
For terms and conditions of sales, please visit:  
[www.abracon.com](http://www.abracon.com)

REVISED: 08.12.2019

ABRACON IS  
ISO9001-2015  
CERTIFIED

# GPS/Beidou/Glonass/Galileo/QZSS External Antenna



AEAGMK148060-S1575



ESD Sensitive



Ø148.0 x 60.0mm  
RoHS/RoHS II Compliant

MSL = NOT APPLICABLE

## OVERALL (Module + RF connector)

Parameters	Min.	Typ.	Max.	Units	Note
Output VSWR		2.0			
Gain		38		dB	
Impedance		50		Ω	

## ENVIRONMENTAL CHARACTERISTICS:

Parameters	Description
Vibration	Sine sweep 1g(0-p) 10 to 55Hz 10Hz each axis
Storage Temperature	-55 °C to +85 °C
ROHS	ROHS Compliant
MSL Level	N/A
ESD Sensitive	This device is ESD sensitive
Handling	No special handling conditions
Ingress Protection	IP66

## MECHANICAL DIMENSIONS

No.	Parameters	Description
1	Antenna	PTFE F4B-1/2
2	PCB	FR4
3	Shielding	Tinplate
4	RF Connector	TNC-K
5	Threaded Hole	Copper
6	Plastic Shell	ABS

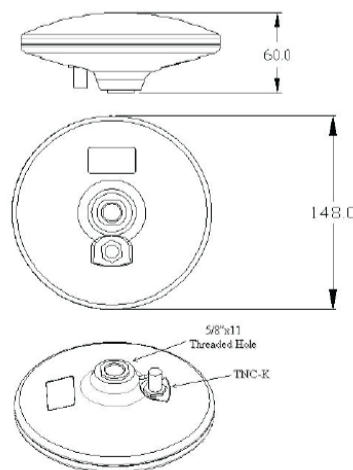

Unit: mm



5101 Hidden Creek Ln Spicewood TX 78669  
Phone: 512-371-6159 | Fax: 512-351-8858  
For terms and conditions of sales, please visit:  
[www.abracon.com](http://www.abracon.com)

REVISED: 08.12.2019

ABRACON IS  
ISO9001-2015  
CERTIFIED

# GPS/Beidou/Glonass/Galileo/QZSS External Antenna



AEAGMK148060-S1575



ESD Sensitive



Ø148.0 x 60.0mm  
RoHS/RoHS II Compliant  
MSL = NOT APPLICABLE

## RETURN - LOSS CHARACTERISTICS

S11 Return Loss

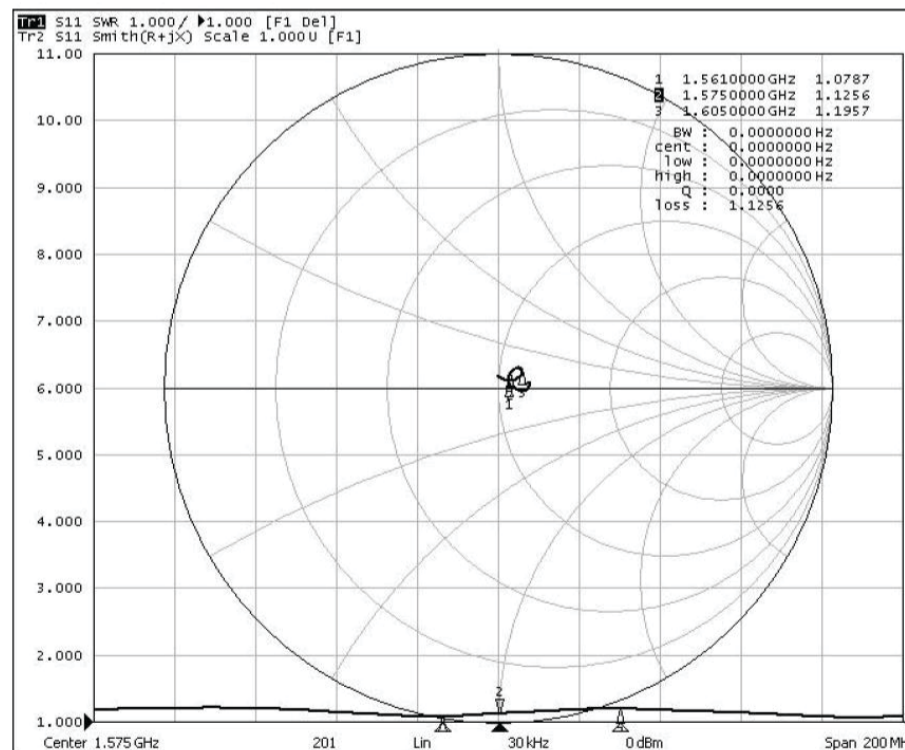
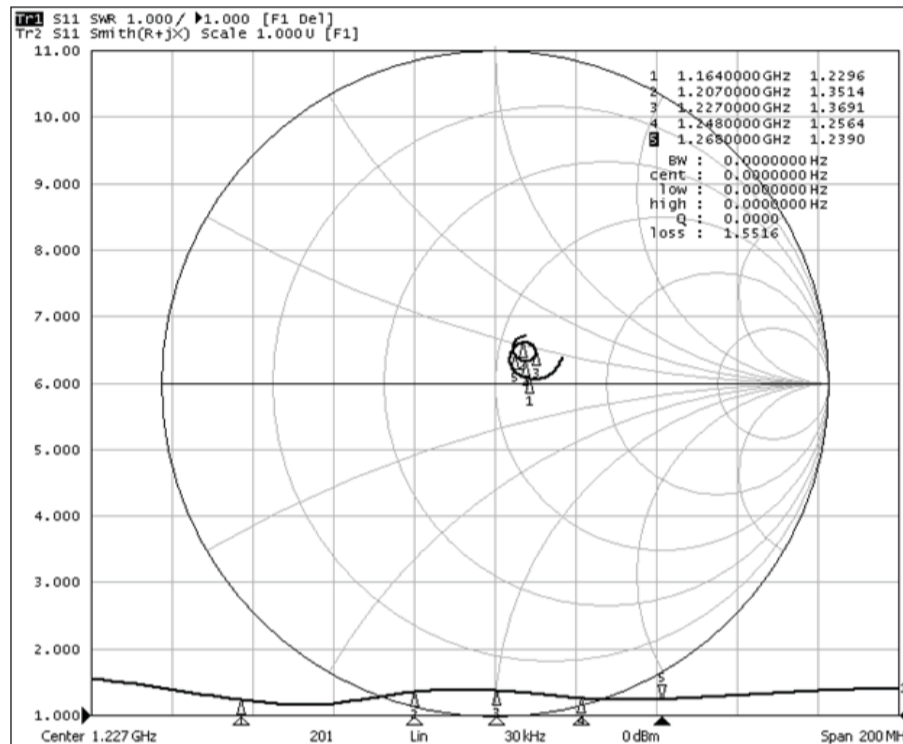

# GPS/Beidou/Glonass/Galileo/QZSS External Antenna



AEAGMK148060-S1575



ESD Sensitive



Ø148.0 x 60.0mm  
RoHS/RoHS II Compliant

MSL = NOT APPLICABLE

## RADIATION PATTERNS

Frequency, MHz	Gain, dBic	Axial Ratio
1176	2.3	1.0
1207	3.5	1.6
1227	3.5	1.8
1246	2.5	1.6
1268	1.5	1.0
1561	4.0	0.7
1575	4.5	0.8
1602	4.4	0.7

1176 MHz

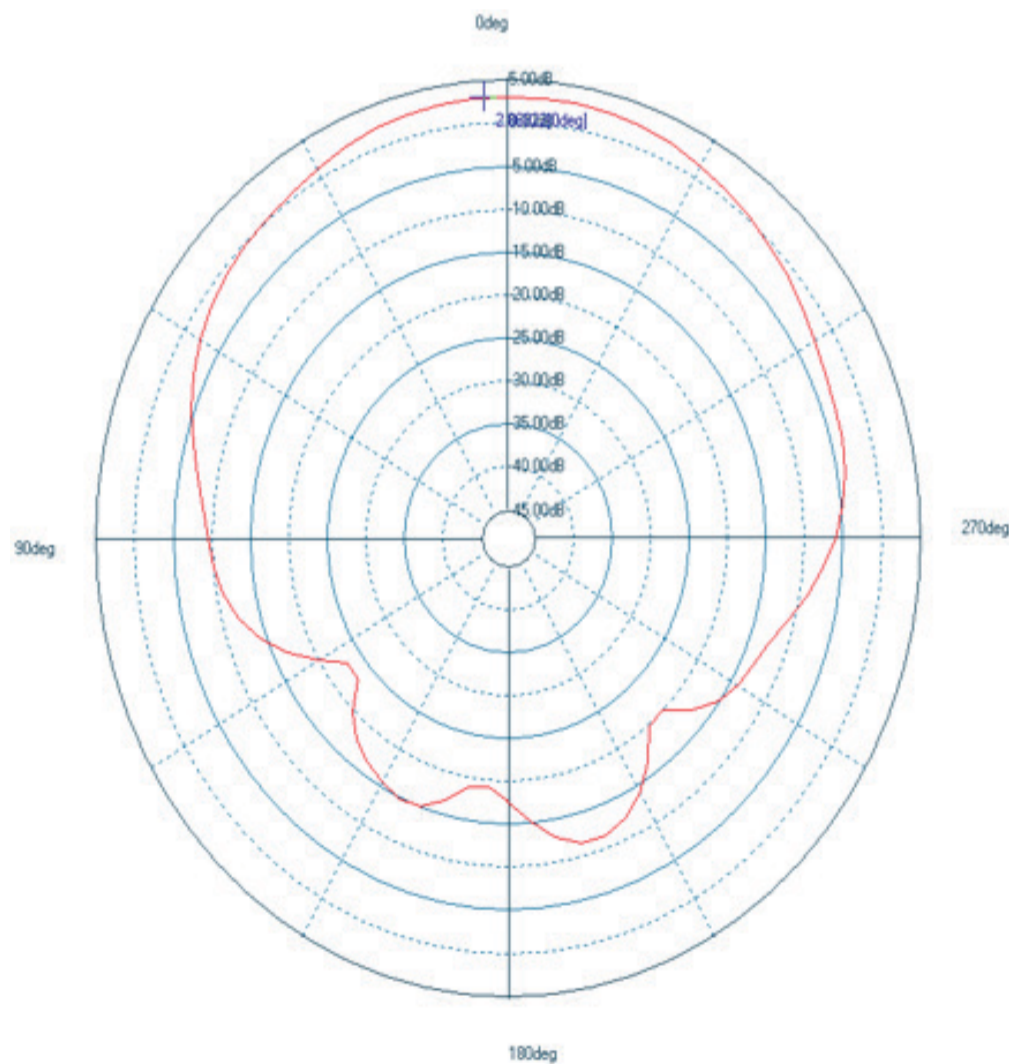

# GPS/Beidou/Glonass/Galileo/QZSS External Antenna



AEAGMK148060-S1575



ESD Sensitive



Ø148.0 x 60.0mm  
RoHS/RoHS II Compliant  
MSL = NOT APPLICABLE

## RADIATION PATTERNS

1207 MHz

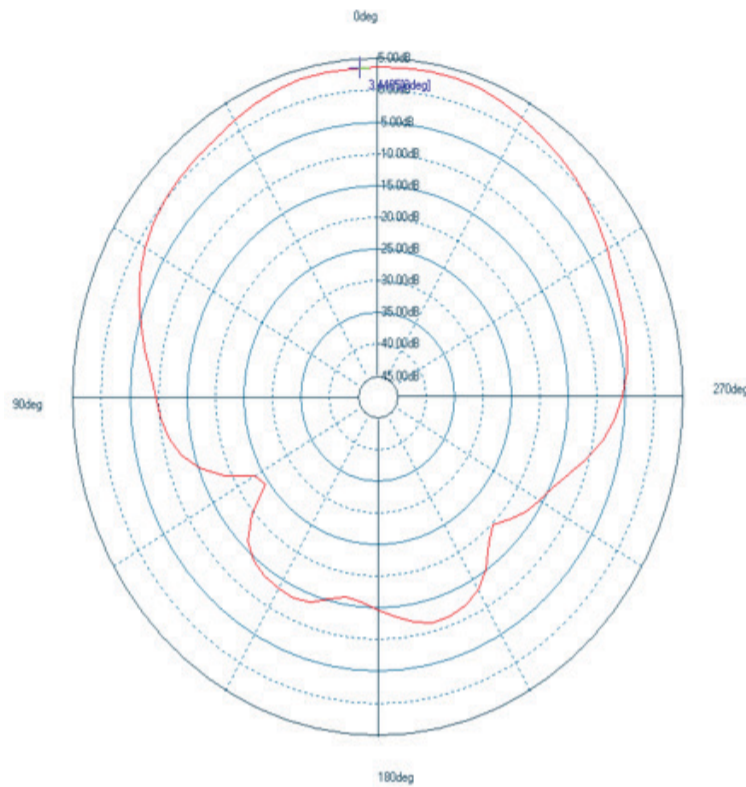

1227 MHz

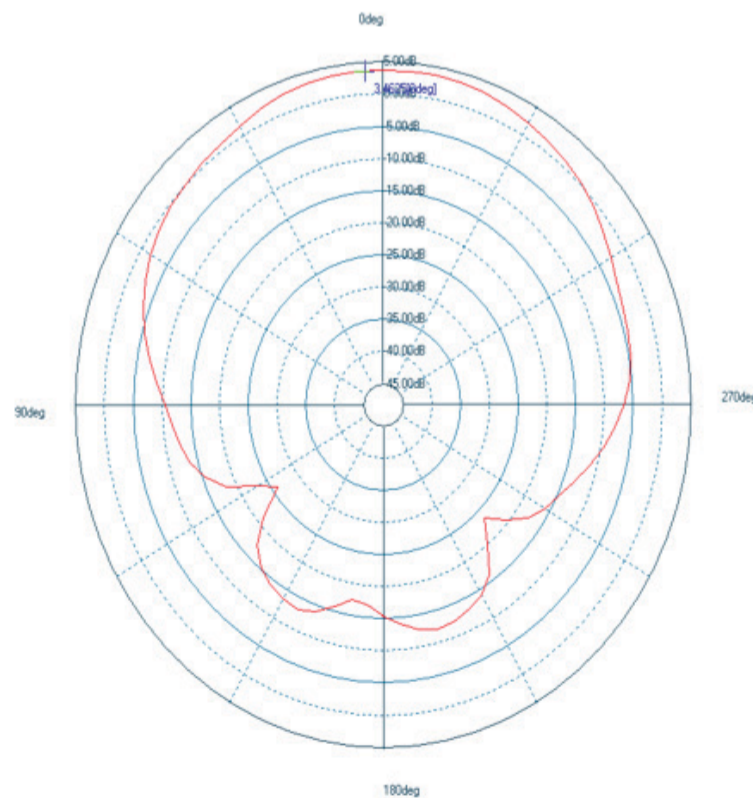

# GPS/Beidou/Glonass/Galileo/QZSS External Antenna



AEAGMK148060-S1575



ESD Sensitive



Ø148.0 x 60.0mm  
RoHS/RoHS II Compliant  
MSL = NOT APPLICABLE

## RADIATION PATTERNS

1246 MHz

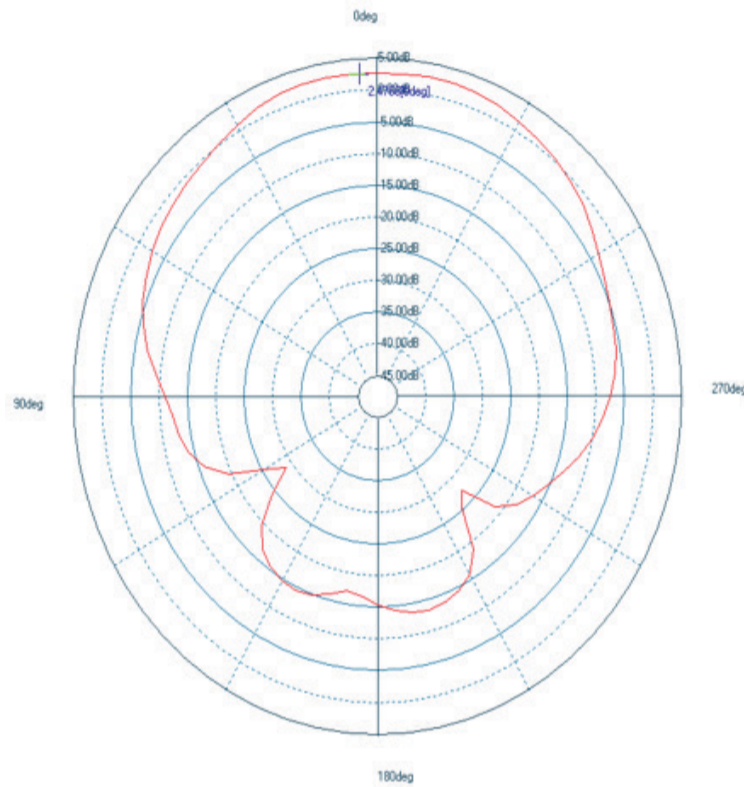

1268 MHz

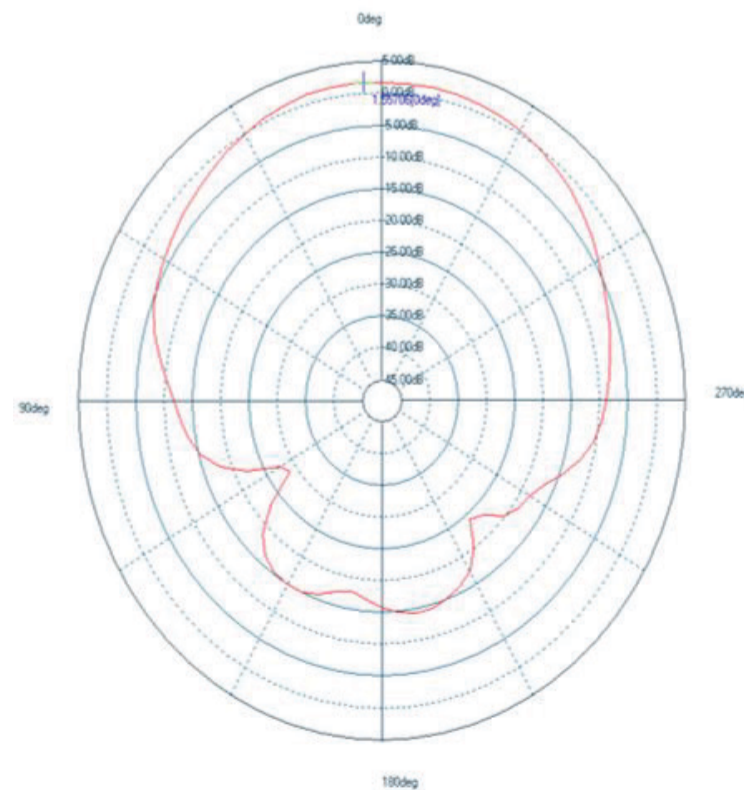

# GPS/Beidou/Glonass/Galileo/QZSS External Antenna



AEAGMK148060-S1575



ESD Sensitive



Ø148.0 x 60.0mm  
RoHS/RoHS II Compliant  
MSL = NOT APPLICABLE

## RADIATION PATTERNS

1561 MHz

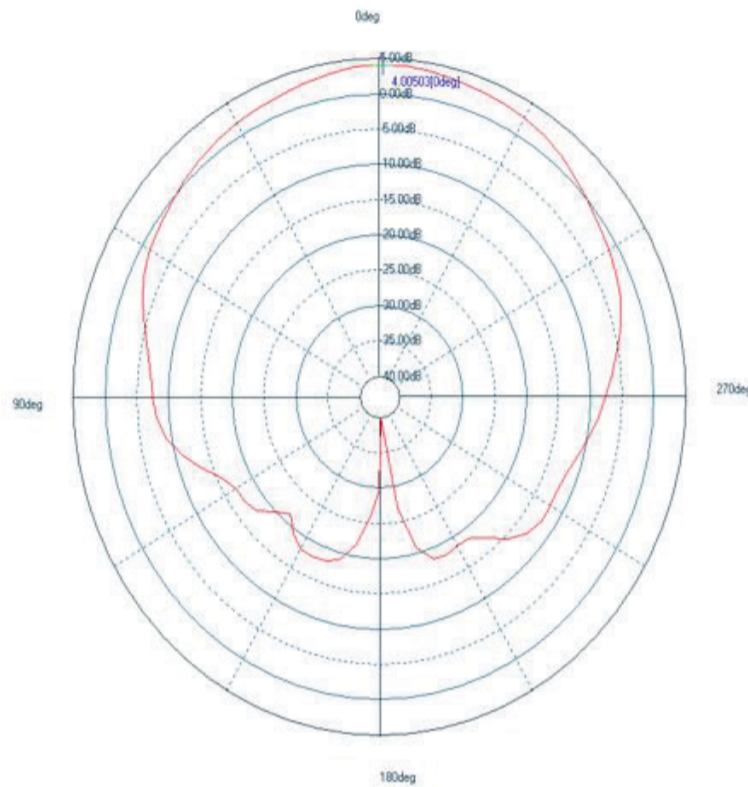

1575 MHz

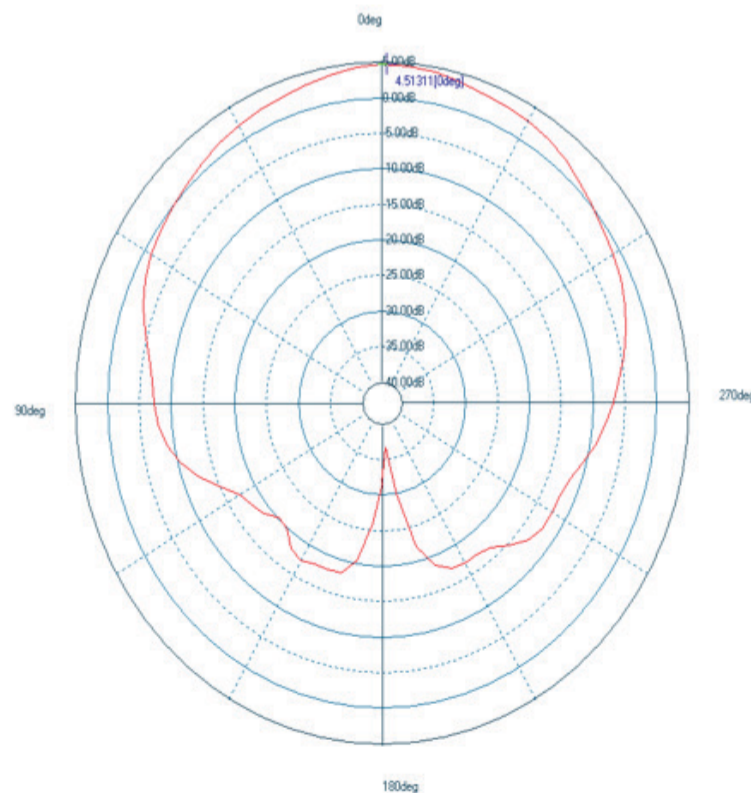

# GPS/Beidou/Glonass/Galileo/QZSS External Antenna



AEAGMK148060-S1575



ESD Sensitive



Ø148.0 x 60.0mm  
RoHS/RoHS II Compliant  
MSL = NOT APPLICABLE

## RADIATION PATTERNS

1602 MHz

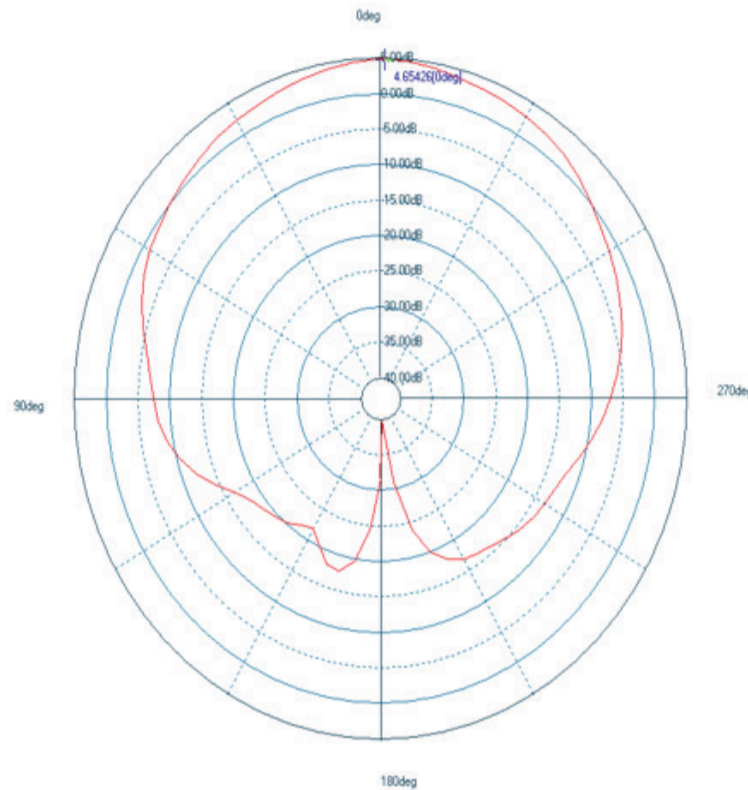



# GPS/Beidou/Glonass/Galileo/QZSS External Antenna



AEAGMK148060-S1575



ESD Sensitive



Ø148.0 x 60.0mm  
RoHS/RoHS II Compliant  
MSL = NOT APPLICABLE

## LNA TEST CURVE

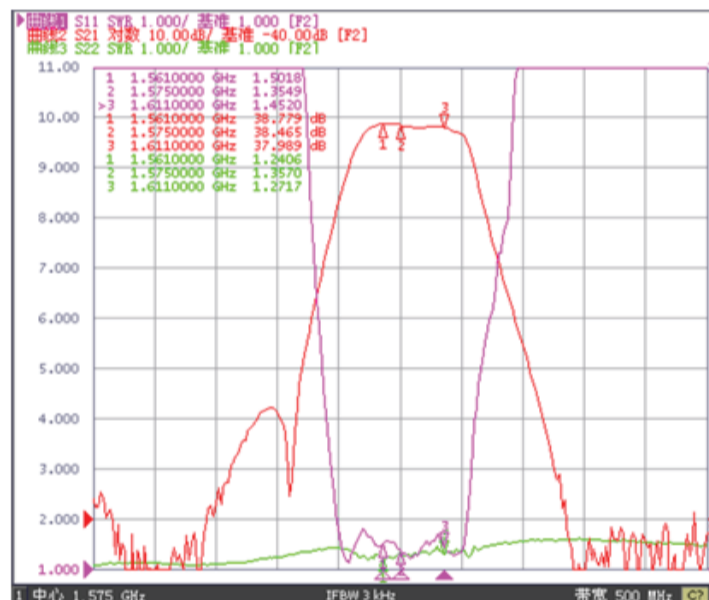
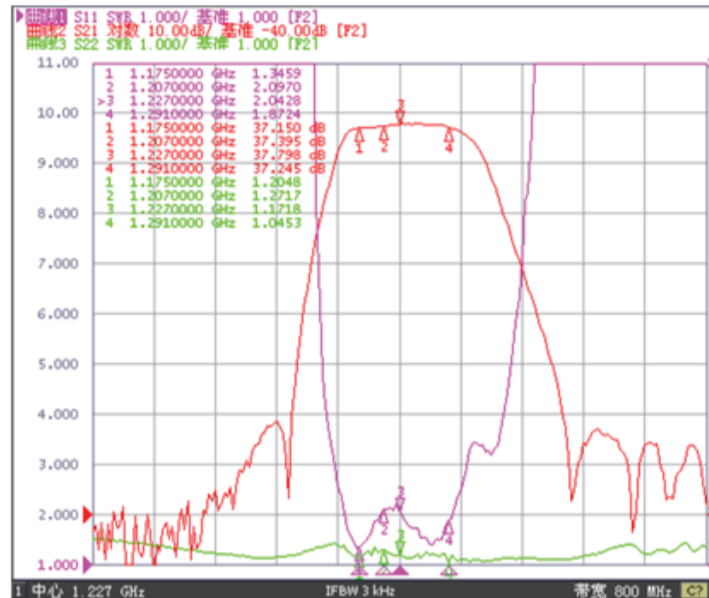

Test Condition: 3.3V DC

## PACKAGING:

Each 630 x 460 x 105 mm size carton includes 6 pcs antenna, each case 1 pcs antenna.



5101 Hidden Creek Ln Spicewood TX 78669  
Phone: 512-371-6159 | Fax: 512-351-8858  
For terms and conditions of sales, please visit:  
[www.abracon.com](http://www.abracon.com)

REVISED: 08.12.2019

ABRACON IS  
ISO9001-2015  
CERTIFIED

## X-ON Electronics

Largest Supplier of Electrical and Electronic Components

*Click to view similar products for [Antennas](#) category:*

*Click to view products by [Abracon](#) manufacturer:*

Other Similar products are found below :

[GAN30084EU](#) [930-033-R](#) [GW17.07.0250E](#) [1513563-1](#) [EXE902SM](#) [APAMPG-117](#) [MAF94383](#) [W3908B0100](#) [W6102B0100](#) [YE572113-30RSMM](#) [108-00014-50](#) [66089-2406](#) [A09-F8NF-M](#) [A09-F5NF-M](#) [RGFRA1903041A1T](#) [W3593B0100](#) [W3921B0100](#) [SIMNA-868](#) [SIMNA-915](#) [SIMNA-433](#) [W1044](#) [W1049B090](#) [A75-001](#) [WTL2449CQ1-FRSMM](#) [CPL9C](#) [EXB148BN](#) [0600-00060](#) [TRA9020S3PBN-001](#) [GD5W-28P-NF](#) [MA9-7N](#) [GD53-25](#) [GD5W-21P-NF](#) [EXB144SM](#) [C37](#) [MAF94051](#) [GD35-17P-NF](#) [P1744](#) [MA9-5N](#) [EXD420PL](#) [B1322NR](#) [QWFTB120](#) [MAF94271](#) [MAF94300](#) [GPSMB301](#) [FG4403](#) [AO-AGSM-OM54](#) [5200232](#) [MIKROE-2349](#) [WCM.01.0111](#) [MIKROE-2393](#)