

Multiband Active GNSS (GPS/GLONASS/BEIDOU) External Antenna



AEARBA048014-SG3



48.5 x 47.0 x 14.0 mm
 RoHS/RoHS II Compliant
 MSL = N/A: Not Applicable

Features

- External Multiband GNSS antenna
- GPS/GLONASS/BEIDOU support
- Active antenna with integrated LNA
- Low VSWR across bands
- SMA connector
- Adhesive mounting

Applications

- GPS/GLONASS/BeiDou applications
- IoT
- M2M
- Surveillance
- Fleet management and asset tracking
- Autonomous driving
- Telematics
- Agriculture
- Instrumentation

Electrical Specifications

Parameters	BeiDou	GPS	GLONASS	Units	Notes
Operating Frequency	1561.098 ± 2.046	1575.420 ± 1.023	1602.000 ± 8.000	MHz	
VSWR	2.0				Max.
Peak Gain	5.78	4.27	5.65	dBi	Typ.
Impedance	50			Ω	
Polarization	RHCP				

LNA

Parameters	BeiDou	GPS	GLONASS	Units	Notes
Operating Frequency	1561.098 ± 2.046	1575.420 ± 1.023	1602.000 ± 8.000	MHz	
VSWR	2.0				Max.
Gain	28			dB	Typ.
Noise Figure	1.5			dB	Typ. @ 25°C
	1.8				Max. @ 85°C
Impedance	50			Ω	
Input Voltage (DC)	1.8			V	Min.
	3.0				Typ.
	5.5				Max.

Multiband Active GNSS (GPS/GLONASS/BEIDOU) External Antenna



AEARBA048014-SG3



48.5 x 47.0 x 14.0 mm
 RoHS/RoHS II Compliant
 MSL = N/A: Not Applicable

System Set-up

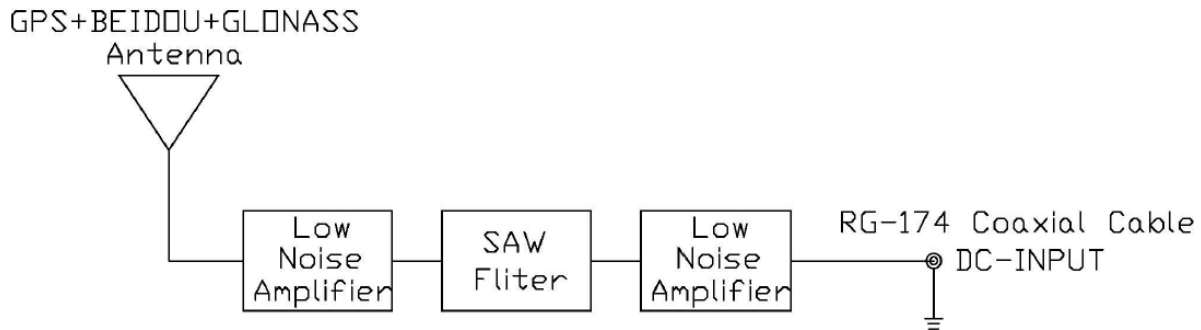

Parameters	BeiDou	GPS	GLONASS	Units	Notes
Operating Frequency	1561.098 ± 2.046	1575.420 ± 1.023	1602.000 ± 8.000	MHz	
VSWR	2.0				Max.
Gain	28			dBic	@Zenith - Cable Loss (@ 3.0 V DC input)
Input Voltage (DC)	1.8			V	Min.
	3.0				Typ.
	5.5				Max.
Impedance	50			Ω	
Cable Loss	-1.4			dB/m	Max.

Mechanical Specification

Parameters	Description	Notes
RF Cable	Ø2.7 ± 0.2 mm	Color : Black
Cable Length (L)	5 ± 0.05 m	
RF Connector	SMA - M	
Mounting Type	Adhesive	

Environmental Specification

Parameters	Description
Operating Temperature	-40°C to +85°C
Storage Temperature	-40°C to +105°C
Relative Humidity	40% to 95%

Multiband Active GNSS (GPS/GLONASS/BEIDOU) External Antenna



AEARBA048014-SG3



48.5 x 47.0 x 14.0 mm
RoHS/RoHS II Compliant
MSL = N/A: Not Applicable

Product Dimensions

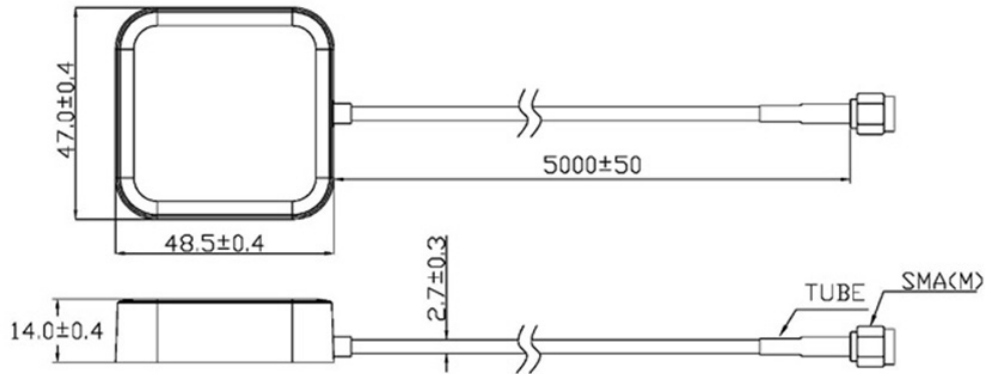

Unit : mm

With Adhesive Tape :

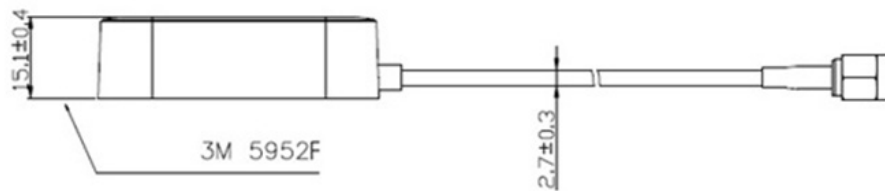

Unit : mm



AEARBA048014-SG3



48.5 x 47.0 x 14.0 mm
 RoHS/RoHS II Compliant
 MSL = N/A: Not Applicable

Return Loss and Impedance Characteristics

Frequency (MHz)	Return Loss (dB)	Impedance (Ω)	VSWR
1561	-36.58	52.73 - j02.00	1.06
1575	-18.77	44.64 + j06.58	1.24
1602	-16.98	43.96 - j38.40	1.25

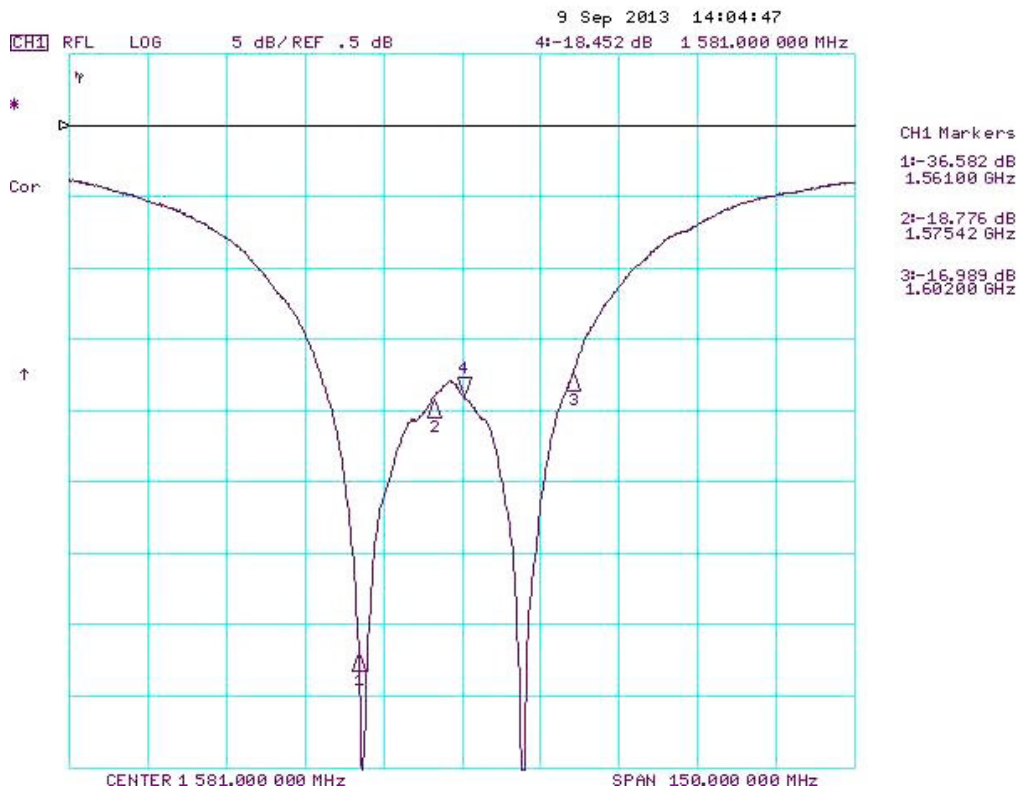



AEARBA048014-SG3



48.5 x 47.0 x 14.0 mm
RoHS/RoHS II Compliant
MSL = N/A: Not Applicable

Return Loss and Impedance Characteristics

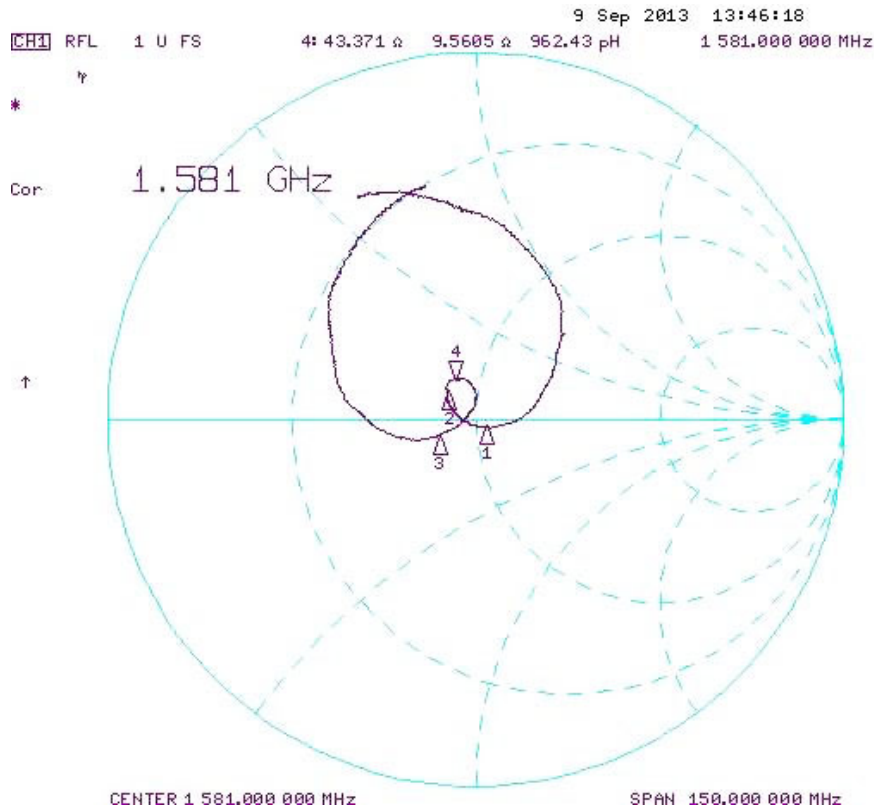

CH1 Markers

1: 52.734 Ω
-2.0059 Ω
1.56100 GHz

2: 42.428 Ω
6.5881 Ω
1.57542 GHz

3: 40.545 Ω
-3.8418 Ω
1.60200 GHz



AEARBA048014-SG3



48.5 x 47.0 x 14.0 mm
RoHS/RoHS II Compliant
MSL = N/A: Not Applicable

Radiation Pattern

XZ - Plane

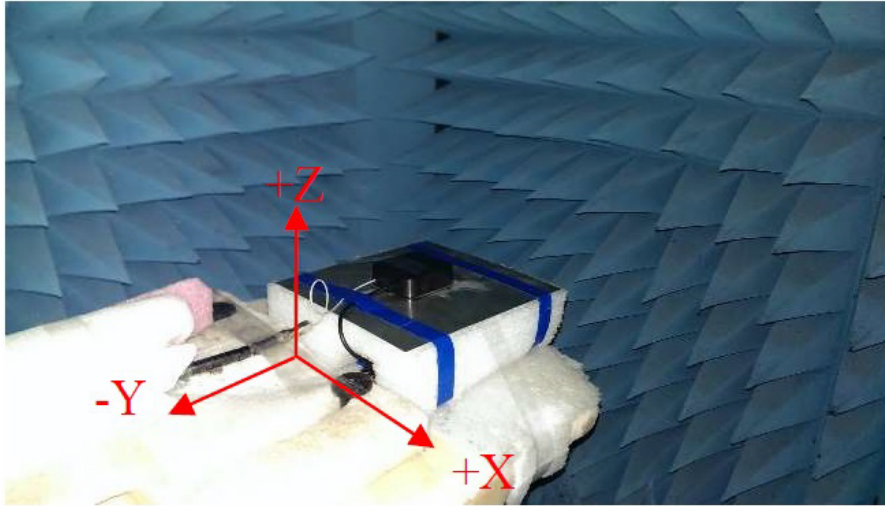

YZ - Plane

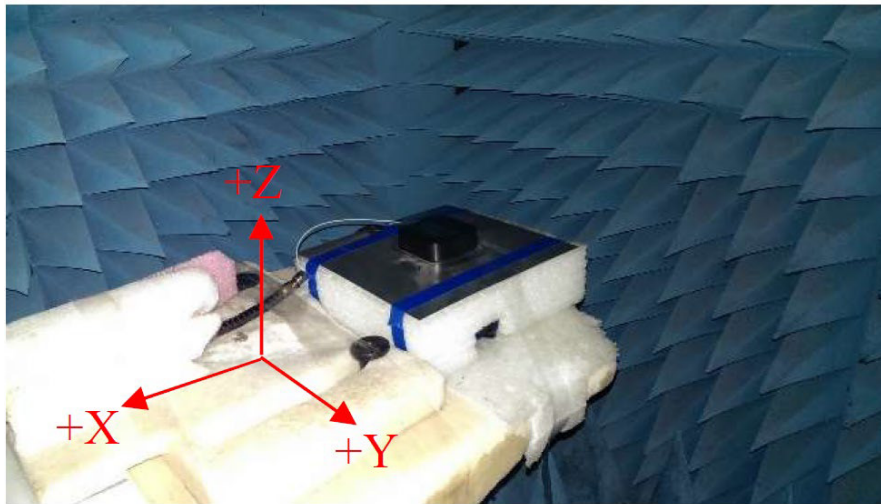

Multiband Active GNSS (GPS/GLONASS/BEIDOU) External Antenna



AEARBA048014-SG3



48.5 x 47.0 x 14.0 mm
RoHS/RoHS II Compliant
MSL = N/A: Not Applicable

Radiation Pattern

BeiDou : 1561 MHz

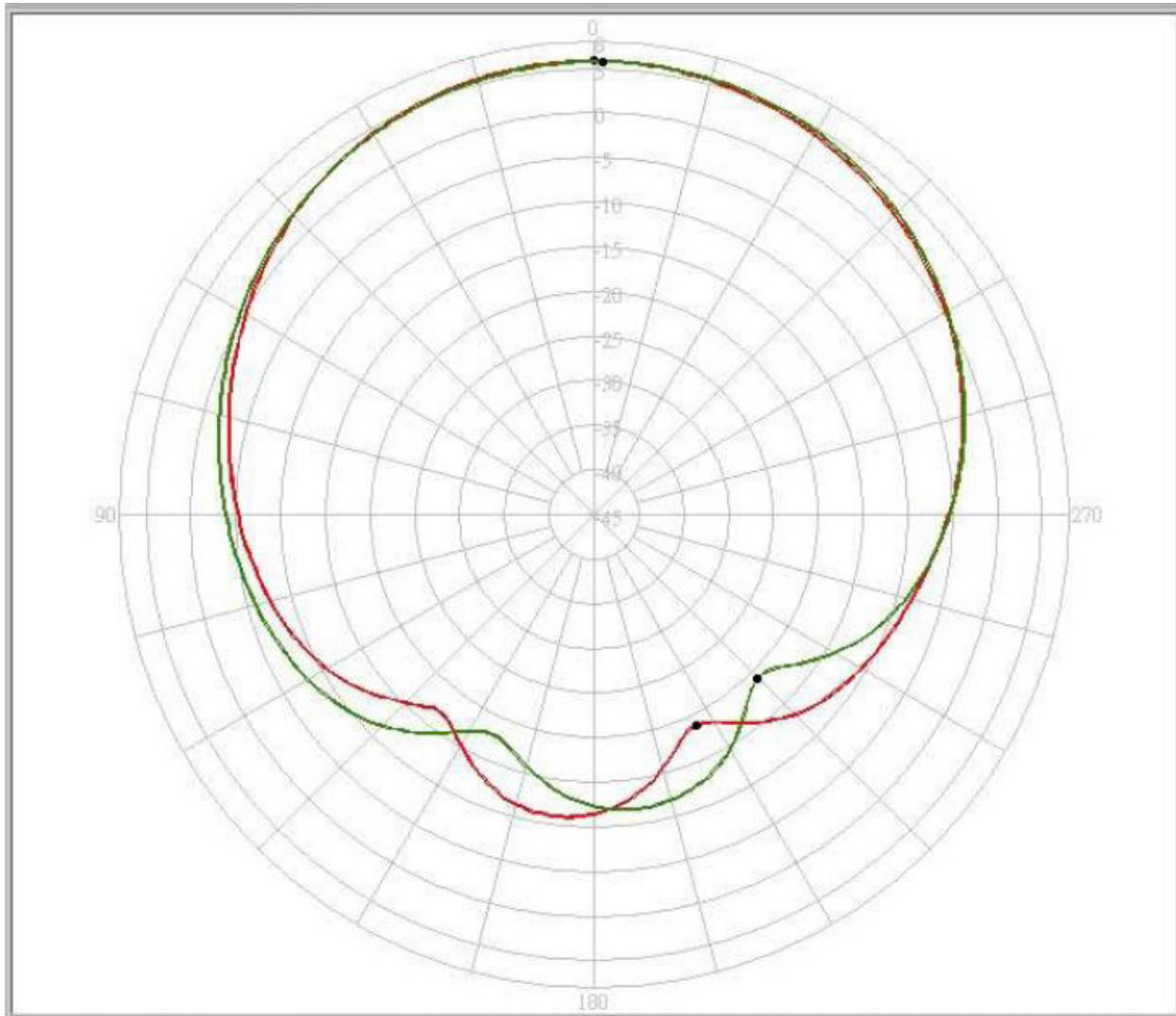

1561 MHz	Peak Gain (dBi)	Zenith Gain (dBi)
XZ	5.81	5.81
YZ	5.78	5.78

Multiband Active GNSS (GPS/GLONASS/BEIDOU) External Antenna



AEARBA048014-SG3



48.5 x 47.0 x 14.0 mm
 RoHS/RoHS II Compliant
 MSL = N/A: Not Applicable

Radiation Pattern

GPS : 1575.42 MHz

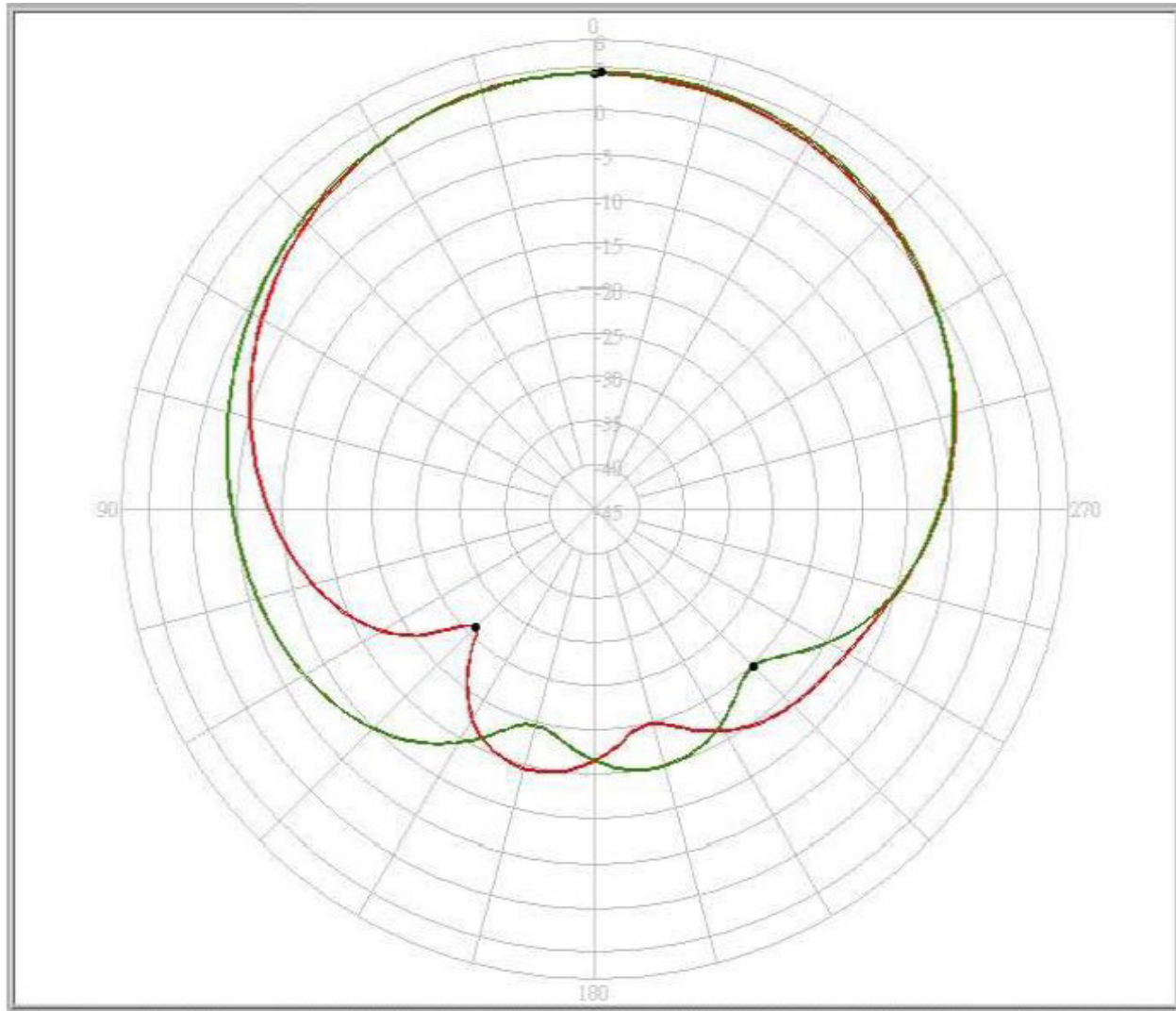

1561 MHz	Peak Gain (dBi)	Zenith Gain (dBi)
XZ	4.18	4.18
YZ	4.27	4.18

Multiband Active GNSS (GPS/GLONASS/BEIDOU) External Antenna



AEARBA048014-SG3



48.5 x 47.0 x 14.0 mm
RoHS/RoHS II Compliant
MSL = N/A: Not Applicable

Radiation Pattern

GLONASS : 1602 MHz

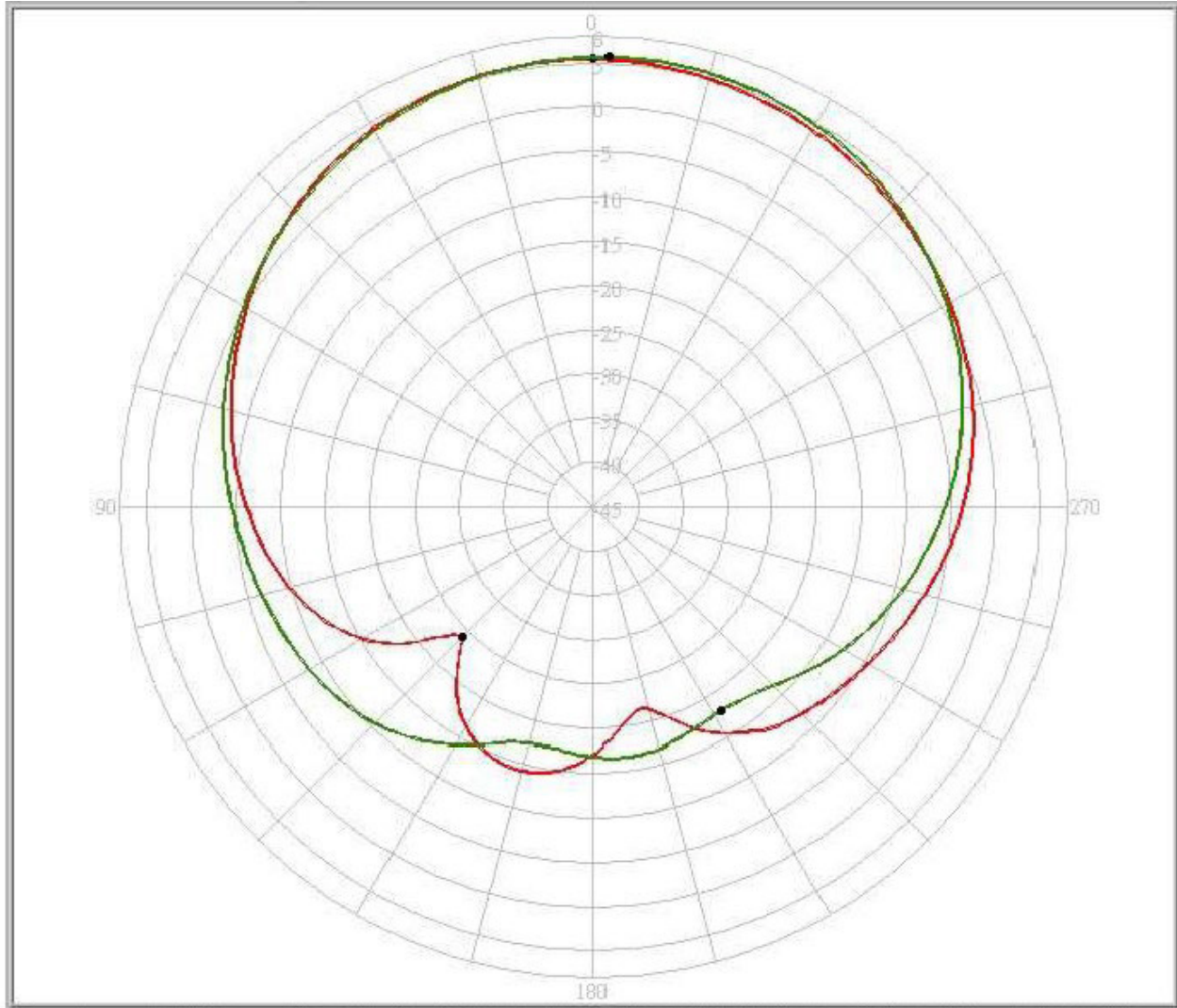

1561 MHz	Peak Gain (dBi)	Zenith Gain (dBi)
XZ	5.40	5.40
YZ	5.65	5.40



AEARBA048014-SG3



48.5 x 47.0 x 14.0 mm
RoHS/RoHS II Compliant
MSL = N/A: Not Applicable

Radiation Pattern - 3D Pattern

BeiDou : 1561 MHz

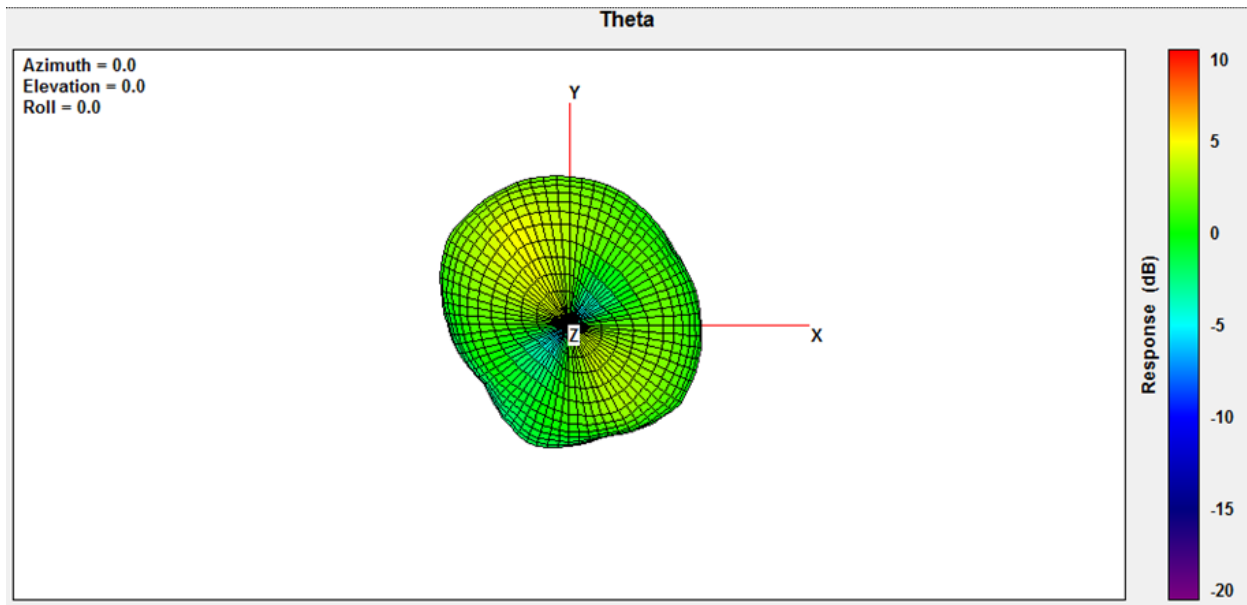

GPS : 1575.42 MHz

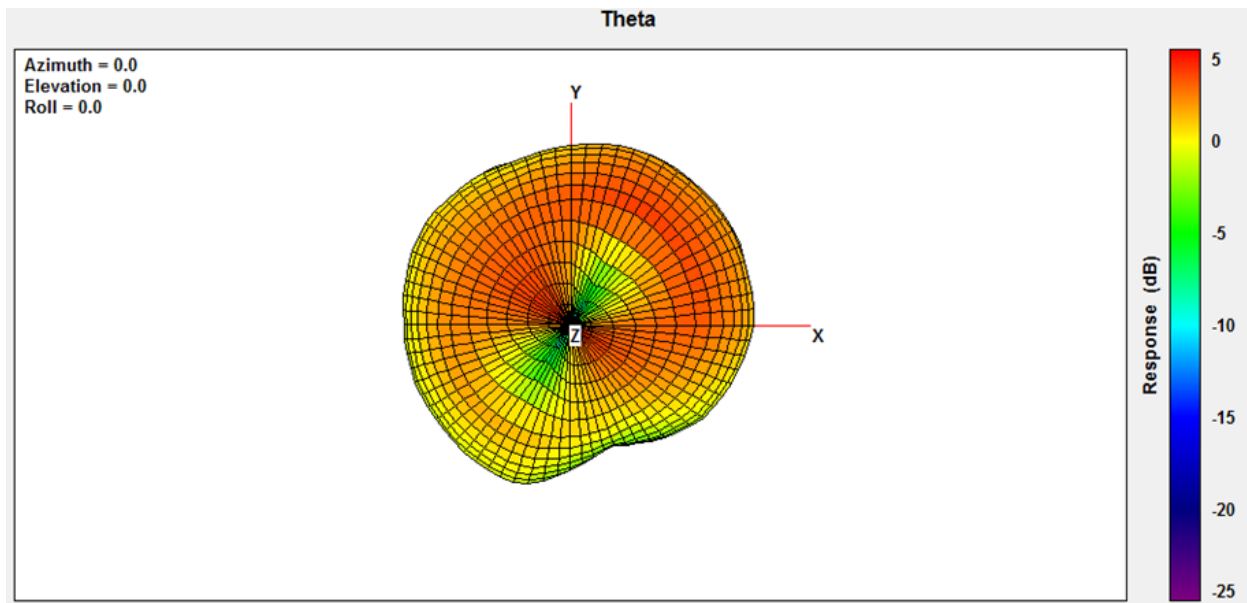

Multiband Active GNSS (GPS/GLONASS/BEIDOU) External Antenna



AEARBA048014-SG3



48.5 x 47.0 x 14.0 mm
RoHS/RoHS II Compliant
MSL = N/A: Not Applicable

Radiation Pattern - 3D Pattern

GLONASS : 1602 MHz

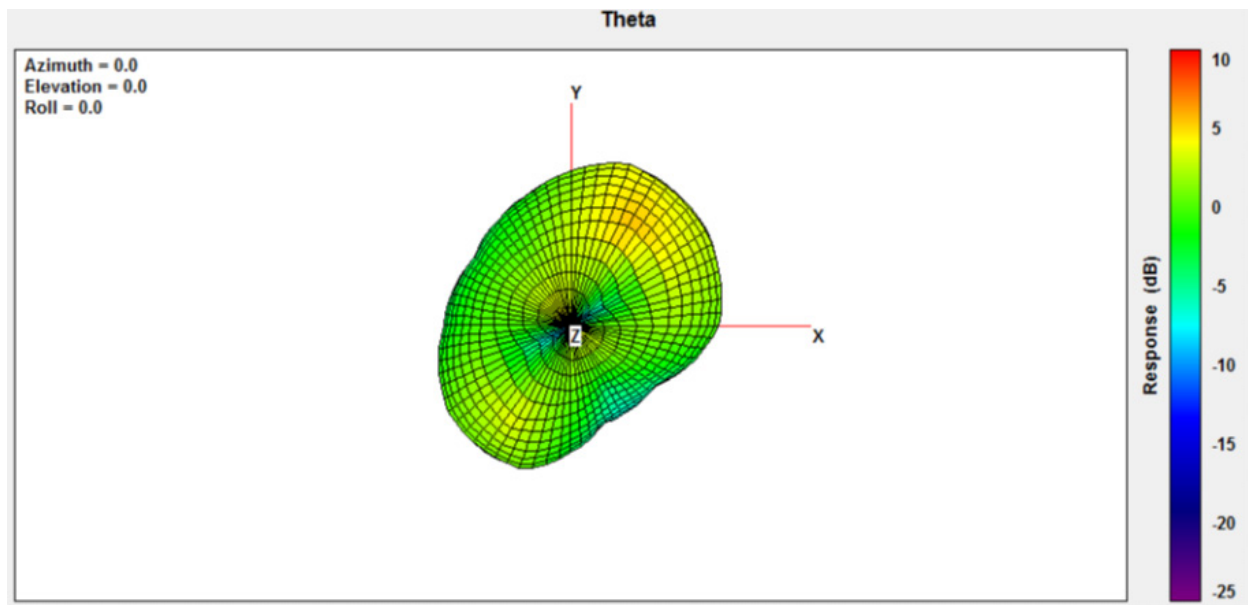

Packaging

Each carton is of dimension 370 x 370 x 300 mm with 100 units.

ATTENTION: Abracon LLC's products are COTS – Commercial-Off-The-Shelf products; suitable for Commercial, Industrial and, where designated, Automotive Applications. Abracon's products are not specifically designed for Military, Aviation, Aerospace, Life-dependent Medical applications or any application requiring high reliability where component failure could result in loss of life and/or property. For applications requiring high reliability and/or presenting an extreme operating environment, written consent and authorization from Abracon LLC is required. Please contact Abracon LLC for more information.



5101 Hidden Creek Ln Spicewood TX 78669
Phone: 512-371-6159 | Fax: 512-351-8858
For terms and conditions of sales, please visit:
www.abracon.com

REVISED: 06-13-19

ABRACON IS
ISO9001-2015
CERTIFIED

X-ON Electronics

Largest Supplier of Electrical and Electronic Components

Click to view similar products for [Antennas](#) category:

Click to view products by [Abracon](#) manufacturer:

Other Similar products are found below :

[GAN30084EU](#) [930-033-R](#) [GW17.07.0250E](#) [1513563-1](#) [EXE902SM](#) [APAMPG-117](#) [MAF94383](#) [W3908B0100](#) [W6102B0100](#) [YE572113-30RSMM](#) [108-00014-50](#) [66089-2406](#) [A09-F8NF-M](#) [A09-F5NF-M](#) [RGFRA1903041A1T](#) [W3593B0100](#) [W3921B0100](#) [SIMNA-868](#) [SIMNA-915](#) [SIMNA-433](#) [W1044](#) [W1049B090](#) [A75-001](#) [WTL2449CQ1-FRSMM](#) [CPL9C](#) [EXB148BN](#) [0600-00060](#) [TRA9020S3PBN-001](#) [GD5W-28P-NF](#) [MA9-7N](#) [GD53-25](#) [GD5W-21P-NF](#) [EXB144SM](#) [C37](#) [MAF94051](#) [GD35-17P-NF](#) [P1744](#) [MA9-5N](#) [EXD420PL](#) [B1322NR](#) [QWFTB120](#) [MAF94271](#) [MAF94300](#) [GPSMB301](#) [FG4403](#) [AO-AGSM-OM54](#) [5200232](#) [MIKROE-2349](#) [WCM.01.0111](#) [MIKROE-2393](#)