

# Automotive Ferrite Chip Beads

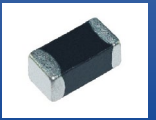

AFBC-Q0805H

Request Samples



Check Inventory



2.00 x 1.25 x 0.85 mm  
RoHS/RoHS II Compliant  
MSL Level = 1

## Features

- AEC-Q200 Qualified
- Operating Temperature: -55 ~ +150°C
- Wide range impedance
- Monolithic inorganic material construction
- Excellent heat resistance

## Applications

- Electronic control Units (ECUs)
- RF transceiver modules
- Antennas
- Infotainment system
- ADAS
- Industrial connectivity (IIoT)

## Electrical Specifications

Part Number	Impedance	DC Resistance	Rated Current
Units	$\Omega \pm 25\%$	$\Omega$ Max.	mA Max.
Symbol	Z	R <sub>DC</sub>	I <sub>R</sub>
AFBC-Q0805H-300	30	0.04	3000
AFBC-Q0805H-800	80	0.04	3000
AFBC-Q0805H-121	120	0.10	2000
AFBC-Q0805H-151	150	0.10	2000
AFBC-Q0805H-221	220	0.10	2000
AFBC-Q0805H-301	300	0.2	1000
AFBC-Q0805H-471	470	0.2	1000
AFBC-Q0805H-601	600	0.2	1000

## Test Conditions and Equipment

Impedance Test Frequency: 100MHz

I<sub>R</sub>: Temperature Rise: 40°C Max. At Rated Current  $\geq 1A$ .

**Operating Temperature:** -55°C to +150°C (Including Self-Temperature rise)

**Storage Temperature:** <+40°C and RH 60% (Max).

AFBC-Q0805H is **RoHS Compliant and Pb free**

# Automotive Ferrite Chip Beads



**AFBC-Q0805H**

Request Samples



Check Inventory



**2.00 x 1.25 x 0.85 mm**  
**RoHS/RoHS II Compliant**  
**MSL Level = 1**

## Electrical Specifications (Cont'd)

AFBC-Q0805H-300

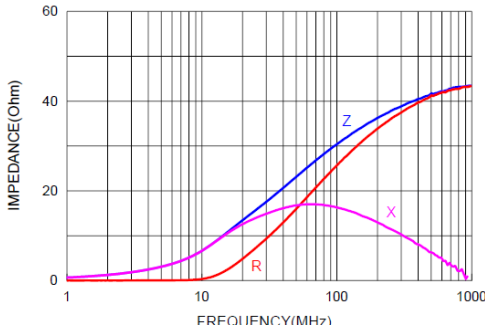

AFBC-Q0805H-800

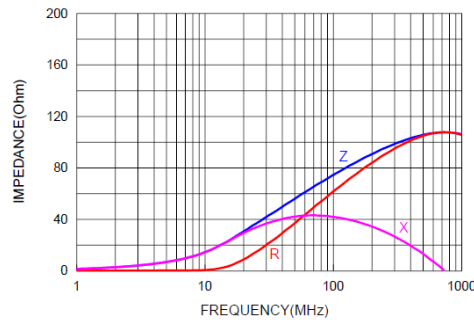

AFBC-Q0805H-121

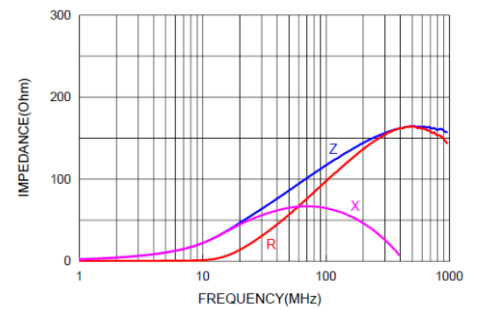

AFBC-Q0805H-151

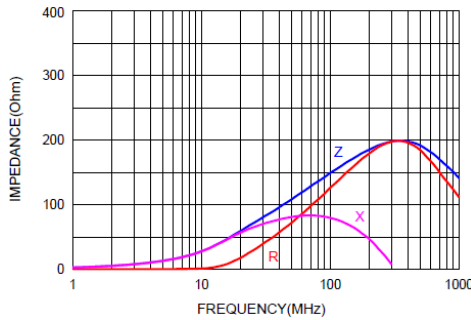

AFBC-Q0805H-221

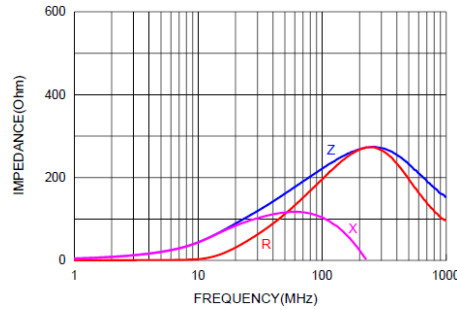

AFBC-Q0805H-301

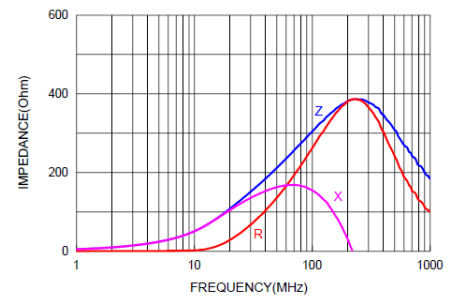

AFBC-Q0805H-471

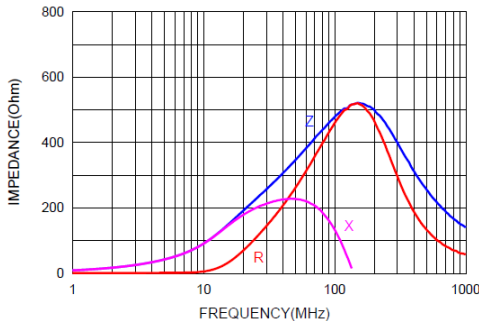

AFBC-Q0805H-601

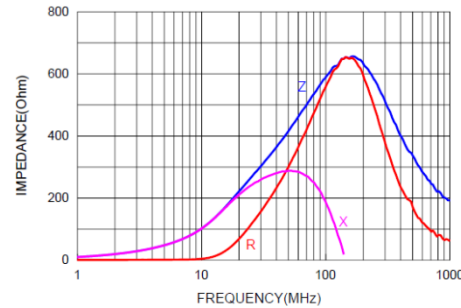

5101 Hidden Creek Ln Spicewood TX 78669  
 Phone: 512-371-6159 | Fax: 512-351-8858  
 For terms and conditions of sales, please visit:  
[www.abracon.com](http://www.abracon.com)

REVISION: IR 08-10-22

ABRACON IS  
 ISO9001-2015  
 CERTIFIED

# Automotive Ferrite Chip Beads

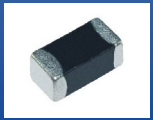

**AFBC-Q0805H**

Request Samples



Check Inventory



2.00 x 1.25 x 0.85 mm  
**RoHS/RoHS II Compliant**  
 MSL Level = 1

## Part Number Identification

AFBC -Q0805H -  -

**Impedance Code**  
 Please refer to the  
 Electrical Specification  
 table

**Packaging**  
 T: Tape and Reel  
 (4kpcs / reel)

## Mechanical Specifications

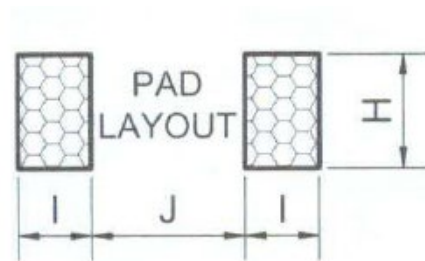
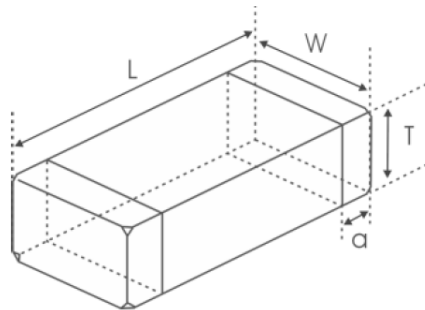

L	W	T	a	H	I	J
2.00±0.2	1.25±0.2	0.85±0.2	0.50±0.30	1.45 Ref.	1.05 Ref.	1.00 Ref.

Dimension: mm

# Automotive Ferrite Chip Beads



AFBC-Q0805H

Request Samples



Check Inventory



2.00 x 1.25 x 0.85 mm  
 RoHS/RoHS II Compliant  
 MSL Level = 1

## Materials

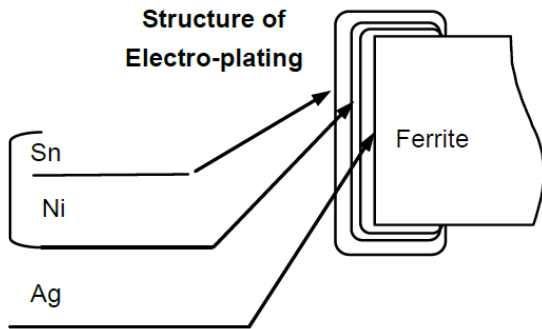

	Structure Description
1	Ferrite for Beads
2	Internal Terminal Electrode: Ag (100%)
3	Electro-plating: Ni (100%)
4	External Electro-plating: Sn (100%)

## Reflow Profile

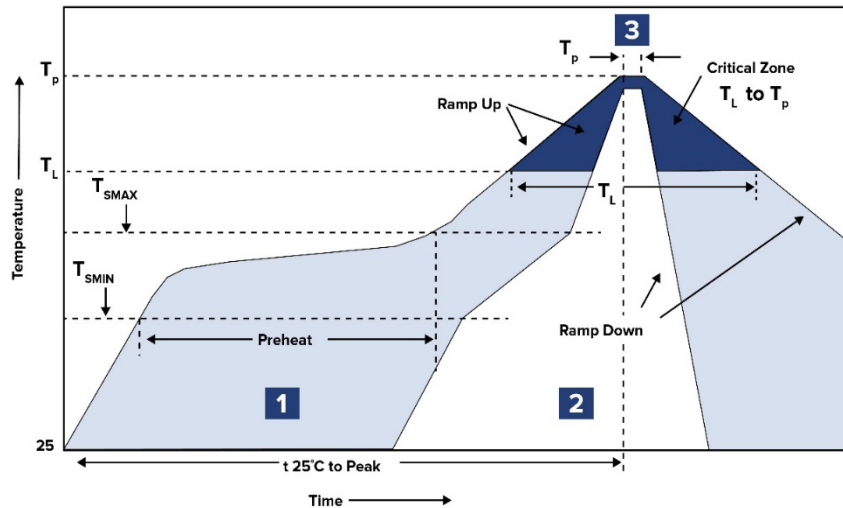

Zone	Description	Temperature	Times
1	Preheat	$T_{SMIN} \sim T_{SMAX}$ 150°C ~ 200°C	60 ~ 180 sec.
2	Reflow	$T_L$ 245°C	20 ~ 40 sec.
3	Peak heat	$T_P$ 260°C	10 sec. MAX

# Automotive Ferrite Chip Beads



**AFBC-Q0805H**

Request Samples



Check Inventory



**2.00 x 1.25 x 0.85 mm**  
**RoHS/RoHS II Compliant**  
**MSL Level = 1**

## Packaging

**T= Tape and reel (4,000 pcs/reel)**

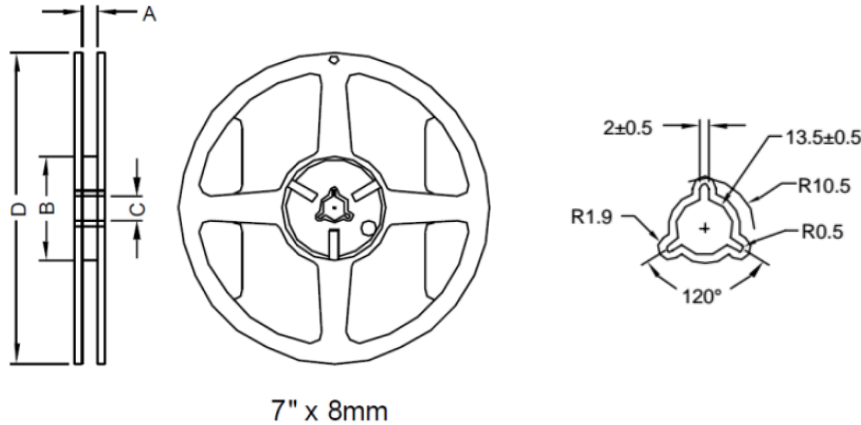

Type	A	B	C	D
7"x8mm	9.0 ± 0.5	60.0 ± 2.0	13.5 ± 0.5	178.0 ± 2.0

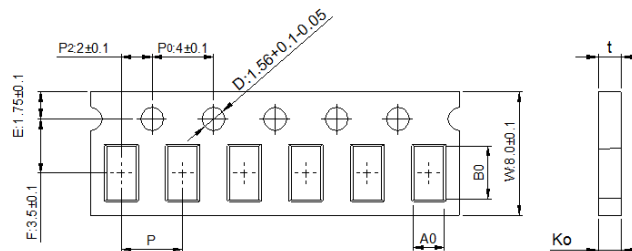

Series	Bo	Ao	Ko	P
AFBC-Q0805H	2.10 ± 0.05	1.30 ± 0.05	0.95 ± 0.05	4.00 ± 0.10

**Dimension: mm**

**ATTENTION:** Abracon LLC's products are COTS – Commercial-Off-The-Shelf products; suitable for Commercial, Industrial and, where designated, Automotive Applications. Abracon's products are not specifically designed for Military, Aviation, Aerospace, Life-dependent Medical applications or any application requiring high reliability where component failure could result in loss of life and/or property. For applications requiring high reliability and/or presenting an extreme operating environment, written consent and authorization from Abracon LLC is required. Please contact Abracon LLC for more information.



5101 Hidden Creek Ln Spicewood TX 78669  
 Phone: 512-371-6159 | Fax: 512-351-8858  
 For terms and conditions of sales, please visit:  
[www.abracon.com](http://www.abracon.com)

**REVISION: IR 08-10-22**

ABRACON IS  
 ISO9001-2015  
 CERTIFIED

## X-ON Electronics

Largest Supplier of Electrical and Electronic Components

*Click to view similar products for [Ferrite Beads](#) category:*

*Click to view products by [Abracon](#) manufacturer:*

Other Similar products are found below :

[CZB1EGTTP700P](#) [CZB1JGTTD152P](#) [CZB2AFTTD800P](#) [CZB2AGTTD121P](#) [PE-0402FB121ST](#) [AB 3X2X3SM](#) [DER0705-2.2](#)  
[NCB0603R301TR050F](#) [NCB0805A320TR050F](#) [NCB-H1206B680TR300F](#) [CZB1JGTTD221P](#) [CZB1JGTTD600P](#) [CZB2AGTTD301P](#)  
[CZB2BFTTE301P](#) [CZB2BFTTE601P](#) [4221R-1](#) [EMI0805R-600](#) [SBY100505T-100Y-N](#) [NCB-GH0402D121TR060F](#) [NCB0402P301TR005F](#)  
[NCB0603R152TR030F](#) [NCB0805A121TR050F](#) [NCB0805A301TR070F](#) [NCB3312K900TR500F](#) [NCB-H0805A221TR300F](#)  
[NCB0402P221TR030F](#) [NCB0805A102TR040F](#) [NCB1806E151TR020F](#) [NCB-H0402P100TR200F](#) [NCB-H0603R121TR300F](#) [NCB-](#)  
[H0805A220TR600F](#) [NCB-H0805A390TR400F](#) [NCB-H1206B601TR200F](#) [CZB1JGTTD202P](#) [CBH160808W221T](#) [WLBD1005HCU330TL](#)  
[WLBD2012HCU121TH](#) [WLBD2012HCU221TH](#) [WQBD1608HCU121TH](#) [WLBD1608K2U252TB](#) [VLU0810-102KBC12](#)  
[WLBD1608K2U800TP](#) [BMB2A0080AN4](#) [SZ1608F470TF](#) [FBSHC0805-331-302R](#) [HFJ100505T-601Y-N](#) [HFY100505T-221Y-N](#)  
[PBY201209T-110Y-N](#) [SBY060303T-121Y-N](#) [SBY100505T-750Y-N](#)