

Automotive Ferrite Chip Beads

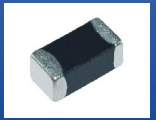

AFBC-Q3211

Request Samples



Check Inventory



3.20 x 1.60 x 1.10 mm
RoHS/RoHS II Compliant
MSL Level = 1

Features

- AEC-Q200 Qualified
- Operating Temperature: -55 ~ +150°C
- Wide range impedance
- Monolithic inorganic material construction
- Excellent heat resistance
- Current rating up to 3A

Applications

- Electronic control Units (ECUs)
- Battery Management Systems (BMS)
- Powertrain system
- DC/AC Converters
- Industrial connectivity (IIoT)

Electrical Specifications

Part Number	Impedance	DC Resistance	Rated Current
Units	$\Omega \pm 25\%$	Ω Max.	mA Max.
Symbol	Z	R _{DC}	I _R
AFBC-Q3211-300-T	30	0.04	3000
AFBC-Q3211-500-T	50	0.04	3000
AFBC-Q3211-800-T	80	0.04	3000
AFBC-Q3211-121-T	120	0.10	2000
AFBC-Q3211-151-T	150	0.10	2000
AFBC-Q3211-301-T	300	0.20	1000
AFBC-Q3211-471-T	470	0.20	1000
AFBC-Q3211-501-T	500	0.04	3000
AFBC-Q3211-601-T	600	0.10	2000

Test Conditions and Equipment

Impedance Test Frequency: 100MHz

I_R: Temperature Rise: 40°C Max. At Rated Current $\geq 1A$.

Operating Temperature: -55°C to +150°C (Including Self-Temperature rise)

Storage Temperature: <+40°C and RH 60% (Max).

AFBC-Q3211 is RoHS Compliant and Pb free

Automotive Ferrite Chip Beads



AFBC-Q3211

Request Samples



Check Inventory



3.20 x 1.60 x 1.10 mm
RoHS/RoHS II Compliant
MSL Level = 1

Electrical Specifications (Cont'd)

AFBC-Q3211-300

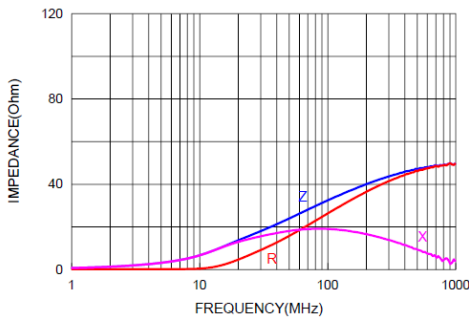

AFBC-Q3211-500

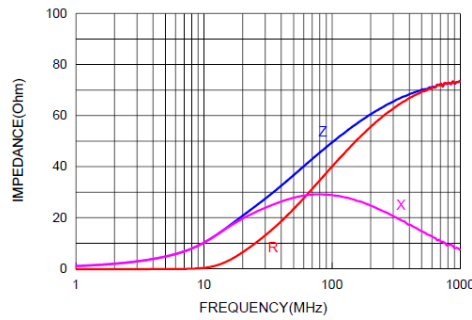

AFBC-Q3211-800

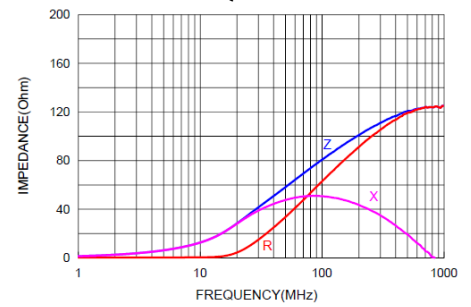

AFBC-Q3211-121

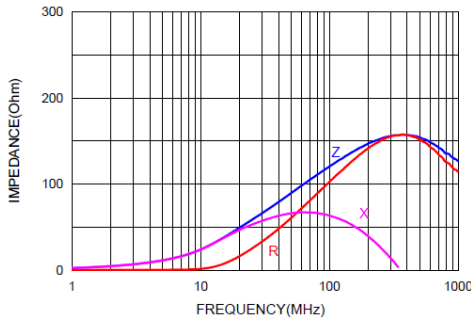

AFBC-Q3211-151

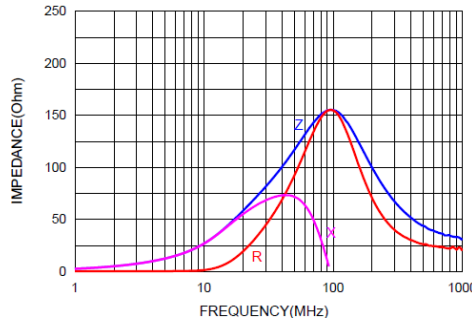

AFBC-Q3211-301

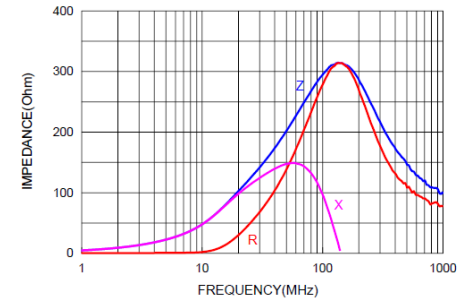

AFBC-Q3211-471

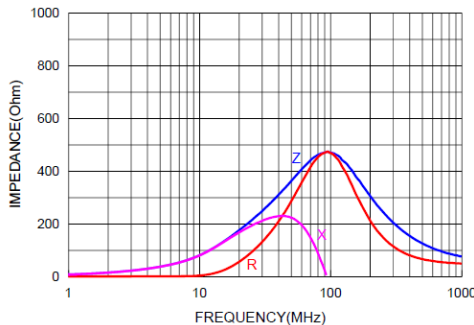

AFBC-Q3211-501

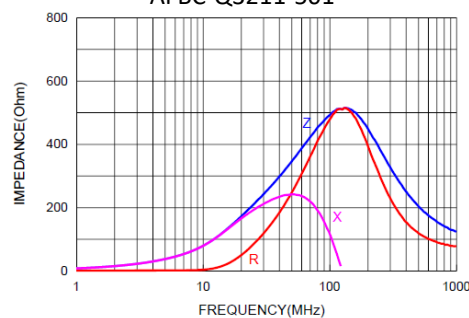

AFBC-Q3211-601

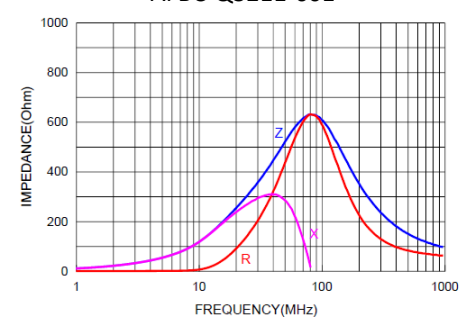

5101 Hidden Creek Ln Spicewood TX 78669
 Phone: 512-371-6159 | Fax: 512-351-8858
 For terms and conditions of sales, please visit:
www.abracon.com

REVISION: IR 08-10-22

ABRACON IS
 ISO9001-2015
 CERTIFIED

Automotive Ferrite Chip Beads



AFBC-Q3211

Request Samples



Check Inventory



3.20 x 1.60 x 1.10 mm
RoHS/RoHS II Compliant
MSL Level = 1

Part Number Identification

AFBC - Q3211 - -

Impedance Code
 Please refer to the Electrical Specification table

Packaging
 T: Tape and Reel
 (3kpcs / reel)

Mechanical Specifications

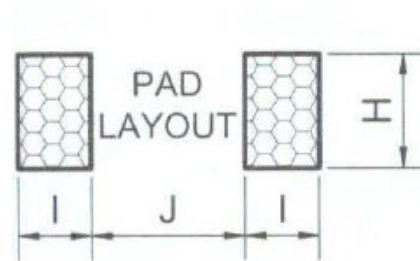
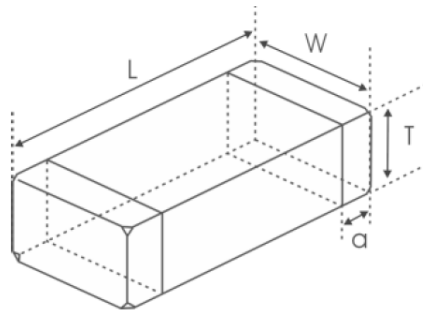

L	W	T	a	H	I	J
3.20±0.20	1.60±0.20	1.10±0.20	0.50±0.30	1.80 Ref.	1.05 Ref.	2.20 Ref.

Dimension: mm

Automotive Ferrite Chip Beads



AFBC-Q3211

Request Samples



Check Inventory



3.20 x 1.60 x 1.10 mm
RoHS/RoHS II Compliant
 MSL Level = 1

Materials

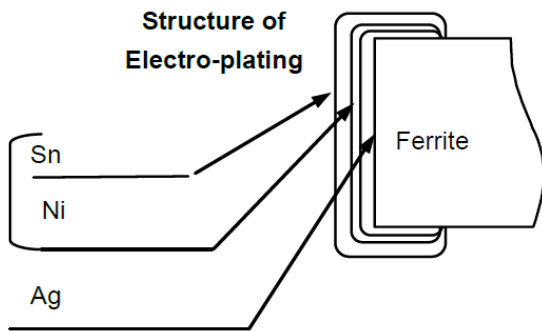

	Structure Description
1	Ferrite for Beads
2	Internal Terminal Electrode: Ag (100%)
3	Electro-plating: Ni (100%)
4	External Electro-plating: Sn (100%)

Reflow Profile

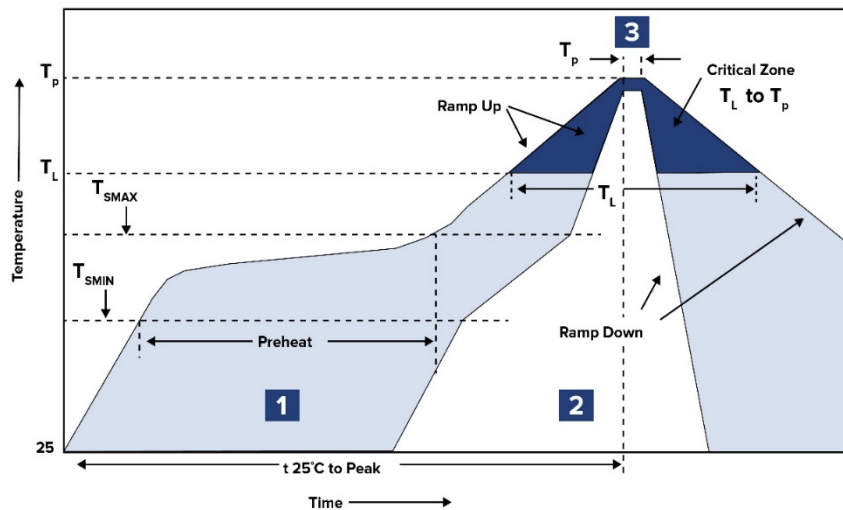

Zone	Description	Temperature	Times
1	Preheat	$T_{SMIN} \sim T_{SMAX}$ 150°C ~ 200°C	60 ~ 180 sec.
2	Reflow	T_L 245°C	20 ~ 40 sec.
3	Peak heat	T_P 260°C	10 sec. MAX

Automotive Ferrite Chip Beads

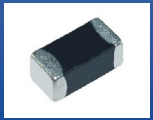

AFBC-Q3211

Request Samples



Check Inventory



3.20 x 1.60 x 1.10 mm
RoHS/RoHS II Compliant
MSL Level = 1

Packaging

T= Tape and reel (3,000 pcs/reel)

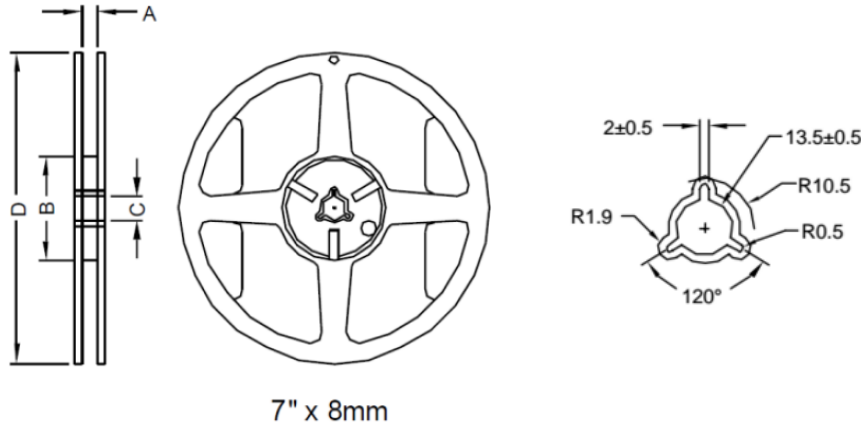

Type	A	B	C	D
7"x8mm	9.0 ± 0.5	60.0 ± 2.0	13.5 ± 0.5	178.0 ± 2.0

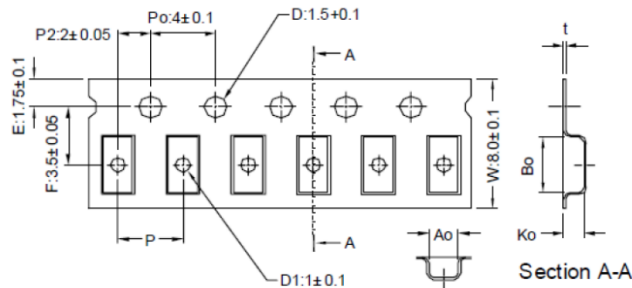

Series	Bo	Ao	Ko	P
AFBC-Q3211	3.35 ± 0.1	1.75 ± 0.1	1.25 ± 0.1	4.00 ± 0.10

Dimension: mm

ATTENTION: Abracon LLC's products are COTS – Commercial-Off-The-Shelf products; suitable for Commercial, Industrial and, where designated, Automotive Applications. Abracon's products are not specifically designed for Military, Aviation, Aerospace, Life-dependent Medical applications or any application requiring high reliability where component failure could result in loss of life and/or property. For applications requiring high reliability and/or presenting an extreme operating environment, written consent and authorization from Abracon LLC is required. Please contact Abracon LLC for more information.



5101 Hidden Creek Ln Spicewood TX 78669
 Phone: 512-371-6159 | Fax: 512-351-8858
 For terms and conditions of sales, please visit:
www.abracon.com

REVISION: IR 08-10-22

ABRACON IS
 ISO9001-2015
 CERTIFIED

X-ON Electronics

Largest Supplier of Electrical and Electronic Components

Click to view similar products for [Ferrite Beads](#) category:

Click to view products by [Abracon](#) manufacturer:

Other Similar products are found below :

[CZB1EGTTP700P](#) [CZB1JGTTD152P](#) [CZB2AFTTD800P](#) [CZB2AGTTD121P](#) [PE-0402FB121ST](#) [AB 3X2X3SM](#) [DER0705-2.2](#)
[NCB0603R301TR050F](#) [NCB0805A320TR050F](#) [NCB-H1206B680TR300F](#) [CZB1JGTTD221P](#) [CZB1JGTTD600P](#) [CZB2AGTTD301P](#)
[CZB2BFTTE301P](#) [CZB2BFTTE601P](#) [4221R-1](#) [EMI0805R-600](#) [SBY100505T-100Y-N](#) [NCB-GH0402D121TR060F](#) [NCB0402P301TR005F](#)
[NCB0603R152TR030F](#) [NCB0805A121TR050F](#) [NCB0805A301TR070F](#) [NCB3312K900TR500F](#) [NCB-H0805A221TR300F](#)
[NCB0402P221TR030F](#) [NCB0805A102TR040F](#) [NCB1806E151TR020F](#) [NCB-H0402P100TR200F](#) [NCB-H0603R121TR300F](#) [NCB-](#)
[H0805A220TR600F](#) [NCB-H0805A390TR400F](#) [NCB-H1206B601TR200F](#) [CZB1JGTTD202P](#) [CBH160808W221T](#) [WLBD1005HCU330TL](#)
[WLBD2012HCU121TH](#) [WLBD2012HCU221TH](#) [WQBD1608HCU121TH](#) [WLBD1608K2U252TB](#) [VLU0810-102KBC12](#)
[WLBD1608K2U800TP](#) [BMB2A0080AN4](#) [SZ1608F470TF](#) [FBSHC0805-331-302R](#) [HFJ100505T-601Y-N](#) [HFY100505T-221Y-N](#)
[PBY201209T-110Y-N](#) [SBY060303T-121Y-N](#) [SBY100505T-750Y-N](#)