

# 5G/4G/LTE Flexible Antenna



**AFC8513U4G**

Request Samples



Check Inventory



85 x 13.8 x 0.2 mm  
**RoHS/RoHS II Compliant**  
MSL Level = 1

## Features

- Wide Band
- Cellular 5G/4G/LTE/2G/3G/GSM
- Dual-band Wi-Fi 2.4/5GHz
- GNSS - GPS/GLONASS/BeiDou/QZSS/COMPASS
- Compact design
- Peak Gain of 5dBi
- Linear Polarization
- High Efficiency (>60% across all bands)
- Easy installation using adhesive tape
- Fully customizable cable and connector options for RF connection

## Applications

- IoT
- M2M
- Wearables
- Set Top Boxes
- Transportation
- Home Automation
- Smart Metering/City

## Product Image



# 5G/4G/LTE Flexible Antenna



**AFC8513U4G**

Request Samples



Check Inventory



85 x 13.8 x 0.2 mm  
**RoHS/RoHS II Compliant**  
 MSL Level = 1

## Part Number Builder

AFC8513U4G  -

Color	
Code	Description
S (Standard)	Black
A	White

Cable length in 'mm'	
Cable length supported : Ø1.13 mm (50 mm to 500 mm)	
Code	Description
0100 (Standard)	100 mm
Other Examples :	
0050	50 mm
0200	200 mm

Cable Type & Connector Type		
Code	Cable Type	Connector Type
S (Standard)	Ø1.13 mm	IPEX-1 (F)
A		IPEX-4 (F)
B		MMCX (F)
C		MMCX (M)
D		MCX (F)
E		MCX (M)
F		SMA (F)
G		SMA (M)
H		RP-SMA (F)
I		RP-SMA (M)
J		SMB (F)
K		SMB (M)
L		FAKRA-D (F)

### Example Configurations :

Part Number	Color	Cable length	Cable Type / Connector Type
AFC8513U4GS-0100S	Black	0100 mm	Ø1.13 mm with IPEX-1 (F) (Standard)
AFC8513U4GA-0050A	White	0050 mm	Ø1.13 mm with IPEX-4 (F)

### Note :

- For the standard part number (AFC8513U4GS-0100S), please refer to the packaging at the end of the document.
- For custom configurations (AFC8513U4G-), MOQs, pricing and packaging changes may be applicable.



5101 Hidden Creek Ln Spicewood TX 78669  
 Phone: 512-371-6159 | Fax: 512-351-8858  
 For terms and conditions of sales, please visit:  
[www.abracon.com](http://www.abracon.com)

REVISED: 04-06-20

ABRACON IS  
 ISO9001-2015  
 CERTIFIED

# 5G/4G/LTE Flexible Antenna



AFC8513U4G

Request Samples



Check Inventory



85 x 13.8 x 0.2 mm  
RoHS/RoHS II Compliant  
MSL Level = 1

## Electrical Specification

Parameter	Specification			Unit
	Min	Typ	Max	
Operating Frequency	698		4000	MHz
VSWR			3	
Peak gain		5		dBi
Impedance		50		$\Omega$
Polarization	Linear			
Input Power			5	W

## Mechanical Specification

Parameter	Specification
Antenna Dimensions	85 x 13.8 x 0.2 mm
Antenna Type	Flexible Printed Circuit
Mounting Type	Adhesive
RF Connector	I-PEX 1 (F)
RF Cable Type	$\varnothing$ 1.13 mm
Cable Length	100 mm

## Environmental Specification

Parameter	Specification
Operating Temperature	-40°C to +85°C
ROHS Complaint	Yes
PB Free	Yes
ESD Sensitive	No
MSL Level	1
Vibration	10 to 55Hz with 1.5mm amplitude 2hours

# 5G/4G/LTE Flexible Antenna



AFC8513U4G

Request Samples



Check Inventory



85 x 13.8 x 0.2 mm  
RoHS/RoHS II Compliant  
MSL Level = 1

## Product Dimension

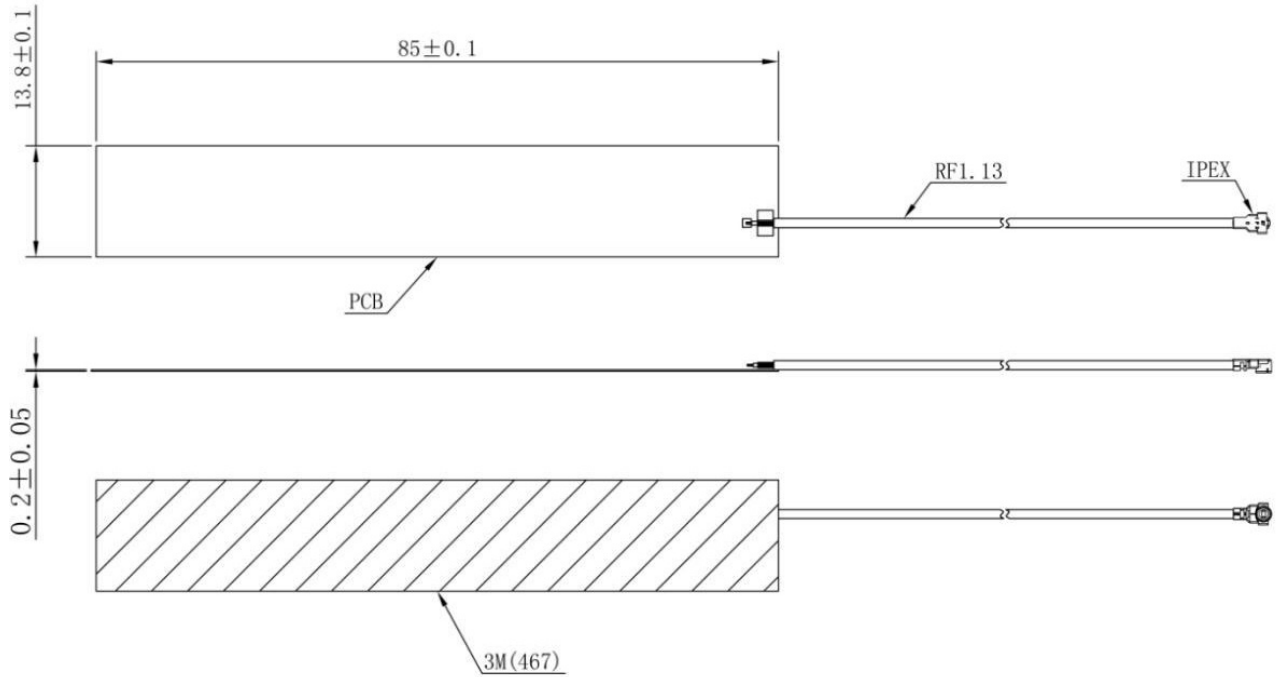

Unit : mm

# 5G/4G/LTE Flexible Antenna



**AFC8513U4G**

Request Samples



Check Inventory



85 x 13.8 x 0.2 mm  
RoHS/RoHS II Compliant  
MSL Level = 1

## Test Measurement - VSWR

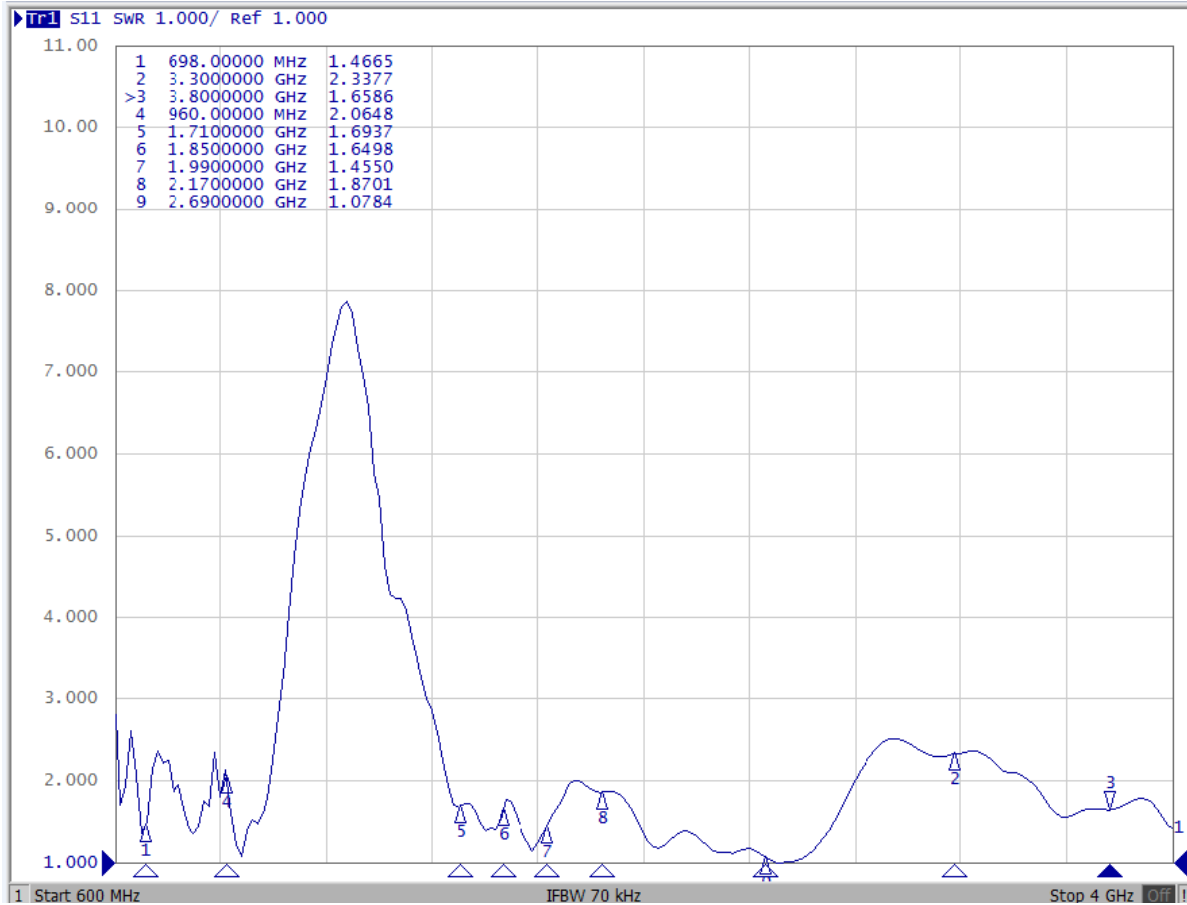

# 5G/4G/LTE Flexible Antenna



AFC8513U4G

Request Samples



Check Inventory



85 x 13.8 x 0.2 mm  
RoHS/RoHS II Compliant  
MSL Level = 1

## Radiation Characteristics

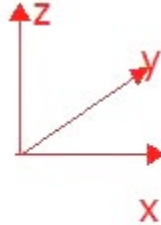

## 2D Pattern

XY - Plane

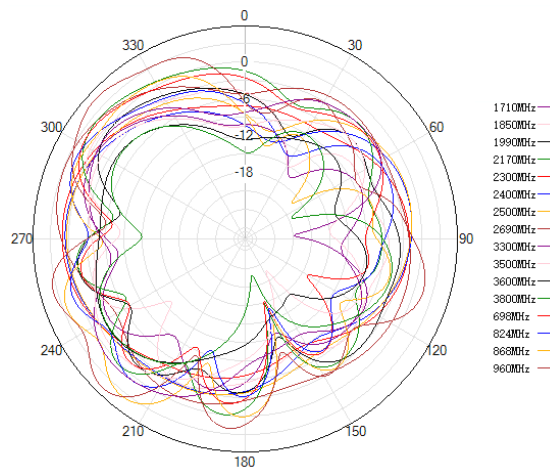

XZ - Plane

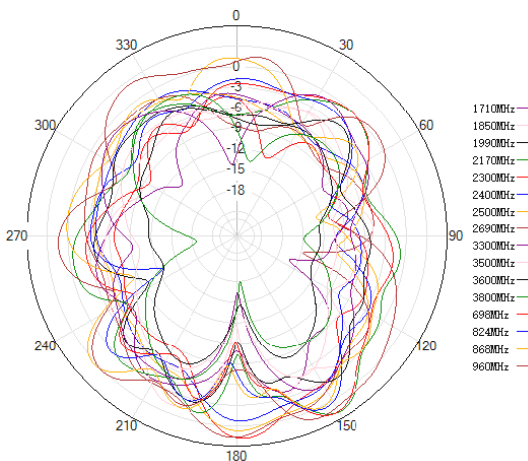

YZ - Plane

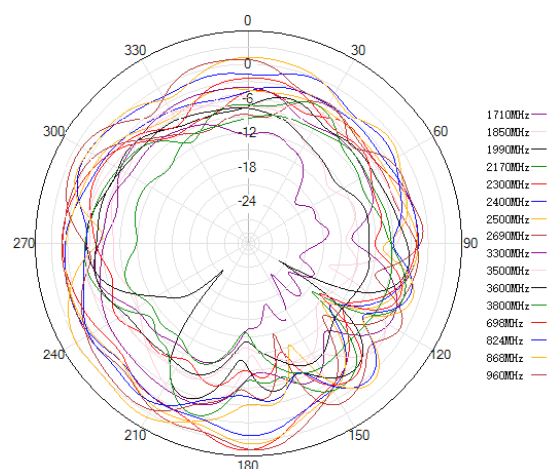

# 5G/4G/LTE Flexible Antenna



AFC8513U4G

Request Samples



Check Inventory



85 x 13.8 x 0.2 mm  
RoHS/RoHS II Compliant  
MSL Level = 1

## 3D Pattern

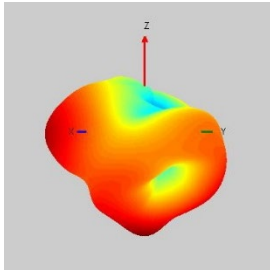

698 MHz

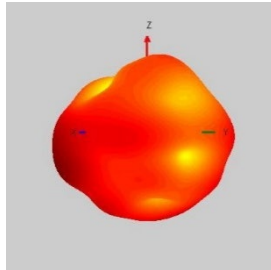

824 MHz

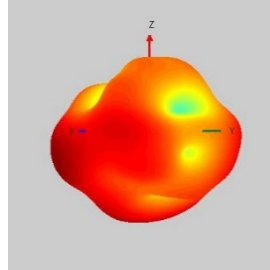

868 MHz

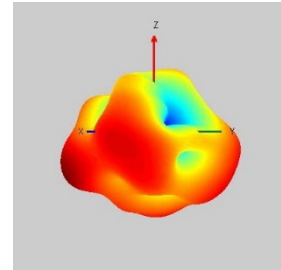

960 MHz

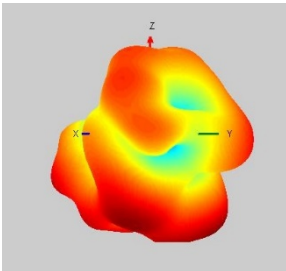

1710 MHz

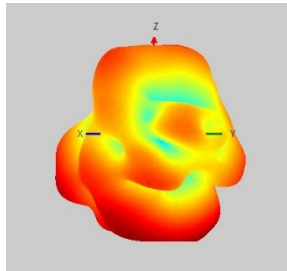

1850 MHz

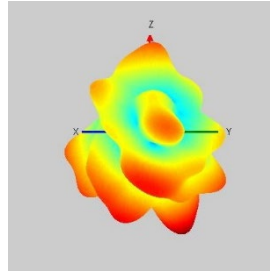

1990 MHz

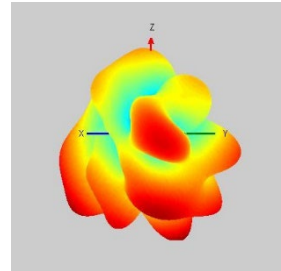

2170 MHz

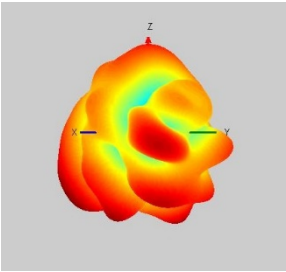

2300 MHz

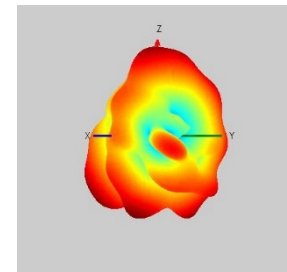

2400 MHz

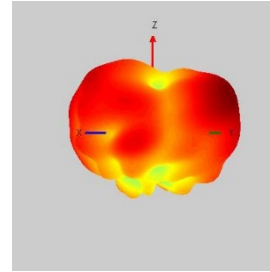

2500 MHz

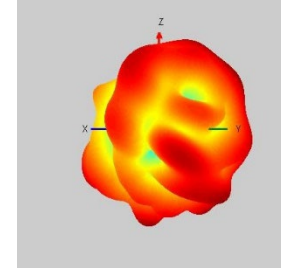

2690 MHz

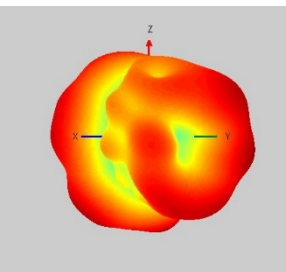

3300 MHz

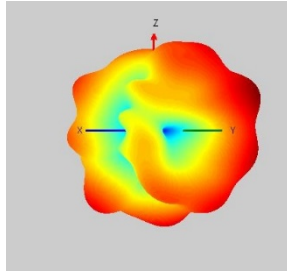

3500 MHz

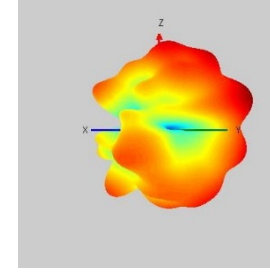

3600 MHz

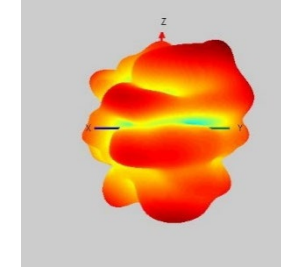

3800 MHz

# 5G/4G/LTE Flexible Antenna



AFC8513U4G

Request Samples



Check Inventory



85 x 13.8 x 0.2 mm  
RoHS/RoHS II Compliant  
MSL Level = 1

## Gain and Efficiency

Frequency (MHz)	Efficiency	Gain (dBi)
698	0.65	4.82
824	0.61	2.28
960	0.63	4.77
1710	0.67	5.1
1990	0.61	2.38
2170	0.62	2.47
2690	0.66	5.2
3300	0.63	2.8
3800	0.60	0.69

## Packaging Information

Number of Antenna/ Carton : 1000 pcs  
Dimension of the Carton : 370 x 360 x 170 mm  
Weight of the Carton : 4 kg

**ATTENTION:** Abracon LLC's products are COTS – Commercial-Off-The-Shelf products; suitable for Commercial, Industrial and, where designated, Automotive Applications. Abracon's products are not specifically designed for Military, Aviation, Aerospace, Life-dependent Medical applications or any application requiring high reliability where component failure could result in loss of life and/or property. For applications requiring high reliability and/or presenting an extreme operating environment, written consent and authorization from Abracon LLC is required. Please contact Abracon LLC for more information.



5101 Hidden Creek Ln Spicewood TX 78669  
Phone: 512-371-6159 | Fax: 512-351-8858  
For terms and conditions of sales, please visit:  
[www.abracon.com](http://www.abracon.com)

REVISED: 04-06-20

ABRACON IS  
ISO9001-2015  
CERTIFIED



## X-ON Electronics

Largest Supplier of Electrical and Electronic Components

*Click to view similar products for [Antennas](#) category:*

*Click to view products by [Abracon](#) manufacturer:*

Other Similar products are found below :

[GAN30084EU](#) [930-033-R](#) [GW17.07.0250E](#) [1513563-1](#) [EXE902SM](#) [APAMPG-117](#) [MAF94383](#) [W3908B0100](#) [W6102B0100](#) [YE572113-30RSMM](#) [108-00014-50](#) [66089-2406](#) [A09-F8NF-M](#) [A09-F5NF-M](#) [RGFRA1903041A1T](#) [W3593B0100](#) [W3921B0100](#) [SIMNA-868](#) [SIMNA-915](#) [SIMNA-433](#) [W1044](#) [W1049B090](#) [A75-001](#) [WTL2449CQ1-FRSMM](#) [CPL9C](#) [EXB148BN](#) [0600-00060](#) [TRA9020S3PBN-001](#) [GD5W-28P-NF](#) [MA9-7N](#) [GD53-25](#) [GD5W-21P-NF](#) [EXB144SM](#) [C37](#) [MAF94051](#) [GD35-17P-NF](#) [P1744](#) [MA9-5N](#) [EXD420PL](#) [B1322NR](#) [QWFTB120](#) [MAF94271](#) [MAF94300](#) [GPSMB301](#) [FG4403](#) [AO-AGSM-OM54](#) [5200232](#) [MIKROE-2349](#) [WCM.01.0111](#) [MIKROE-2393](#)