

# Surface Mount 2017.50MHz SAW Filter

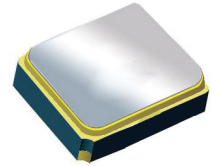

2.0 x 1.6 x 0.9 mm

**AFS20A15-2017.50-T3**

Moisture Sensitivity Level (MSL) – This product is Hermetically Sealed and not Moisture Sensitive - MSL = N/A: Not Applicable



**RoHS  
Compliant**

## FEATURES:

- 2.0 x 1.6 x 0.9 mm low profile SMT package
- Low Insertion loss
- Excellent selectivity with high out-of-band rejection

## APPLICATIONS:

- Wireless Communication
- Remote Control
- Cellular Phones

## ELECTRICAL SPECIFICATIONS:

### Maximum Ratings

Item	Value
Input Power Level	+10 dBm max.
DC Permissive Voltage	3.0V DC max.
Operating Temperature Range	-30°C to + 85°C
Storage Temperature Range	-40°C to + 95°C

Parameters	Minimum	Typical	Maximum	Units	Notes
Center Frequency ( $f_c$ )		2017.50		MHz	
Insertion Loss (IL)		1.25	2.20	dB	(2010 ~ 2025MHz)
Effective Bandwidth		15.00		MHz	
Amplitude Ripple		0.10	1.00	dB	(2010 ~ 2025MHz)
Worst-Case Input / Output Return Loss		16.54	10.16	dB	(2010 ~ 2025MHz)
Stop-band Attenuation (Referenced to 0.0 dB)	30	33		dB	(DC ~ 1020MHz)
	20	33			(1220 ~ 1570MHz)
	30	34			(1570 ~ 1590MHz)
	20	34			(1590 ~ 1820MHz)
	31	34			(1820 ~ 1850MHz)
	20	27			(1850 ~ 1950MHz)
	19	21			(2085 ~ 2400MHz)
	29	33			(2400 ~ 2430MHz)
	25	32			(2430 ~ 2790MHz)
	30	32			(2790 ~ 2820MHz)
	25	34			(2820 ~ 3000MHz)
	20	32			(3000 ~ 4010MHz)
	25	32			(4010 ~ 4060MHz)
10	22		(4060 ~ 6000MHz)		
Source Impedance ( $Z_s$ )		50		$\Omega$	See note # 1
Load Impedance ( $Z_L$ )		50		$\Omega$	See note # 1

**Note #1:** No matching network required for operation into 50 $\Omega$ 's

## TEST CIRCUIT:

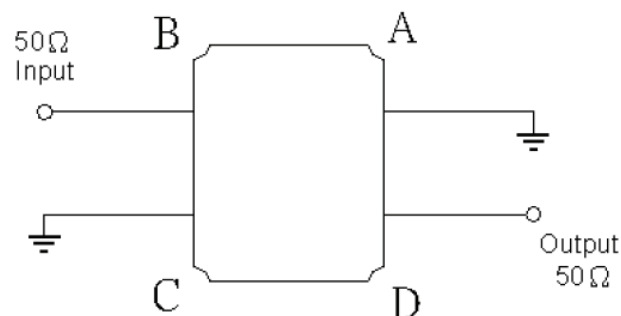

# Surface Mount 2017.50MHz SAW Filter

AFS20A15-2017.50-T3



RoHS  
Compliant

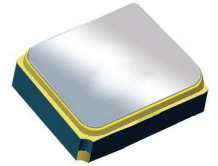

2.0 x 1.6 x 0.9 mm

## OUTLINE DIMENSIONS:

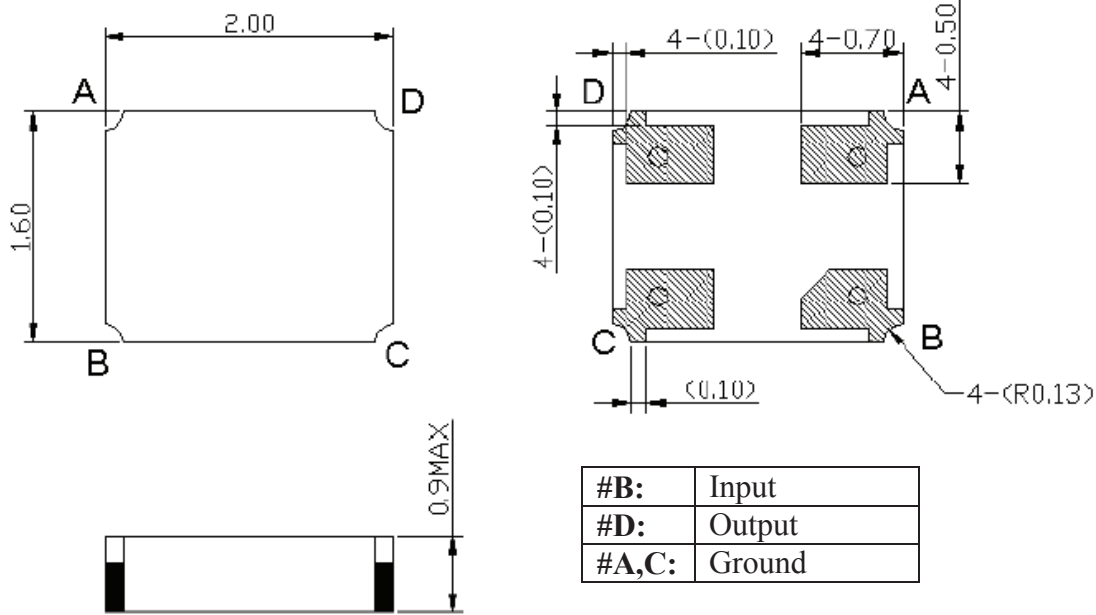

\*All Dimensions are in mm

## Recommended Land Pattern:

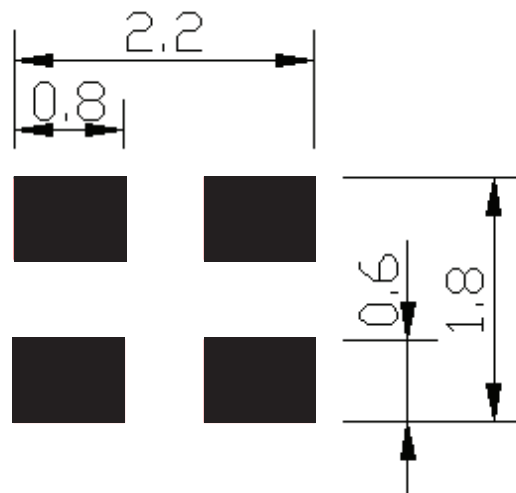

# Surface Mount 2017.50MHz SAW Filter

AFS20A15-2017.50-T3



RoHS  
Compliant

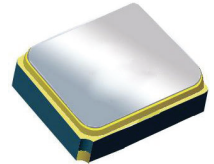

2.0 x 1.6 x 0.9 mm

## FREQUENCY CHARACTERISTICS:

### Filter Frequency Response (Narrowband)

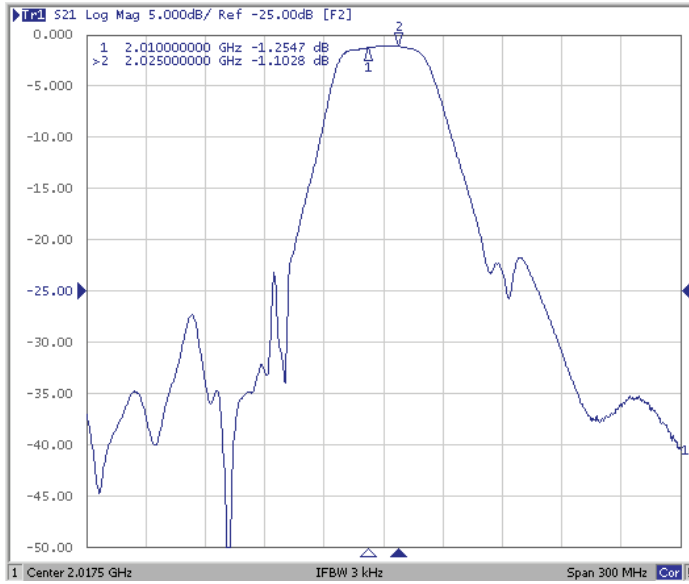

### Filter Frequency Response (Wideband)

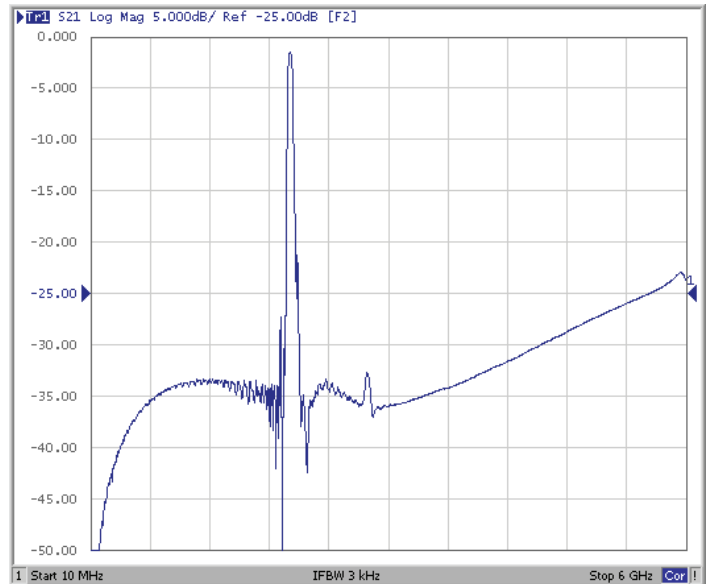

## REFLECTION FUNCTIONS:

### S11

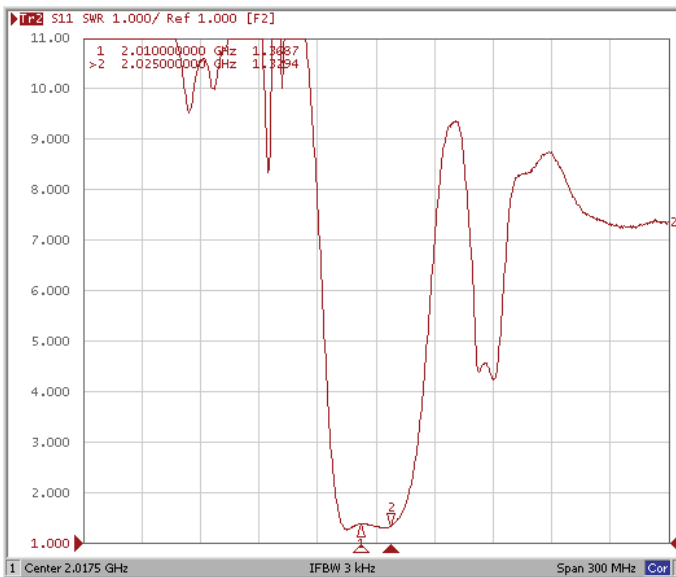

### S22

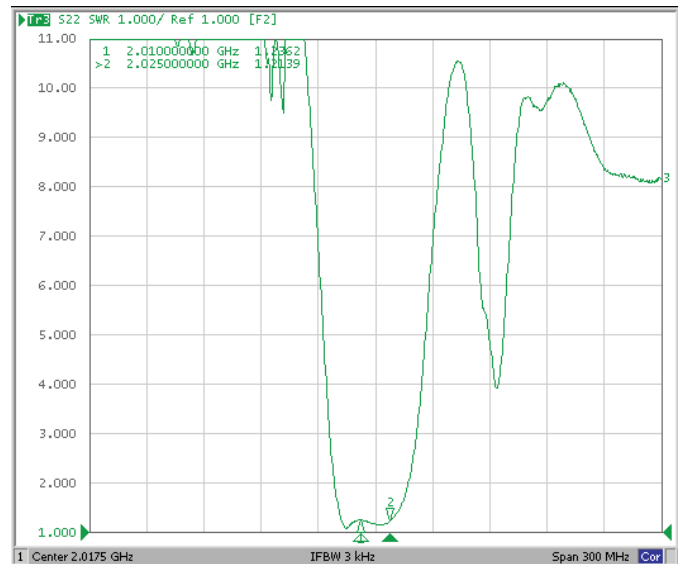

# Surface Mount 2017.50MHz SAW Filter

AFS20A15-2017.50-T3



RoHS  
Compliant

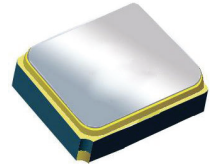

2.0 x 1.6 x 0.9 mm

## REFLOW PROFILE:

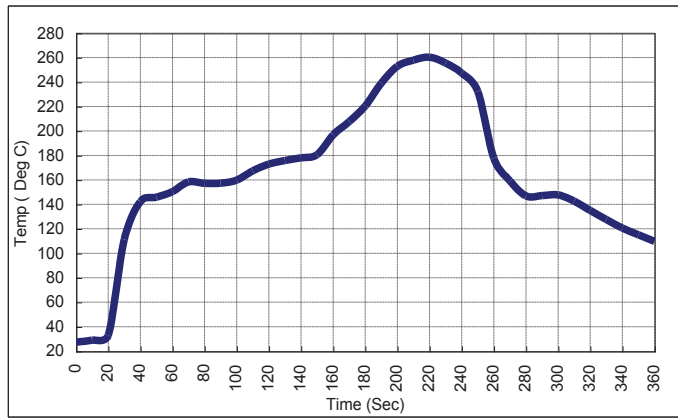

## PACKAGING: 3000 Units/Reel "T2" parts (2k/reel) are no longer available effective 01/01/2013

Reel Count : 7" = 3k units

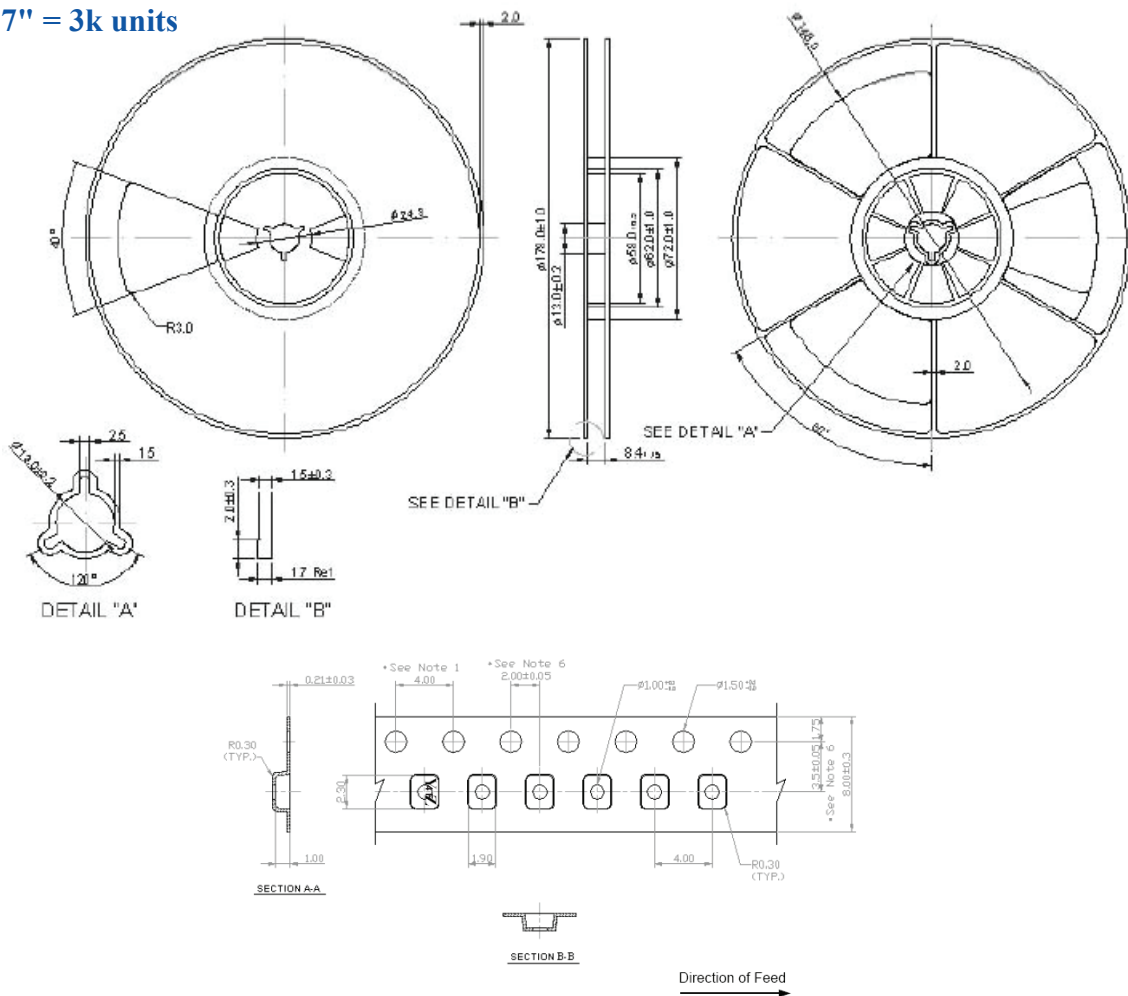

**ATTENTION:** Abracon Corporation's products are COTS – Commercial-Off-The-Shelf products; suitable for Commercial, Industrial and, where designated, Automotive Applications. Abracon's products are not specifically designed for Military, Aviation, Aerospace, Life-dependant Medical applications or any application requiring high reliability where component failure could result in loss of life and/or property. For applications requiring high reliability and/or presenting an extreme operating environment, written consent and authorization from Abracon Corporation is required. Please contact Abracon Corporation for more information.

ABRACON IS  
ISO 9001:2008  
CERTIFIED



Visit [www.abracon.com](http://www.abracon.com) for Terms & Conditions of Sale  
30332 Esperanza, Rancho Santa Margarita, California 92688  
tel 949-546-8000 | fax 949-546-8001 | [www.abracon.com](http://www.abracon.com)

Revised: 04.16.13

## X-ON Electronics

Largest Supplier of Electrical and Electronic Components

*Click to view similar products for [Signal Conditioning category](#):*

*Click to view products by [ABRACON manufacturer](#):*

Other Similar products are found below :

[MAPDCC0004](#) [PD0409J5050S2HF](#) [880157](#) [HHS-109-PIN](#) [DC1417J5005AHF](#) [DC4859J5005AHF](#) [AFS14A30-2185.00-T3](#) [AFS14A35-1591.50-T3](#) [DS-323-PIN](#) [DSS-313-PIN](#) [B39321R801H210](#) [B39321R821H210](#) [B39921B4317P810](#) [1A0220-3](#) [2089-6207-00](#) [JP510S](#) [LFB212G45SG8C341](#) [LFB322G45SN1A504](#) [LFL182G45TC3B746](#) [SF2159E](#) [30057](#) [1P510S](#) [CER0813B](#) [3A325](#) [40287](#) [41180](#) [ATB3225-75032NCT](#) [B69842N5807A150](#) [BD0810N50100AHF](#) [BD2326L50200AHF](#) [BD2425J50200AHF](#) [HMC189AMS8TR](#) [C5060J5003AHF](#) [JHS-114-PIN](#) [JP503AS](#) [DC0710J5005AHF](#) [DC2327J5005AHF](#) [DC3338J5005AHF](#) [43020](#) [LFB2H2G60BB1C106](#) [LFL15869MTC1B787](#) [X3C19F1-20S](#) [XC3500P-20S](#) [10013-20](#) [SF2081E](#) [SF2194E](#) [SF2238E](#) [CDBLB455KCAX39-B0](#) [RF1353C](#) [PD0922J5050D2HF](#)