

SMT Air Coil Inductor

AIAC-1512C

RoHS
Compliant

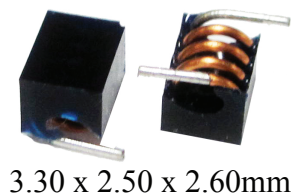

3.30 x 2.50 x 2.60mm

FEATURES:

- High current design
- Wide Range Frequency Response
- Excellent Q & SRF
- Standard flat cap top suitable for automatic placement.

APPLICATIONS:

- Widely used in Cordless Phones, High Frequency Communication Equipments, Intercom, CATV,RFID
- Suitable for metal sensors and proximity sensors
- Noise suppression for RF power supply/bias
- I/O filtering, frequency selection for audio devices such as Loudspeakers,Hifi
- Impedance Matching for transceivers
- Improves switch isolation for RF circuit

STANDARD SPECIFICATIONS:

PARAMETERS	
ABRACON P/N:	AIAC-1512C
Operating temperature:	-40 °C ~ +125 °C
Storage temperature:	-25°C to + 60°C

Part Number	Inductance	Tolerance	DCR (Max)	Q(Min)	SRF(Min)	Rated Current (Max)	Inductance Code
Units	nH	%	mΩ		GHz	A	
Symbol	L	J, K	DCR			IDC	
AIAC-1512C-2N5	2.50	K	0.8	145.0	3.0	4.8	2N5K
AIAC-1512C-5N0	5.00	K	1.5	140.0	3.0	4.6	5N0K
AIAC-1512C-8N0	8.00	K	2.3	140.0	3.0	4.5	8N0K
AIAC-1512C-12N5	12.50	J	3.0	137.0	3.0	4.3	12N5J
AIAC-1512C-18N5	18.50	J	3.9	132.0	2.5	4.0	18N5J

Test Conditions and equipments

Test frequency: 150MHz

Equipment: HP4191A

PART IDENTIFICATION:

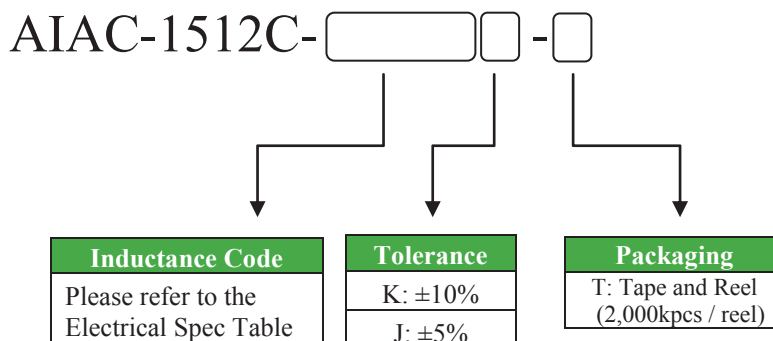

SMT Air Coil Inductor

AIAC-1512C

RoHS
Compliant

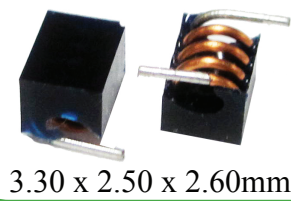

3.30 x 2.50 x 2.60mm

OUTLINE DRAWING:

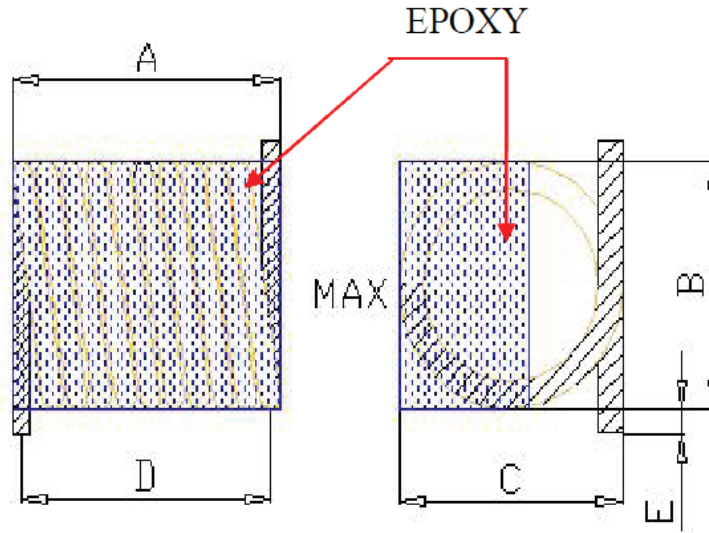

A	B	C	D	E
3.30±0.3	2.50±0.2	2.60±0.2	2.90±0.3	0.70±0.2

Schematic

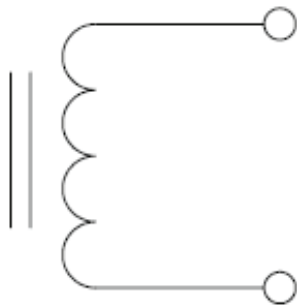

Recommended Land Pattern

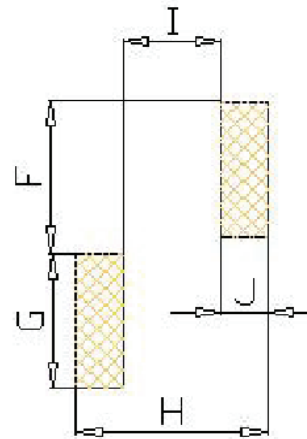

F	G	H	I	J
2.8	3.3	4.2	1.7	1.3

Dimension: mm

SMT Air Coil Inductor

AIAC-1512C

RoHS
Compliant

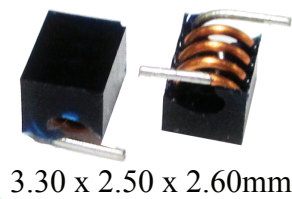

3.30 x 2.50 x 2.60mm

REFLOW PROFILE:

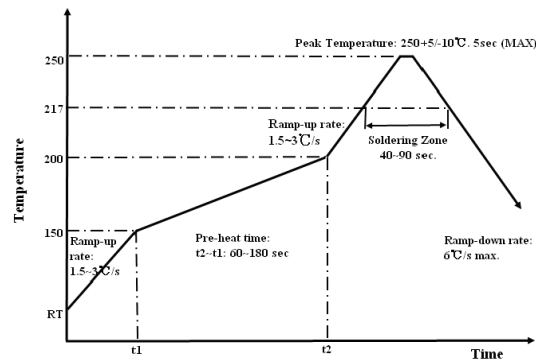

TAPE & REEL:

Packing
T: 2,000pcs / reel

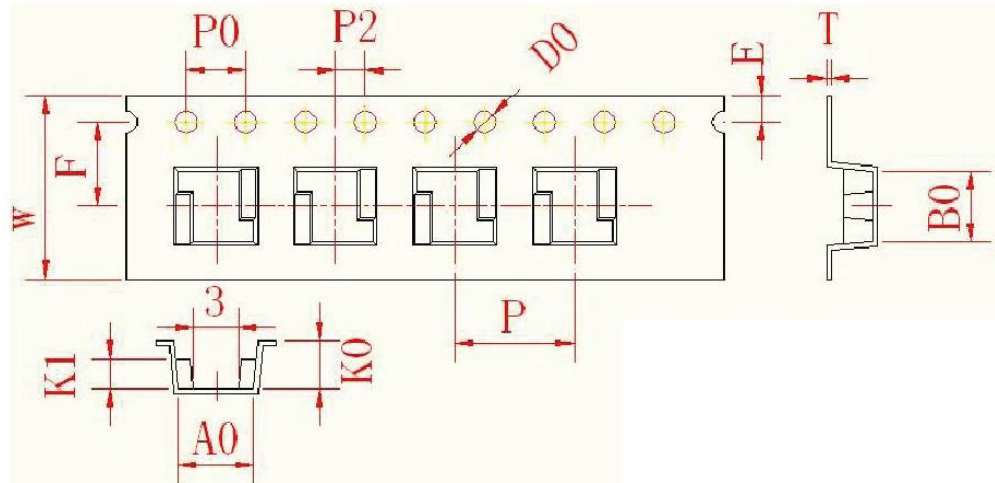

W	A0	B0	K0	K1	P	F	E	D0	P0	P2	T
12.0±0.3	5.1±0.1	4.6±0.1	3.1±0.1	1.9±0.1	8.0±0.1	5.5±0.1	1.75±0.1	1.5+0.1/-0	4.0±0.1	2.0±0.1	0.35±0.05

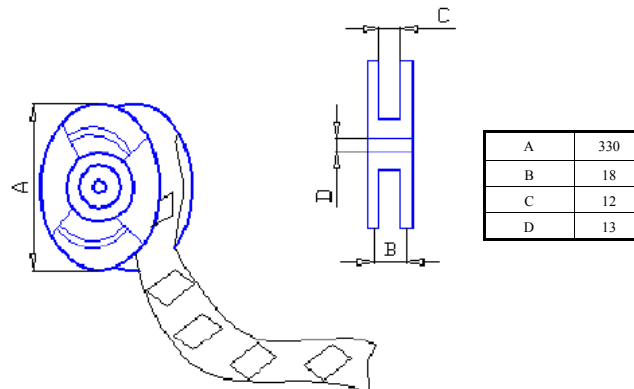

Dimension: mm

ATTENTION: Abracon Corporation's products are COTS – Commercial-Off-The-Shelf products; suitable for Commercial, Industrial and, where designated, Automotive Applications. Abracon's products are not specifically designed for Military, Aviation, Aerospace, Life-dependant Medical applications or any application requiring high reliability where component failure could result in loss of life and/or property. For applications requiring high reliability and/or presenting an extreme operating environment, written consent and authorization from Abracon Corporation is required. Please contact Abracon Corporation for more information.

ABRACON IS
ISO 9001:2008
CERTIFIED



Visit www.abracon.com for Terms & Conditions of Sale
30332 Esperanza, Rancho Santa Margarita, California 92688
tel 949-546-8000 | fax 949-546-8001 | www.abracon.com

Revised: 11.20.12

X-ON Electronics

Largest Supplier of Electrical and Electronic Components

Click to view similar products for [Fixed Inductors](#) category:

Click to view products by [ABRACON](#) manufacturer:

Other Similar products are found below :

[CR43NP-680KC](#) [CR54NP-820KC](#) [CR54NP-8R5MC](#) [CTX32CT-100](#) [70F224AI](#) [MGDQ4-00004-P](#) [MHL1ECTTP18NJ](#) [MHL1JCTTD12NJ](#)
[PE-51506NL](#) [PE-53601NL](#) [PE-53630NL](#) [PE-53824SNLT](#) [PE-62892NL](#) [PE-92100NL](#) [PG0434.801NLT](#) [PG0936.113NLT](#) [9310-16](#) [PM06-2N7](#) [PM06-39NJ](#) [A01TK](#) [1206CS-471XJ](#) [HC2-2R2TR](#) [HC2LP-R47-R](#) [HC3-2R2-R](#) [HCF1305-3R3-R](#) [1206CS-151XG](#) [RCH664NP-140L](#)
[RCH664NP-4R7M](#) [RCH8011NP-221L](#) [RCP1317NP-332L](#) [RCP1317NP-391L](#) [RCR1010NP-470M](#) [RCR110DNP-331L](#) [DH2280-4R7M](#)
[DS1608C-106](#) [ASPI-4020HI-R10M-T](#) [B10TJ](#) [B82477P4333M](#) [B82498B3101J000](#) [B82498B3680J000](#) [ELJ-RE27NJF2](#) [1812CS-153XJ](#)
[1812CS-183XJ](#) [1812CS-223XJ](#) [1812LS-104XJ](#) [1812LS-105XJ](#) [1812LS-124XJ](#) [1812LS-154XJ](#) [1812LS-223XJ](#) [1812LS-224XJ](#)