

SMT Air Coil Inductor

AIAC-1812

RoHS
Compliant

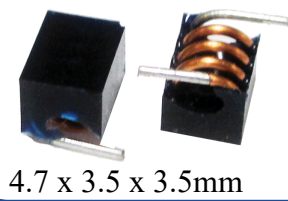

4.7 x 3.5 x 3.5mm

FEATURES:

- High current design
- Wide Range Frequency Response
- Excellent Q & SRF
- Standard flat cap top suitable for automatic placement.

APPLICATIONS:

- Widely used in Cordless Phones, High Frequency Communication Equipments, Intercom, CATV,RFID
- Suitable for metal sensors and proximity sensors
- Noise suppression for RF power supply/bias
- I/O filtering, frequency selection for audio devices such as Loudspeakers,Hifi
- Impedance Matching for transceivers
- Improves switch isolation for RF circuit

STANDARD SPECIFICATIONS:

PARAMETERS	
ABRACON P/N:	AIAC-1812
Operating temperature:	-40 °C ~ +125 °C
Storage temperature:	-25°C to + 60°C

Part Number	Inductance	Tolerance	DCR (Max)	Q(Min)	SRF(Min)	Rated Current (Max)	Inductance Code
Units	nH	%	mΩ		G Hz	A	
Symbol	L	J, K	DCR			IDC	
AIAC-1812-22N	22	K	4.8	100.0	3.20	3.2	22NK
AIAC-1812-27N	27	K	4.6	100.0	2.70	3.5	27NK
AIAC-1812-33N	33	K	5.9	100.0	2.50	3.0	33NK
AIAC-1812-39N	39	J	5.6	100.0	2.10	2.8	39NJ
AIAC-1812-47N	47	J	6.9	100.0	2.10	2.8	47NJ
AIAC-1812-56N	56	J	6.4	100.0	1.50	2.9	56NJ
AIAC-1812-68N	68	J	8.1	100.0	1.50	2.9	68NJ
AIAC-1812-82N	82	J	8.9	100.0	1.30	2.6	82NJ
AIAC-1812-R10	100	J	10.0	100.0	1.20	2.5	R10J
AIAC-1812-R12	120	J	11.1	100.0	1.10	2.2	R12J

Test Conditions and equipments

Test frequency: 150MHz

Equipment: HP4191A

PART IDENTIFICATION:

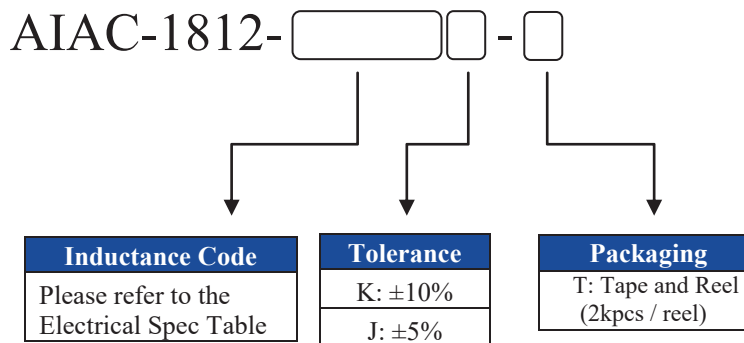

SMT Air Coil Inductor

AIAC-1812

RoHS
Compliant

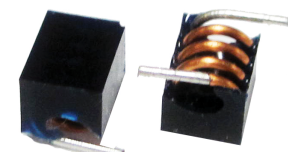

4.7 x 3.5 x 3.5mm

OUTLINE DRAWING:

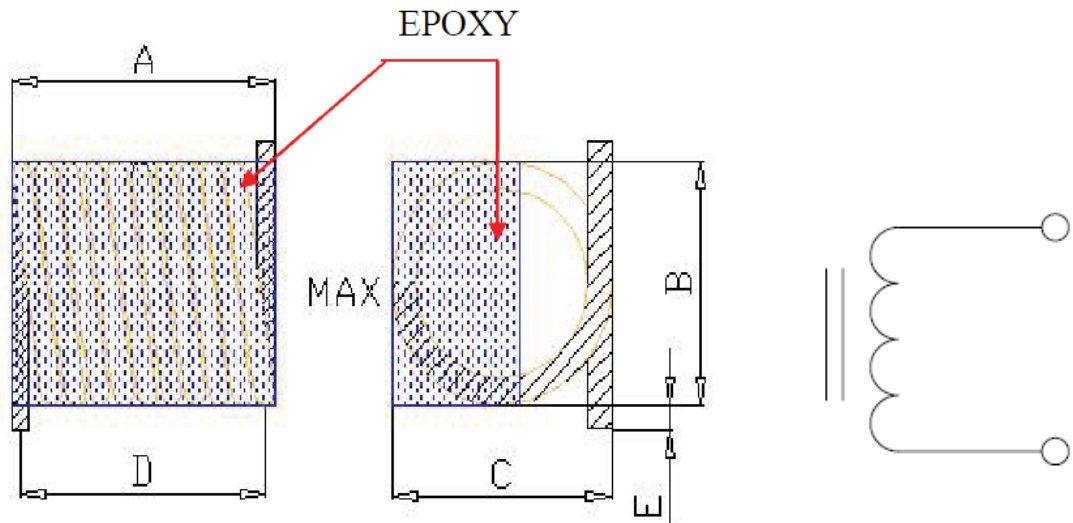

Inductance code	A	B	C	D	E
All others	4.7±0.3	3.5±0.2	3.5±0.2	4.3±0.4	1.0±0.3
R12J only	4.9±0.3	3.8±0.2	3.8±0.2		

Recommended Landing Pattern

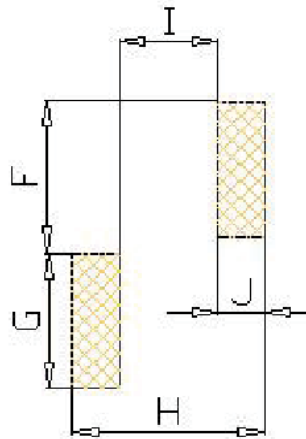

F	G	H	I	J
2.7	5.2	5.8	2.9	1.5

Dimension: inch (mm)

SMT Air Coil Inductor

AIAC-1812

RoHS
Compliant

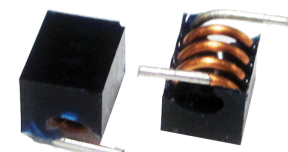

4.7 x 3.5 x 3.5mm

REFLOW PROFILE:

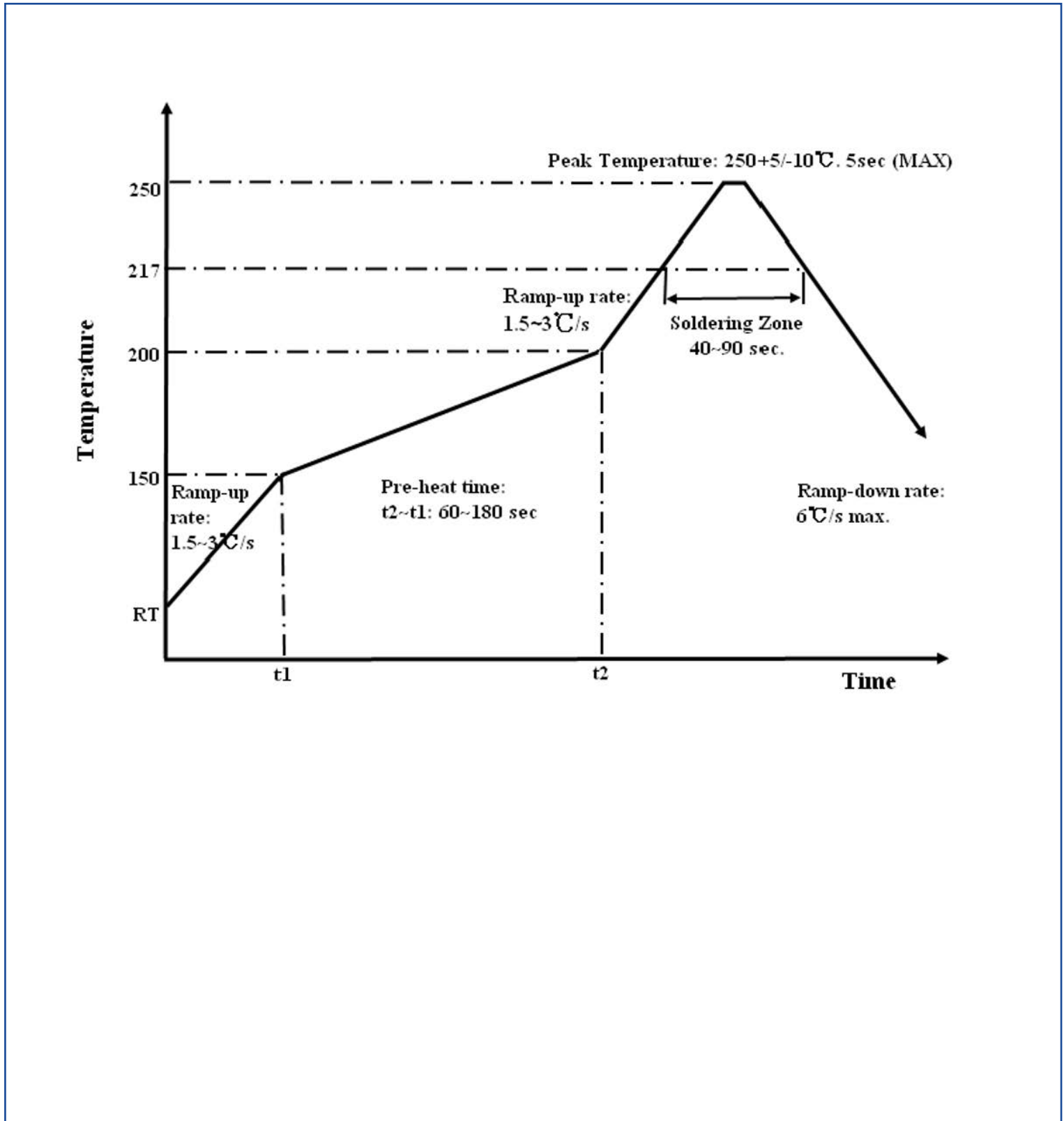

SMT Air Coil Inductor

AIAC-1812

RoHS
Compliant

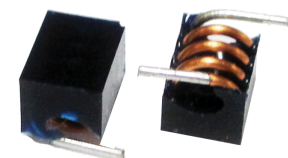

4.7 x 3.5 x 3.5mm

TAPE & REEL:

Packing
T: 2Kpcs / reel

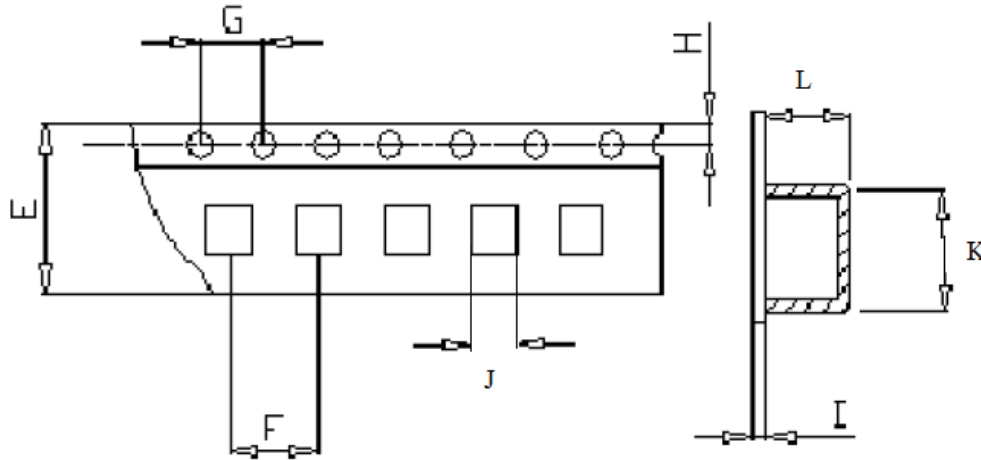

E	F	G	H	I	J max	K max	L max
16	8	4	1.75	0.4	5.70±0.1	7.10±0.1	4.20±0.1

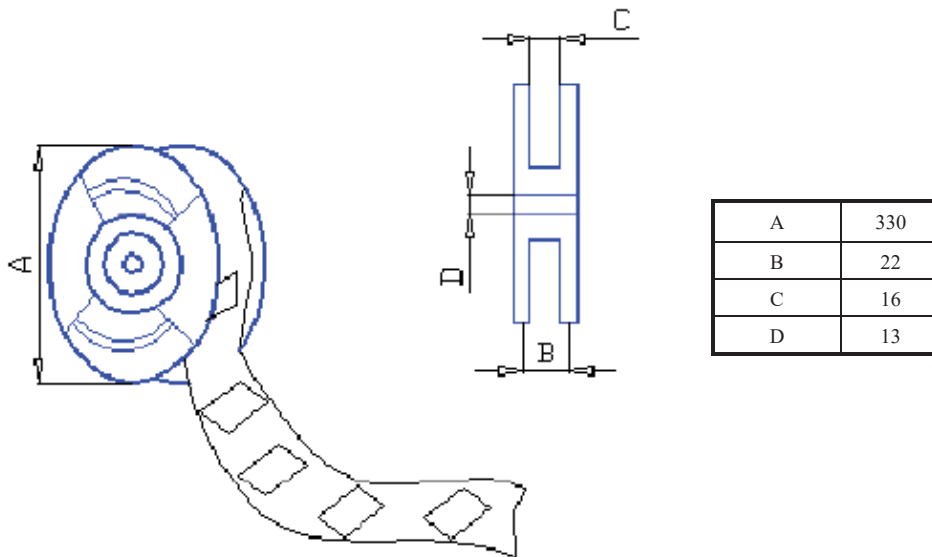

A	330
B	22
C	16
D	13

Dimension: mm

ATTENTION: Abracon Corporation's products are COTS – Commercial-Off-The-Shelf products; suitable for Commercial, Industrial and, where designated, Automotive Applications. Abracon's products are not specifically designed for Military, Aviation, Aerospace, Life-dependant Medical applications or any application requiring high reliability where component failure could result in loss of life and/or property. For applications requiring high reliability and/or presenting an extreme operating environment, written consent and authorization from Abracon Corporation is required. Please contact Abracon Corporation for more information.

X-ON Electronics

Largest Supplier of Electrical and Electronic Components

Click to view similar products for [Fixed Inductors](#) category:

Click to view products by [ABRACON](#) manufacturer:

Other Similar products are found below :

[CR43NP-680KC](#) [CR54NP-820KC](#) [CR54NP-8R5MC](#) [CTX32CT-100](#) [70F224AI](#) [MGDQ4-00004-P](#) [MHL1ECTTP18NJ](#) [MHL1JCTTD12NJ](#)
[PE-51506NL](#) [PE-53601NL](#) [PE-53602NL](#) [PE-53630NL](#) [PE-53824SNLT](#) [PE-62892NL](#) [PE-92100NL](#) [PG0434.801NLT](#) [PG0936.113NLT](#)
[9310-16](#) [PM06-2N7](#) [PM06-39NJ](#) [A01TK](#) [1206CS-471XJ](#) [HC2-2R2TR](#) [HC2LP-R47-R](#) [HC3-2R2-R](#) [HCF1305-3R3-R](#) [1206CS-151XG](#)
[RCH664NP-140L](#) [RCH664NP-4R7M](#) [RCH8011NP-221L](#) [RCP1317NP-332L](#) [RCP1317NP-391L](#) [RCR1010NP-470M](#) [RCR110DNP-331L](#)
[DH2280-4R7M](#) [DS1608C-106](#) [ASPI-4020HI-R10M-T](#) [B10TJ](#) [B82477P4333M](#) [B82498B3101J000](#) [B82498B3680J000](#) [ELJ-RE27NJF2](#)
[1812CS-153XJ](#) [1812CS-183XJ](#) [1812CS-223XJ](#) [1812LS-104XJ](#) [1812LS-105XJ](#) [1812LS-124XJ](#) [1812LS-154XJ](#) [1812LS-223XJ](#)