

# SMT Air Coil Inductor

AIAC-2712C

**RoHS**  
Compliant

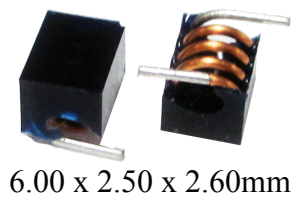

6.00 x 2.50 x 2.60mm

## FEATURES:

- High current design
- Wide Range Frequency Response
- Excellent Q & SRF
- Standard flat cap top suitable for automatic placement.

## APPLICATIONS:

- Widely used in Cordless Phones, High Frequency Communication Equipments, Intercom, CATV,RFID
- Suitable for metal sensors and proximity sensors
- Noise suppression for RF power supply/bias
- I/O filtering, frequency selection for audio devices such as Loudspeakers,Hifi
- Impedance Matching for transceivers
- Improves switch isolation for RF circuit

## STANDARD SPECIFICATIONS:

PARAMETERS	
ABRACON P/N:	AIAC-2712C
Operating temperature:	-40 °C ~ +125 °C
Storage temperature:	-25°C to + 60°C

Part Number	Inductance	Tolerance	DCR (Max)	Q(Min)	SRF(Min)	Rated Current (Max)	Inductance Code
Units	nH	%	mΩ		GHz	A	
Symbol	L	J	DCR			IDC	
AIAC-2712C-17N5	17.50	J	4.5	100.0	2.2	3.5	17N5J
AIAC-2712C-22N0	22.00	J	5.0	100.0	2.0	3.0	22N0J
AIAC-2712C-28N0	28.00	J	5.6	100.0	1.8	2.8	28N0J
AIAC-2712C-35N5	35.50	J	6.2	100.0	1.2	2.7	35N5J
AIAC-2712C-43N5	43.50	J	6.7	100.0	1.0	2.5	43N5J

## Test Conditions and equipments

Test frequency: 150MHz

Equipment: HP4191A

## PART IDENTIFICATION:

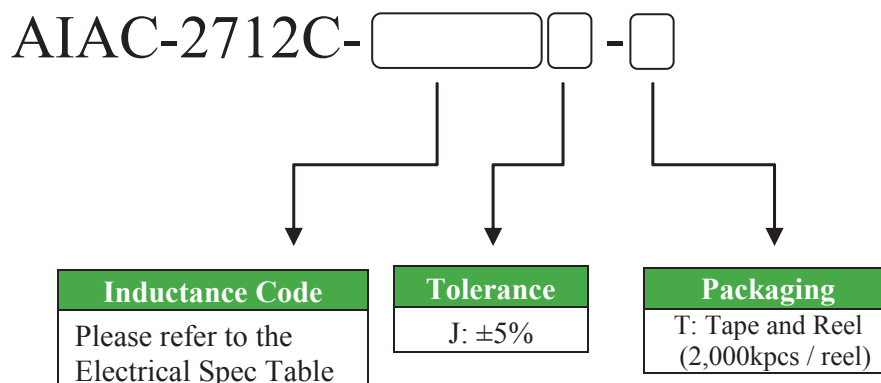

# SMT Air Coil Inductor

AIAC-2712C

**RoHS**  
Compliant

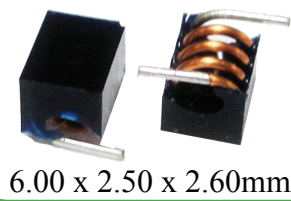

6.00 x 2.50 x 2.60mm

## OUTLINE DRAWING:

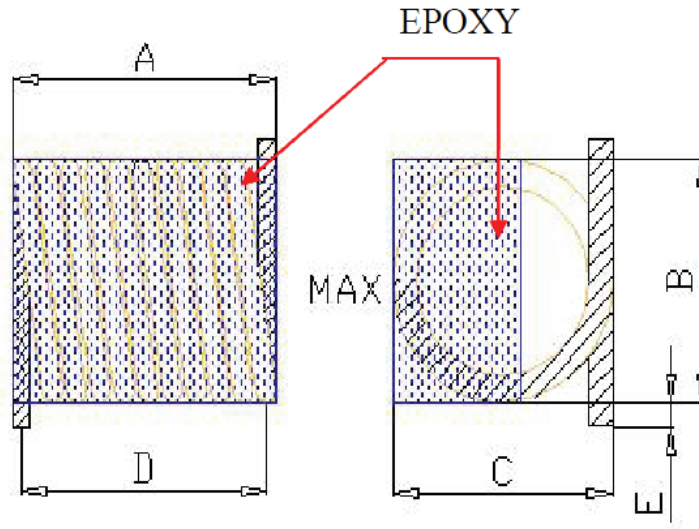

A	B	C	D	E
6.00±0.3	2.50±0.2	2.60±0.2	5.80±0.3	0.70±0.2

Schematic

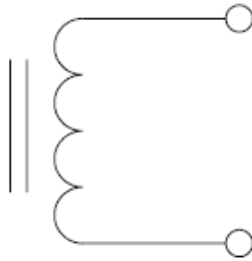

Recommended Land Pattern

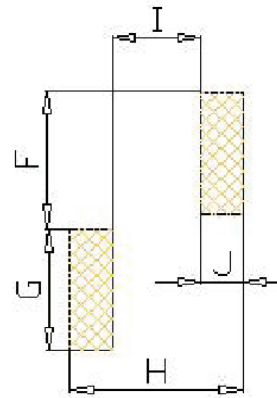

F	G	H	I	J
2.8	3.3	7.4	4.9	1.3

Dimension: mm

# SMT Air Coil Inductor

AIAC-2712C

RoHS  
Compliant

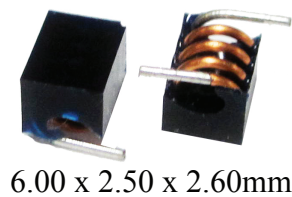

6.00 x 2.50 x 2.60mm

## REFLOW PROFILE:

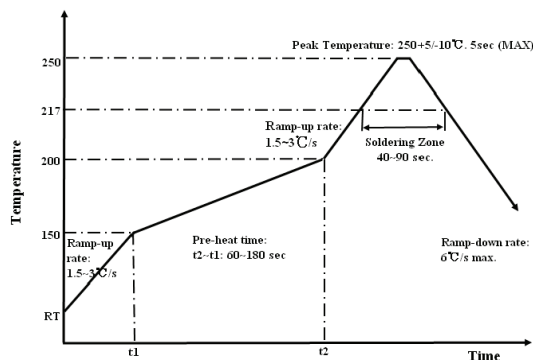

## TAPE & REEL:

Packing  
T: 2,000pcs / reel

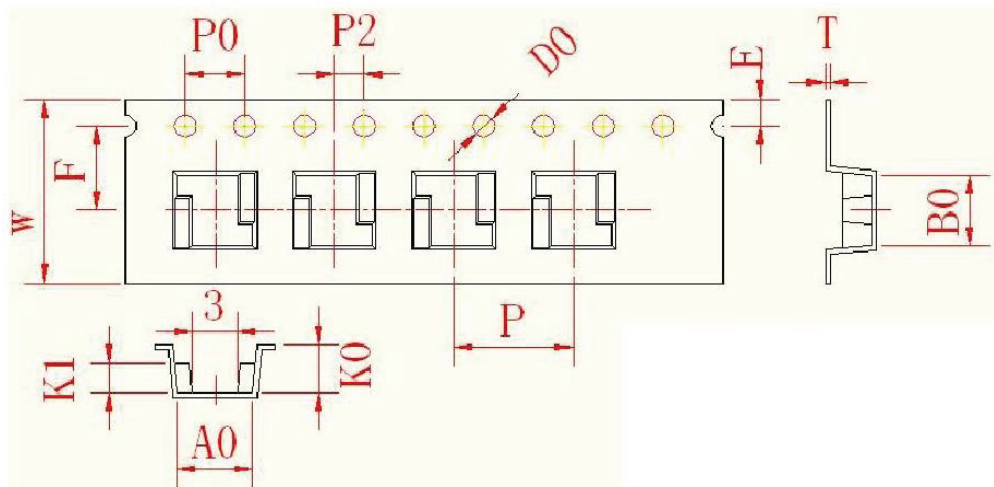

W	A0	B0	K0	K1	P	F	E	D0	P0	P2	T
16.0±0.3	4.7±0.1	6.8±0.1	3.2±0.1	2.0±0.1	8.0±0.1	7.5±0.1	1.75±0.1	1.5+0.1/-0	4.0±0.1	2.0±0.1	0.35±0.05

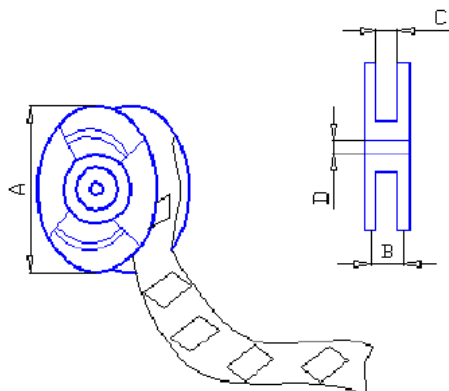

A	330
B	22
C	16
D	13

Dimension: mm

**ATTENTION:** Abracon Corporation's products are COTS – Commercial-Off-The-Shelf products; suitable for Commercial, Industrial and, where designated, Automotive Applications. Abracon's products are not specifically designed for Military, Aviation, Aerospace, Life-dependant Medical applications or any application requiring high reliability where component failure could result in loss of life and/or property. For applications requiring high reliability and/or presenting an extreme operating environment, written consent and authorization from Abracon Corporation is required. Please contact Abracon Corporation for more information.

ABRACON IS  
ISO 9001:2008  
CERTIFIED



Visit [www.abracon.com](http://www.abracon.com) for Terms & Conditions of Sale  
30332 Esperanza, Rancho Santa Margarita, California 92688  
tel 949-546-8000 | fax 949-546-8001 | [www.abracon.com](http://www.abracon.com)

Revised: 11.20.12

## X-ON Electronics

Largest Supplier of Electrical and Electronic Components

*Click to view similar products for [Fixed Inductors](#) category:*

*Click to view products by [ABRACON](#) manufacturer:*

Other Similar products are found below :

[CR43NP-680KC](#) [CR54NP-820KC](#) [CR54NP-8R5MC](#) [CTX32CT-100](#) [70F224AI](#) [MGDQ4-00004-P](#) [MHL1ECTTP18NJ](#) [MHL1JCTTD12NJ](#)  
[PE-51506NL](#) [PE-53601NL](#) [PE-53602NL](#) [PE-53630NL](#) [PE-53824SNLT](#) [PE-62892NL](#) [PE-92100NL](#) [PG0434.801NLT](#) [PG0936.113NLT](#)  
[9310-16](#) [PM06-2N7](#) [PM06-39NJ](#) [A01TK](#) [1206CS-471XJ](#) [HC2-2R2TR](#) [HC2LP-R47-R](#) [HC3-2R2-R](#) [HCF1305-3R3-R](#) [1206CS-151XG](#)  
[RCH664NP-140L](#) [RCH664NP-4R7M](#) [RCH8011NP-221L](#) [RCP1317NP-332L](#) [RCP1317NP-391L](#) [RCR1010NP-470M](#) [RCR110DNP-331L](#)  
[DH2280-4R7M](#) [DS1608C-106](#) [ASPI-4020HI-R10M-T](#) [B10TJ](#) [B82477P4333M](#) [B82498B3101J000](#) [B82498B3680J000](#) [ELJ-RE27NJF2](#)  
[1812CS-153XJ](#) [1812CS-183XJ](#) [1812CS-223XJ](#) [1812LS-104XJ](#) [1812LS-105XJ](#) [1812LS-124XJ](#) [1812LS-154XJ](#) [1812LS-223XJ](#)