

MULTILAYER CHIP CERAMIC INDUCTORS

AIMC-0201

RoHS
Compliant



0.6 x 0.3 x 0.3mm

FEATURES:

- High self-resonant frequency
- Multilayer monolithic construction yields high reliability
- Excellent solderability & heat resistance for reflow soldering

APPLICATIONS:

- Bluetooth
- Mobile phones such as GSM, CDMA, PDC
- High frequency telecommunication circuits
- Other high frequency circuit general use

STANDARD SPECIFICATIONS:

PARAMETERS

ABRACON P/N:	AIMC-0201-xxx Series
Operating temperature:	-55°C to + 125°C
Storage temperature:	-55°C to + 125°C

Part No.	L(nH)	Tolerance	Q	Q	Q	L,Q Test Freq. (MHz)	SRF(MHz)	DCR(Ω)	Ir(mA)
			(MIN @ 100MHz)	(MIN @ 800MHz)	(MIN @ 1800MHz)				
AIMC-0201-1N0	1.0	S	4	12	19	100	12000	0.20	300
AIMC-0201-1N2	1.2	S	4	12	18	100	11000	0.22	300
AIMC-0201-1N5	1.5	S	4	12	18	100	11000	0.24	300
AIMC-0201-1N8	1.8	S	4	11	17	100	10000	0.27	300
AIMC-0201-2N2	2.2	S	4	12	19	100	10000	0.30	300
AIMC-0201-2N7	2.7	S	4	13	19	100	10000	0.35	300
AIMC-0201-3N3	3.3	S	4	13	19	100	10000	0.40	200
AIMC-0201-3N9	3.9	S	4	13	19	100	9000	0.45	200
AIMC-0201-4N7	4.7	S	5	13	19	100	8500	0.50	200
AIMC-0201-5N6	5.6	S	5	12	18	100	8500	0.60	200
AIMC-0201-6N8	6.8	J	5	13	19	100	6000	0.65	200
AIMC-0201-8N2	8.2	J	5	13	19	100	6000	0.70	200
AIMC-0201-10N	10	J	5	13	18	100	5500	0.80	200
AIMC-0201-12N	12	J	5	12	18	100	5000	1.00	150
AIMC-0201-15N	15	J	5	12	17	100	4500	1.10	150
AIMC-0201-18N	18	J	5	12	16	100	4000	1.30	100
AIMC-0201-22N	22	J	5	12	16	100	3500	1.60	100
AIMC-0201-27N	27	J	5	12	15	100	3000	1.70	100
AIMC-0201-33N	33	J	5	11	14	100	2800	1.80	100
AIMC-0201-39N	39	J	4	11	-	100	1800	3.35	60
AIMC-0201-47N	47	J	4	11	-	100	1600	3.60	50

Test Conditions

L, Q: HP4291 Impedance Analyzer, 100MHz, 50mV
DCR: HP4263A LCR meter
SRF: HP4291 Impedance analyzer, HP8753 Network analyzer
Ir: DC Power Supplier, Current Meter, Thermometer.
 $\Delta L/L$ (initial) $\geq -5\%$ or $\Delta T \leq 20^\circ C$

Unless otherwise specified

Temperature : Ordinary Temperature (5 to 35°C)
Humidity : Ordinary Humidity (25 to 85% RH)
Atmospheric Pressure : 86 to 106 kPa

ELECTRICAL CHARACTERISTICS:

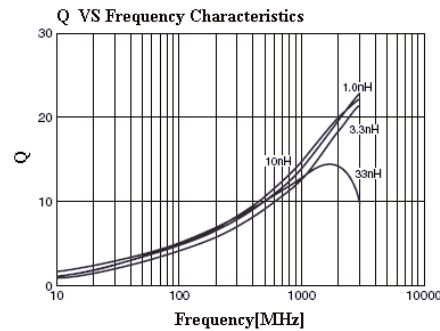
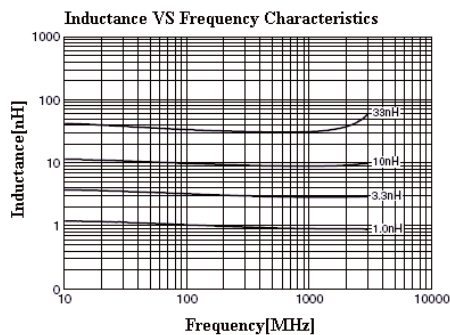

OPTIONS AND PART IDENTIFICATION: (Left blank if standard)

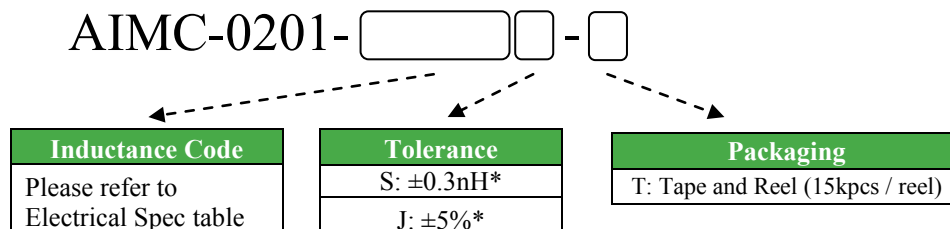

*S for L = 1.0~5.6nH only
 J for L = 6.8~47nH only

ABRACON IS
ISO 9001:2008
CERTIFIED



Visit www.abracon.com for Terms & Conditions of Sale
 30332 Esperanza, Rancho Santa Margarita, California 92688
 tel 949-546-8000 | fax 949-546-8001 | www.abracon.com

Revised: 06.02.11

MULTILAYER CHIP CERAMIC INDUCTORS



0.6 x 0.3 x 0.3mm

RoHS
Compliant

AIMC-0201

OUTLINE DRAWING:

Dimension: mm [inch]

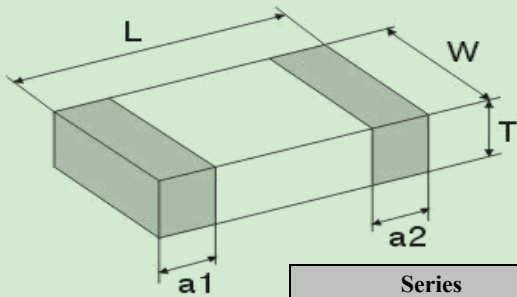

Series	L	W	T	a1,a2
AIMC-0201	0.60±0.05	0.30±0.05	0.30±0.05	0.10~0.20
	[0.024±0.002]	[0.012±0.002]	[0.012±0.002]	[0.004~0.008]

TAPE & REEL: T = Tape and reel 15,000pcs/reel

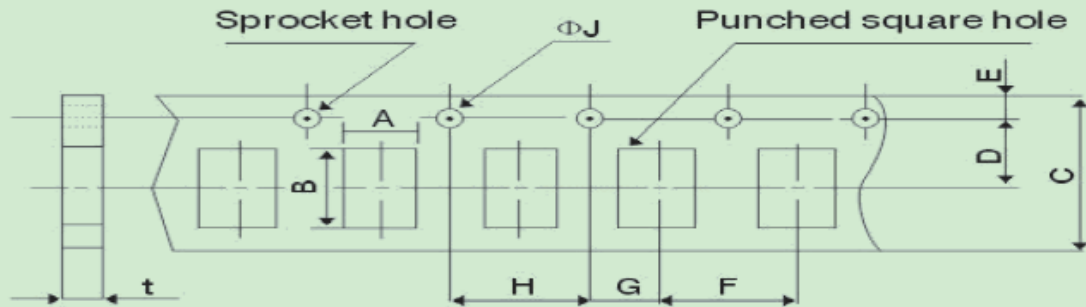

Codes	A	B	C	D	E	F	G	H	ΦJ	t(max)
AIMC-0201	0.4±0.05	0.7±0.05	8.0±0.3	3.5±0.05	1.75±0.1	2.0±0.05	2.0±0.05	4.0±0.1	1.5+0.1/-0	0.55±0.05

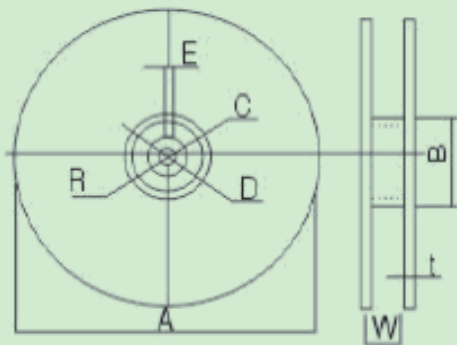

A	178±2
B	60±2
C	13.0±0.5
D	21.0±0.8
E	2.0±0.5
W	10.0±1.15
t	1.2±0.2
R	1.0±0.25

Peeling strength of cover tape

0.3~0.7N (30gf~70gf)

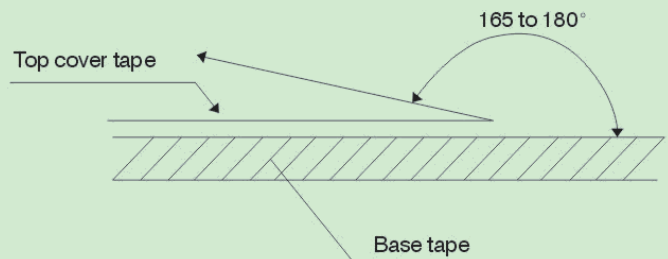

Test condition:

- 1) peel angle: 165°~180° vs. carrier tape.
- 2) peel speed: 300 mm/min±10%.

Dimension: mm

X-ON Electronics

Largest Supplier of Electrical and Electronic Components

Click to view similar products for [Fixed Inductors](#) category:

Click to view products by [ABRACON](#) manufacturer:

Other Similar products are found below :

[CR43NP-680KC](#) [CR54NP-820KC](#) [CR54NP-8R5MC](#) [CTX32CT-100](#) [70F224AI](#) [MGDQ4-00004-P](#) [MHL1ECTTP18NJ](#) [MHL1JCTTD12NJ](#)
[PE-51506NL](#) [PE-53601NL](#) [PE-53602NL](#) [PE-53630NL](#) [PE-53824SNLT](#) [PE-62892NL](#) [PE-92100NL](#) [PG0434.801NLT](#) [PG0936.113NLT](#)
[9310-16](#) [PM06-2N7](#) [PM06-39NJ](#) [A01TK](#) [1206CS-471XJ](#) [HC2-2R2TR](#) [HC2LP-R47-R](#) [HC3-2R2-R](#) [HCF1305-3R3-R](#) [1206CS-151XG](#)
[RCH664NP-140L](#) [RCH664NP-4R7M](#) [RCH8011NP-221L](#) [RCP1317NP-332L](#) [RCP1317NP-391L](#) [RCR1010NP-470M](#) [RCR110DNP-331L](#)
[DH2280-4R7M](#) [DS1608C-106](#) [ASPI-4020HI-R10M-T](#) [B10TJ](#) [B82477P4333M](#) [B82498B3101J000](#) [B82498B3680J000](#) [ELJ-RE27NJF2](#)
[1812CS-153XJ](#) [1812CS-183XJ](#) [1812CS-223XJ](#) [1812LS-104XJ](#) [1812LS-105XJ](#) [1812LS-124XJ](#) [1812LS-154XJ](#) [1812LS-223XJ](#)