

MULTILAYER FERRITE CHIP INDUCTOR

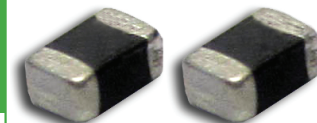

2.00 x 1.25 x 0.85 mm/
2.00 x 1.25 x 1.25 mm

AIML-0805

RoHS
Compliant

FEATURES:

- Monolithic structure for higher reliability, compact size, & lightweight
- Magnetically shielded design to eliminate cross coupling
- Excellent solderability and heat resistance for reflow soldering
- Perfect shape for PCB mounting with no polarity

APPLICATIONS:

- Resonance circuit, traps and filter circuits
- RF choke for cordless phones and radio equipment
- Communications, video and audio equipment, computer and remote Control.

STANDARD SPECIFICATIONS:

PARAMETERS

ABRACON P/N:	AIML-0805-xxx
Operating temperature:	-55°C to + 125°C
Storage temperature:	-55°C to + 125°C

Test Conditions and equipments

L, Q: HP4291 Impedance Analyzer

DCR: HP4263A LCR meter

SRF: HP4291 Impedance analyzer

Ir: HP4291 Impedance Analyzer, DC power HP6632 and Adapter HP16200. $\Delta L/L$ (initial) \geq -5%

Part No. AIML-0805- Inductance Code	L(μ H)	Tolerance	Q (min)	Test Freq.	SRF(MHz)	DCR(Ω)	Ir(mA)
		(%)		(MHz)	(min)	(max)	(max)
AIML-0805-R047	0.047	K	15	50	350	0.20	300
AIML-0805-R056	0.056	K	15	50	350	0.20	300
AIML-0805-R068	0.068	K	15	50	280	0.20	300
AIML-0805-R082	0.082	K	15	50	255	0.20	300
AIML-0805-R10	0.100	K	20	25	235	0.30	250
AIML-0805-R12	0.120	K	20	25	220	0.30	250
AIML-0805-R15	0.150	K	20	25	200	0.40	250
AIML-0805-R18	0.180	K	20	25	185	0.40	250
AIML-0805-R22	0.220	K	20	25	170	0.50	250
AIML-0805-R27	0.270	K	20	25	150	0.50	250
AIML-0805-R33	0.330	K	20	25	145	0.55	250
AIML-0805-R39	0.390	K	25	25	135	0.65	200
AIML-0805-R47	0.470	K	25	25	125	0.65	200
AIML-0805-R56	0.560	K	25	25	115	0.75	150
AIML-0805-R68	0.680	K	25	25	105	0.80	150
AIML-0805-R82	0.820	K	25	25	100	1.00	150
AIML-0805-1R0	1.000	K	45	10	75	0.40	50
AIML-0805-1R2	1.200	K	45	10	65	0.50	50
AIML-0805-1R5	1.500	K	45	10	60	0.50	50
AIML-0805-1R8	1.800	K	45	10	55	0.60	50
AIML-0805-2R2	2.200	K	45	10	50	0.65	30
AIML-0805-2R7	2.700	K	45	10	45	0.75	30
AIML-0805-3R3	3.300	K	45	10	41	0.80	30
AIML-0805-3R9	3.900	K	45	10	38	0.90	30
AIML-0805-4R7	4.700	K	45	10	35	1.00	30
AIML-0805-5R6	5.600	K	55	4	32	0.90	15
AIML-0805-6R8	6.800	K	55	4	29	1.00	15
AIML-0805-8R2	8.200	K	55	4	26	1.10	15
AIML-0805-100	10.000	K	55	2	24	1.15	15
AIML-0805-120	12.000	K	55	2	22	1.25	15
AIML-0805-150	15.000	K	40	1	19	0.80	5
AIML-0805-180	18.000	K	40	1	18	0.90	5
AIML-0805-220	22.000	K	40	1	16	1.10	5
AIML-0805-270	27.000	K	25	1	14	1.15	5
AIML-0805-330	33.000	K	25	1	13	1.25	5
AIML-0805-390	39.000	K	25	1	13	1.50	4

ABRACON IS
ISO 9001:2008
CERTIFIED



ABRACON
CORPORATION

Visit www.abracon.com for Terms & Conditions of Sale

30332 Esperanza, Rancho Santa Margarita, California 92688
tel 949-546-8000 | fax 949-546-8001 | www.abracon.com

Revised: 10.11.12

MULTILAYER FERRITE CHIP INDUCTOR

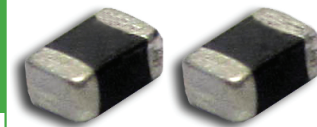

2.00 x 1.25 x 0.85 mm/
2.00 x 1.25 x 1.25 mm

AIML-0805

RoHS
Compliant

OPTIONS AND PART IDENTIFICATION:

AIML-0805---

Inductance Code

Please refer to the table above

Tolerance

K: $\pm 10\%$

Packaging

T: Tape and Reel
(4kpcs / reel for L less than 12 μ H;
3kpcs / reel for 12 μ H or above)

OUTLINE DRAWING:

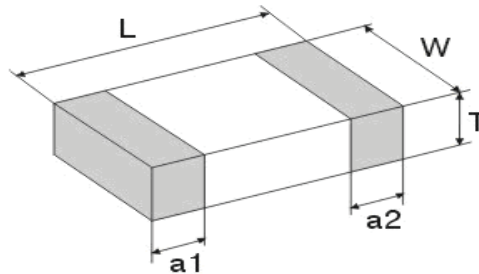

Dimension: mm [inch]

L	W	T	a1,a2
2.00 \pm 0.20 [0.079 \pm 0.008]	1.25 \pm 0.20 [0.049 \pm 0.008]	0.85 \pm 0.20 [0.033 \pm 0.008] for L less than 12 μ H; 1.25 \pm 0.20 [0.049 \pm 0.008] for 12 μ H or above	0.50 \pm 0.30 [0.02 \pm 0.012]

MATERIAL:

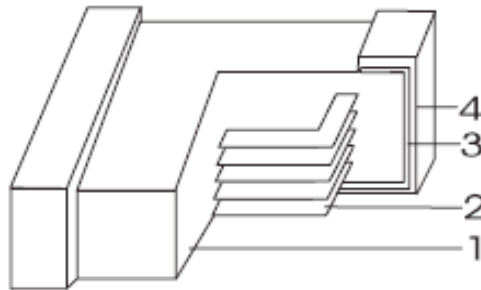

	Part Name	Material
1	Base Material	Ferrite (Ni-Cu-Zn series)
2	Internal Conductor	Ag
3	Terminal Electrode	Ag
4	Terminal Electrode	Ni-Sn

REFLOW PROFILE:

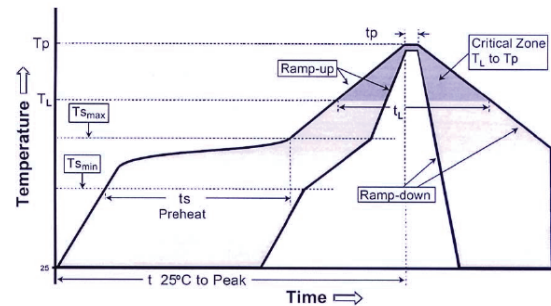

Profile Feature	Lead-Free Assembly
Average Ramp-Up Rate (T _{smax} to T _p)	3°C /second max.
Preheat - Temperature Min (T _{smin}) - Temperature Max (T _{smax}) - Time (t _{smin} to t _{smax}) min to t _{smax})	150 °C 200 °C 60-180 seconds
Time maintained above: - Temperature (T _L) - Time (t _L)	217 °C 60-150 seconds
Peak/Classification Temperature (T _p) Peak/Classification Time (T _p)	260 °C 3-4 seconds
Time within 5 °C of actual Peak Temperature (t _p)	20-40 seconds
Ramp-Down Rate	6°C/second max.
Time 25 °C to Peak Temperature	8 minutes max.

ABRACON IS
ISO 9001:2008
CERTIFIED



ABRACON
CORPORATION

Visit www.abracon.com for Terms & Conditions of Sale
30332 Esperanza, Rancho Santa Margarita, California 92688
tel 949-546-8000 | fax 949-546-8001 | www.abracon.com

Revised: 10.11.12

MULTILAYER FERRITE CHIP INDUCTOR

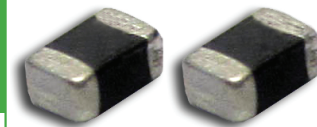

2.00 x 1.25 x 0.85 mm/
2.00 x 1.25 x 1.25 mm

AIML-0805

RoHS
Compliant

TAPE & REEL:

T: 4,000pcs / reel for L less than 12 μ H (paper tape); 3,000pcs / reel for 12 μ H or above (embossed tape)

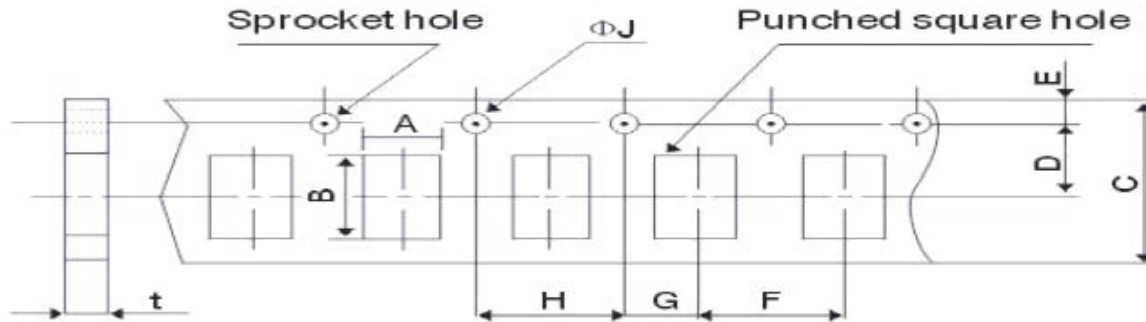

A	B	C	D	E	F	G	H	ΦJ	t(max)
1.5±0.15	2.5±0.2	8.0±0.3	3.5±0.05	1.75±0.1	4.0±0.1	2.0±0.05	4.0±0.1	1.5+0.1/-0	1.1±0.05 for L less than 12 μ H; 1.0±0.05 for 12 μ H or above

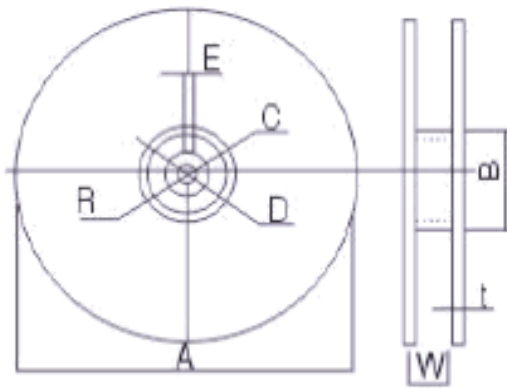

A	178±2
B	60±2
C	13.0±0.5
D	21.0±0.8
E	2.0±0.5
W	10.0±1.15
t	1.2±0.2
R	1.0±0.25

Peeling strength of cover tape

0.3~0.7N (30gf~70gf)

Test condition:

- 1) peel angle: 165°~180° vs. carrier tape.
- 2) peel speed: 300 mm/min±10%.

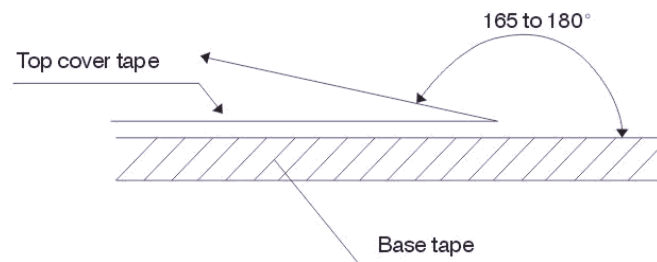

Dimension: mm

ATTENTION: Abracon Corporation's products are COTS – Commercial-Off-The-Shelf products; suitable for Commercial, Industrial and, where designated, Automotive Applications. Abracon's products are not specifically designed for Military, Aviation, Aerospace, Life-dependant Medical applications or any application requiring high reliability where component failure could result in loss of life and/or property. For applications requiring high reliability and/or presenting an extreme operating environment, written consent and authorization from Abracon Corporation is required. Please contact Abracon Corporation for more information.

ABRACON IS
ISO 9001:2008
CERTIFIED

ABRACON
CORPORATION

Visit www.abracon.com for Terms & Conditions of Sale
30332 Esperanza, Rancho Santa Margarita, California 92688
tel 949-546-8000 | fax 949-546-8001 | www.abracon.com

Revised: 10.11.12

X-ON Electronics

Largest Supplier of Electrical and Electronic Components

Click to view similar products for [Fixed Inductors](#) category:

Click to view products by [ABRACON](#) manufacturer:

Other Similar products are found below :

[CR43NP-680KC](#) [CR54NP-820KC](#) [CR54NP-8R5MC](#) [CTX32CT-100](#) [70F224AI](#) [MGDQ4-00004-P](#) [MHL1ECTTP18NJ](#) [MHL1JCTTD12NJ](#)
[PE-51506NL](#) [PE-53601NL](#) [PE-53602NL](#) [PE-53630NL](#) [PE-53824SNLT](#) [PE-62892NL](#) [PE-92100NL](#) [PG0434.801NLT](#) [PG0936.113NLT](#)
[9310-16](#) [PM06-2N7](#) [PM06-39NJ](#) [A01TK](#) [1206CS-471XJ](#) [HC2-2R2TR](#) [HC2LP-R47-R](#) [HC3-2R2-R](#) [HCF1305-3R3-R](#) [1206CS-151XG](#)
[RCH664NP-140L](#) [RCH664NP-4R7M](#) [RCH8011NP-221L](#) [RCP1317NP-332L](#) [RCP1317NP-391L](#) [RCR1010NP-470M](#) [RCR110DNP-331L](#)
[DH2280-4R7M](#) [DS1608C-106](#) [ASPI-4020HI-R10M-T](#) [B10TJ](#) [B82477P4333M](#) [B82498B3101J000](#) [B82498B3680J000](#) [ELJ-RE27NJF2](#)
[1812CS-153XJ](#) [1812CS-183XJ](#) [1812CS-223XJ](#) [1812LS-104XJ](#) [1812LS-105XJ](#) [1812LS-124XJ](#) [1812LS-154XJ](#) [1812LS-223XJ](#)