

SMD MOLDED WOUND CHIP INDUCTORS

AISM-1210

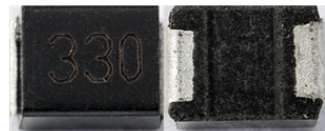

RoHS/RoHS II Compliant



3.2 x 2.5 x 2.2mm

FEATURES:

- High current rating coupled with high Q
- Exceptionally reliable over wide operating temperature and under humid environment
- Resilient to mechanical shocks
- Terminals constructed to withstand excessive pulling force
- Suitable for RoHS compliant reflow soldering

APPLICATIONS:

- VCRs, Video Cameras
- LCD TVs, portable VCRs
- Computer Products & Peripherals

ELECTRICAL SPECIFICATIONS:

PARAMETERS

ABRACON P/N:	AISM-1210-xxx Series
Operating temperature :	-40°C to + 85°C
Storage temperature :	+5°C to +40°C, Humidity < 70%RH

Part No. AISM-1210-Inductance Code	L(μH)	Tolerance	Q	Test Freq.	SRF(MHz)	DCR(Ω)	I _{dc} (mA)
			(min)	(MHz)	(min)	(max)	(max)
AISM-1210-10N	0.010	J, K, M	15	100	2500	0.13	450
AISM-1210-12N	0.012	J, K, M	17	100	2300	0.14	450
AISM-1210-15N	0.015	J, K, M	19	100	2100	0.16	450
AISM-1210-18N	0.018	J, K, M	21	100	1900	0.18	450
AISM-1210-22N	0.022	J, K, M	23	100	1700	0.20	450
AISM-1210-27N	0.027	J, K, M	23	100	1500	0.22	450
AISM-1210-33N	0.033	J, K, M	25	100	1400	0.24	450
AISM-1210-39N	0.039	J, K, M	25	100	1300	0.27	450
AISM-1210-47N	0.047	J, K, M	26	100	1200	0.30	450
AISM-1210-56N	0.056	J, K, M	26	100	1100	0.33	450
AISM-1210-68N	0.068	J, K, M	27	100	1000	0.36	450
AISM-1210-82N	0.082	J, K, M	27	100	900	0.40	450
AISM-1210-R10	0.10	J, K, M	28	100	700	0.44	450
AISM-1210-R12	0.12	J, K, M	30	25.2	500	0.22	450
AISM-1210-R15	0.15	J, K, M	30	25.2	450	0.25	450
AISM-1210-R18	0.18	J, K, M	30	25.2	400	0.28	450
AISM-1210-R22	0.22	J, K, M	30	25.2	350	0.32	450
AISM-1210-R27	0.27	J, K, M	30	25.2	320	0.36	450
AISM-1210-R33	0.33	J, K, M	30	25.2	300	0.40	450
AISM-1210-R39	0.39	J, K, M	30	25.2	250	0.45	450
AISM-1210-R47	0.47	J, K, M	30	25.2	220	0.50	450
AISM-1210-R56	0.56	J, K, M	30	25.2	180	0.55	450
AISM-1210-R68	0.68	J, K, M	30	25.2	160	0.60	450
AISM-1210-R82	0.82	J, K, M	30	25.2	140	0.65	450
AISM-1210-1R0	1.0	J, K, M	30	7.96	120	0.70	400
AISM-1210-1R2	1.2	J, K, M	30	7.96	100	0.75	390
AISM-1210-1R5	1.5	J, K, M	30	7.96	85	0.85	370
AISM-1210-1R8	1.8	J, K, M	30	7.96	80	0.90	350
AISM-1210-2R2	2.2	J, K, M	30	7.96	75	1.00	320
AISM-1210-2R7	2.7	J, K, M	30	7.96	70	1.10	290
AISM-1210-3R3	3.3	J, K, M	30	7.96	60	1.20	260
AISM-1210-3R9	3.9	J, K, M	30	7.96	55	1.30	250
AISM-1210-4R7	4.7	J, K, M	30	7.96	50	1.50	220
AISM-1210-5R6	5.6	J, K, M	30	7.96	45	1.60	200
AISM-1210-6R8	6.8	J, K, M	30	7.96	40	1.80	180
AISM-1210-8R2	8.2	J, K, M	30	7.96	35	2.0	170
AISM-1210-100	10	J, K, M	30	2.52	30	2.1	150
AISM-1210-120	12	J, K, M	30	2.52	20	2.5	140
AISM-1210-150	15	J, K, M	30	2.52	20	2.8	130



SMD MOLDED WOUND CHIP INDUCTORS



3.2 x 2.5 x 2.2mm

AIMS-1210

RoHS/RoHS II Compliant

Part No. AIMS-1210-Inductance Code	L(μH)	Tolerance	Q	Test Freq.	SRF(MHz)	DCR(Ω)	Idc(mA)
		(%)	(min)	(MHz)	(min)	(max)	(max)
AIMS-1210-180	18	J, K, M	30	2.52	20	3.3	120
AIMS-1210-220	22	J, K, M	30	2.52	20	3.7	110
AIMS-1210-270	27	J, K, M	30	2.52	18	5.0	80
AIMS-1210-330	33	J, K, M	30	2.52	17	5.6	70
AIMS-1210-390	39	J, K, M	30	2.52	16	6.4	65
AIMS-1210-470	47	J, K, M	30	2.52	15	7.0	60
AIMS-1210-560	56	J, K, M	30	2.52	13	8.0	55
AIMS-1210-680	68	J, K, M	30	2.52	12	9.0	50
AIMS-1210-820	82	J, K, M	30	2.52	11	10	45
AIMS-1210-101	100	J, K, M	20	0.796	10	10	40
AIMS-1210-121	120	J, K, M	20	0.796	9	11	70
AIMS-1210-151	150	J, K, M	20	0.796	7	15	65
AIMS-1210-181	180	J, K, M	20	0.796	7	17	60
AIMS-1210-221	220	J, K, M	20	0.796	6	21	50
AIMS-1210-271	270	J, K, M	20	0.796	5	28	45
AIMS-1210-331	330	J, K, M	20	0.796	5	34	40

Test Conditions

Isat: $\Delta L/L$ (initial) \geq -10%

PART NUMBER IDENTIFICATION

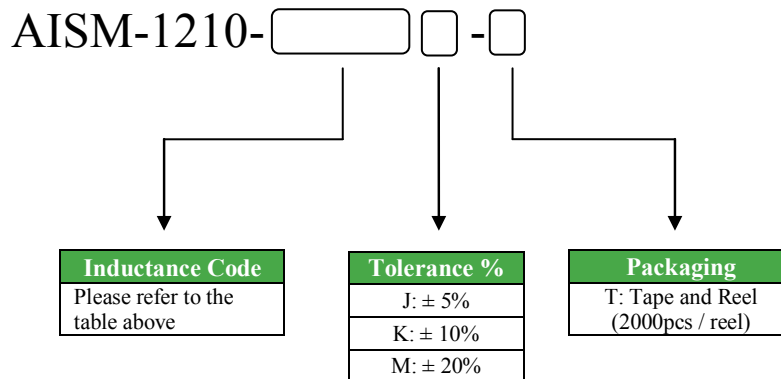

OUTLINE DIMENSIONS:

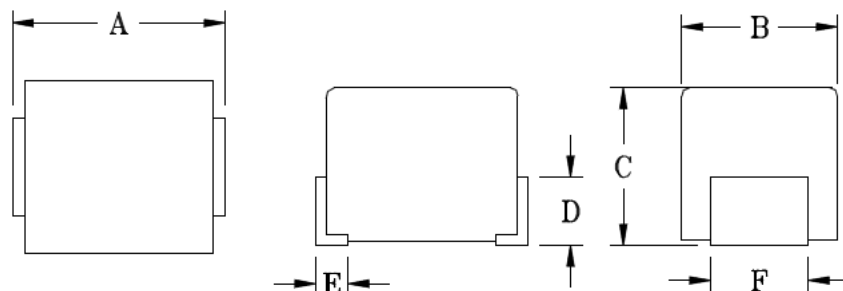

Recommended Land Pattern

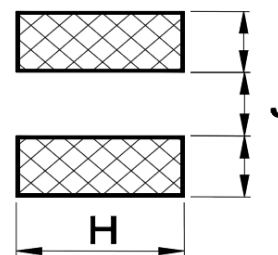

A	B	C	D	E	F	I	J	H
3.2 \pm 0.3	2.5 \pm 0.2	2.2 \pm 0.2	0.6 ref	0.2 min	1.9 \pm 0.1	1.2	2.0	2.0

Dimension: mm

SMD MOLDED WOUND CHIP INDUCTORS



3.2 x 2.5 x 2.2mm

AIMS-1210

RoHS/RoHS II Compliant

REFLOW PROFILE:

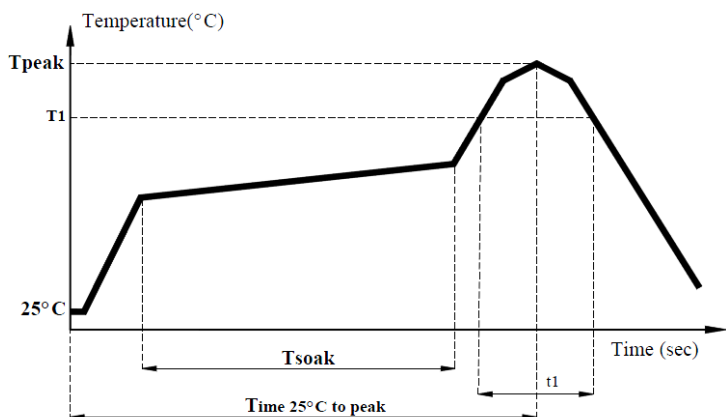

Item	mark	
Temperature rise gradient		3°C /sec (max)
Heating time	Tsoak	50s ~ 150s
Heating temperature		120°C~180°C
Time maintained above: -Temperature (T1) -Time(t1)	T1/t1	217°C/60 sec max
Peak temperature	Tpeak	250 max.
Time 25°C to peak		6 minutes max.

TAPE & REEL::

T: 2,000pcs / reel

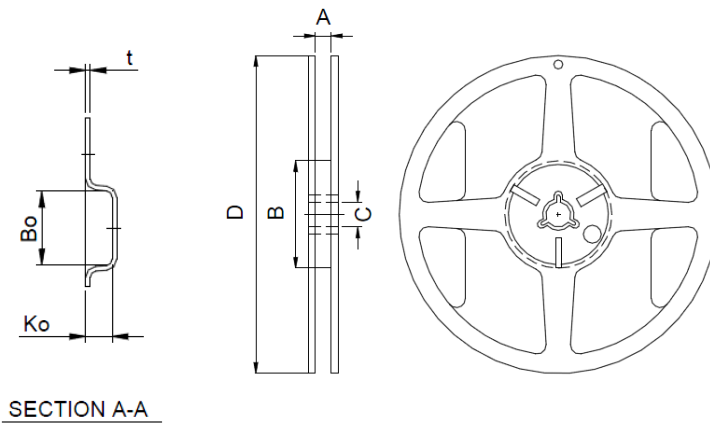
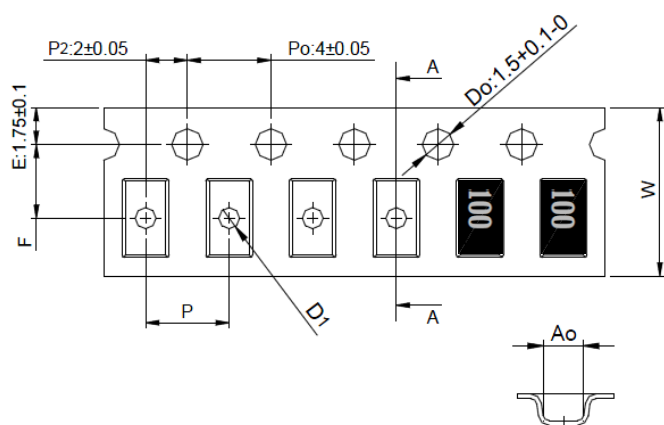

A0	B0	K0	P	F	W	t	A	B	C	D
2.88 ± 0.1	3.65 ± 0.1	2.5 ± 0.1	4 ± 0.1	3.5 ± 0.05	8 ± 0.2	0.25 ± 0.05	9.0 ± 0.5	60 ± 2.0	13.5 ± 0.5	178 ± 2.0

Dimension: mm

ATTENTION: Abracon Corporation's products are COTS – Commercial-Off-The-Shelf products; suitable for Commercial, Industrial and, where designated, Automotive Applications. Abracon's products are not specifically designed for Military, Aviation, Aerospace, Life-dependant Medical applications or any application requiring high reliability where component failure could result in loss of life and/or property. For applications requiring high reliability and/or presenting an extreme operating environment, written consent and authorization from Abracon Corporation is required. Please contact Abracon Corporation for more information.

ABRACON IS
ISO 9001:2008
CERTIFIED



Visit www.abracon.com for Terms & Conditions of Sale **Revised: 10.04.13**
30332 Esperanza, Rancho Santa Margarita, California 92688
tel 949-546-8000| fax 949-546-8001| www.abracon.com

X-ON Electronics

Largest Supplier of Electrical and Electronic Components

Click to view similar products for [Fixed Inductors](#) category:

Click to view products by [Abracon](#) manufacturer:

Other Similar products are found below :

[CR43NP-680KC](#) [CR54NP-820KC](#) [CR54NP-8R5MC](#) [CTX32CT-100](#) [70F224AI](#) [MGDQ4-00004-P](#) [MHL1ECTTP18NJ](#) [MHL1JCTTD12NJ](#)
[PE-51506NL](#) [PE-53601NL](#) [PE-53602NL](#) [PE-53630NL](#) [PE-53824SNLT](#) [PE-62892NL](#) [PE-92100NL](#) [PG0434.801NLT](#) [PG0936.113NLT](#)
[9310-16](#) [PM06-2N7](#) [PM06-39NJ](#) [A01TK](#) [1206CS-471XJ](#) [HC2-2R2TR](#) [HC2LP-R47-R](#) [HC3-2R2-R](#) [HCF1305-3R3-R](#) [1206CS-151XG](#)
[RCH664NP-140L](#) [RCH664NP-4R7M](#) [RCH8011NP-221L](#) [RCP1317NP-332L](#) [RCP1317NP-391L](#) [RCR1010NP-470M](#) [RCR110DNP-331L](#)
[DH2280-4R7M](#) [DS1608C-106](#) [ASPI-4020HI-R10M-T](#) [B10TJ](#) [B82477P4333M](#) [B82498B3101J000](#) [B82498B3680J000](#) [ELJ-RE27NJF2](#)
[1812CS-153XJ](#) [1812CS-183XJ](#) [1812CS-223XJ](#) [1812LS-104XJ](#) [1812LS-105XJ](#) [1812LS-124XJ](#) [1812LS-154XJ](#) [1812LS-223XJ](#)