

Surface Mount WLAN / Bluetooth Chip Antenna (2450MHz)

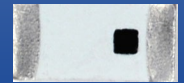

AMCA31-2R450G-S1F-T3



3.2 x 1.6 x 1.2mm
RoHS/RoHS II Compliant
MSL = 1

Features

- 2450MHz, Bandwidth ≥ 90 MHz
- Suitable for RoHS compliant reflow
- Gain 0.5dBi (Peak) / -1dBi (Average)
- VSWR $< 2:1$
- Small size – 3.2 x 1.6 x 1.2mm (0.125 x 0.62 x 0.047 inch)
- Non Ground Mounting type.
- Power Handling 3W Max
- Matched to 50 Ohm.

Applications

- Wireless application - Bluetooth / WiFi (2.445GHz)
- High density applications
- Bluetooth headsets or ear pieces
- Computer mouse and keyboards
- PROFINET – Industrial automation
- Video Game systems
- Alternative to larger PCB solution

Electrical Specifications

Parameter	Min.	Typ.	Max.	Units	Note
Frequency		2450		MHz	
Bandwidth	100			MHz	
Peak Gain		0.5		dBi	
Average Gain		-1		dBi	
VSWR			2		
Impedance		50		Ω	
Power Capability			3	W	

Environmental Characteristics

Parameters	Specification
Environmental friendly	Pb-free
MSL	1
Operating Temperature	-40 °C to + 85 °C
Storage Temperature	-10 °C to +40 °C
Relative Humidity	70%

Surface Mount WLAN / Bluetooth Chip Antenna (2450MHz)

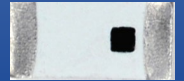

AMCA31-2R450G-S1F-T3



3.2 x 1.6 x 1.2mm
RoHS/RoHS II Compliant
MSL = 1

Product Dimensions and PCB Land Drawing (Unit: mm)

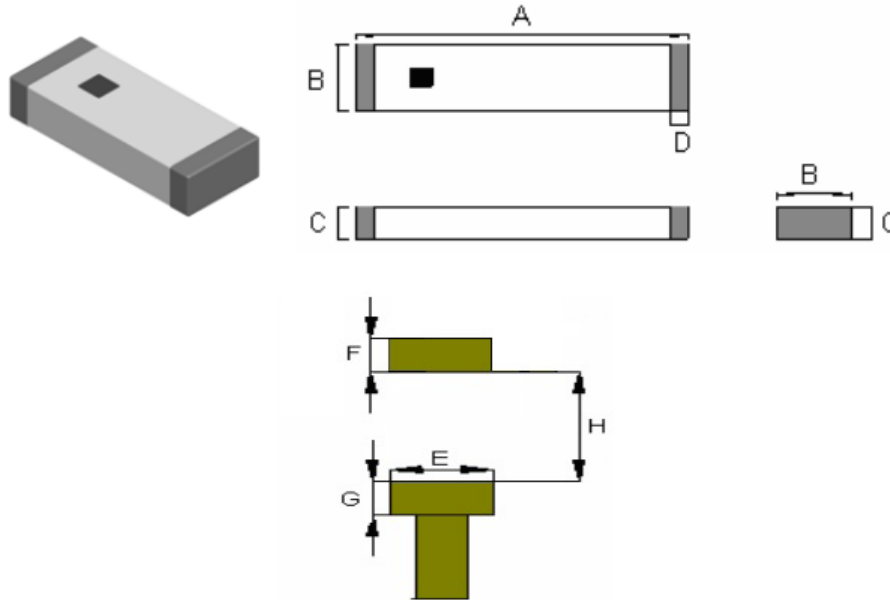

This is the feed-line to the Antenna and should be matched to 50 Ohms based upon the PCB dielectric parameters.

Series	A	B	C	D	E	F	G	H
AMCA31	3.2±0.2	1.6±0.2	1.2±0.2	0.5±0.2	1.6±0.2	0.8±0.2	0.8±0.2	2.6±0.2

Terminal Configurations



No.	Terminal Name	No.	Terminal Name
Pad 1	Feed Point	Pad 2	NC

Surface Mount WLAN / Bluetooth Chip Antenna (2450MHz)

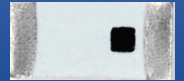

AMCA31-2R450G-S1F-T3



3.2 x 1.6 x 1.2mm
RoHS/RoHS II Compliant
MSL = 1

Application Test Circuit & PCB layouts – Default Layouts

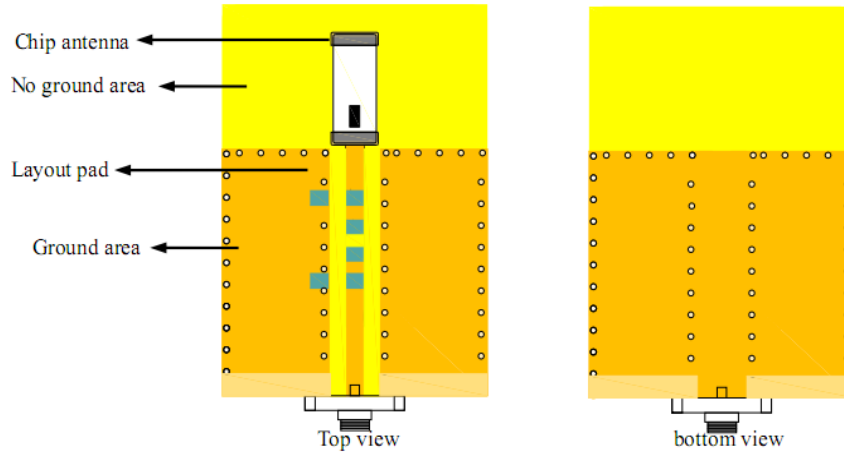
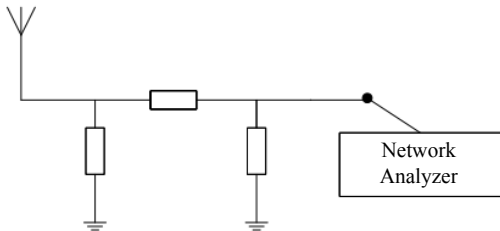

Figure shows the PCB layout highlighting the Ground and No Ground areas and trace feed line to the chip antenna.

Matching Circuit and Reference Values

Electrical Performance with matching circuit:



Component	Description	Value
Antenna	AMCA31-2R450G-S1F-T3	----
Capacitor	*Series C	0.5 ~ 10 pF
	*Shunt C	33pF, 100 pF
Inductor	Series L	1.0 ~ 6nH
	Shunt L	1.0 ~ 6nH

Passive Test with Network Analyzer

*Series: Connected between antenna and feeding line in series.

*Shunt: Connected between antenna and feeding line in parallel

Note: Recommendation is to pre-place the π -type circuit layout circuit which will offer full flexibility to match the antenna to 50 Ohm in the final product layout with one of the match configurations below. Depending on matching, NC will apply to certain components.

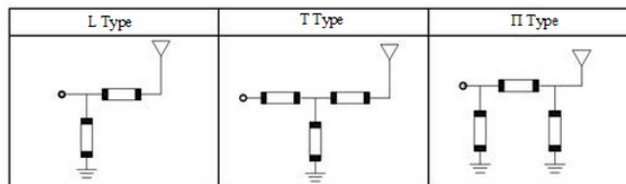

Surface Mount WLAN / Bluetooth Chip Antenna (2450MHz)



AMCA31-2R450G-S1F-T3



3.2 x 1.6 x 1.2mm
RoHS/RoHS II Compliant
MSL = 1

Matching Circuit on Evaluation Board

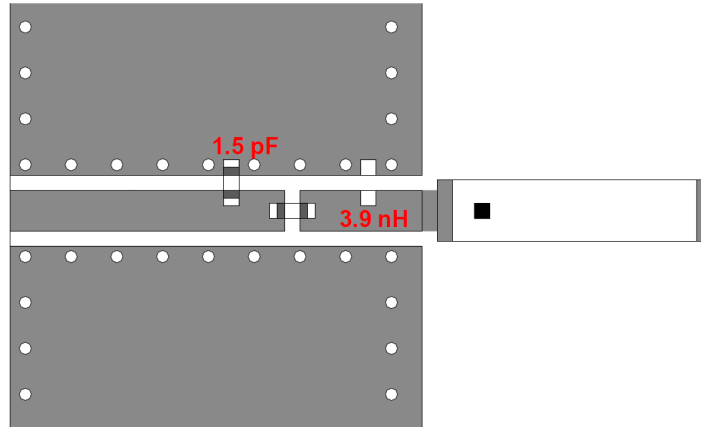

- Line width should be designed to match 50 Ω characteristic impedance, depending on PCB material and thickness.
- The component values given above will vary based on the PCB layout

Return Loss, VSWR and Impedance Characteristics

Before Matching

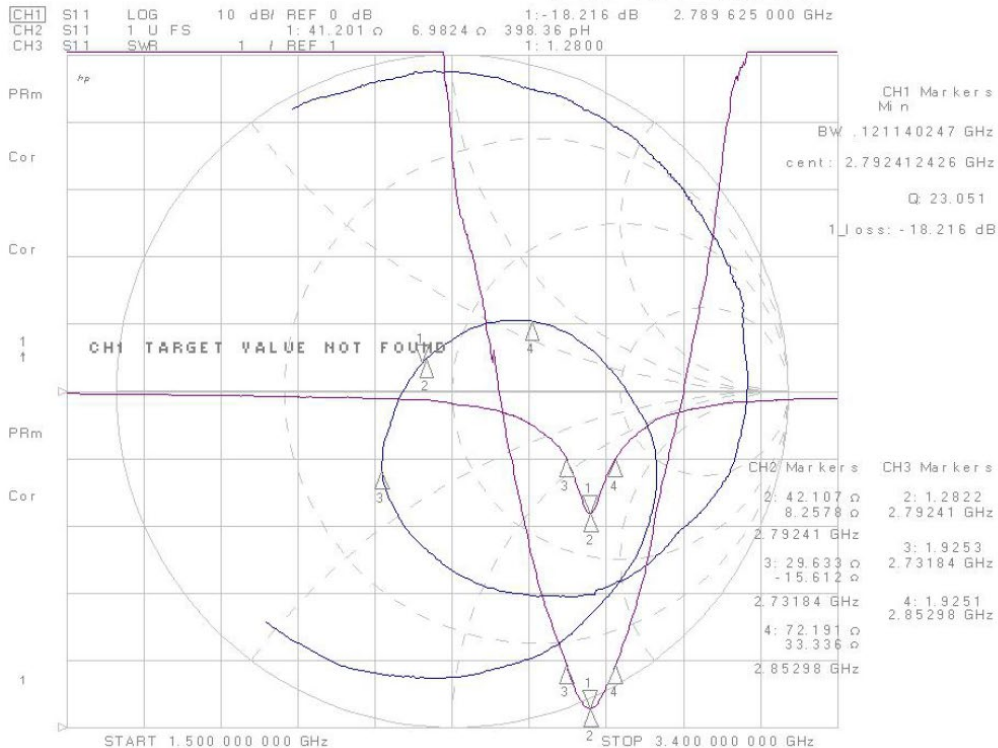

Surface Mount WLAN / Bluetooth Chip Antenna (2450MHz)



AMCA31-2R450G-S1F-T3



3.2 x 1.6 x 1.2mm
RoHS/RoHS II Compliant
MSL = 1

Return Loss, VSWR and Impedance Characteristics Cont.

After Matching

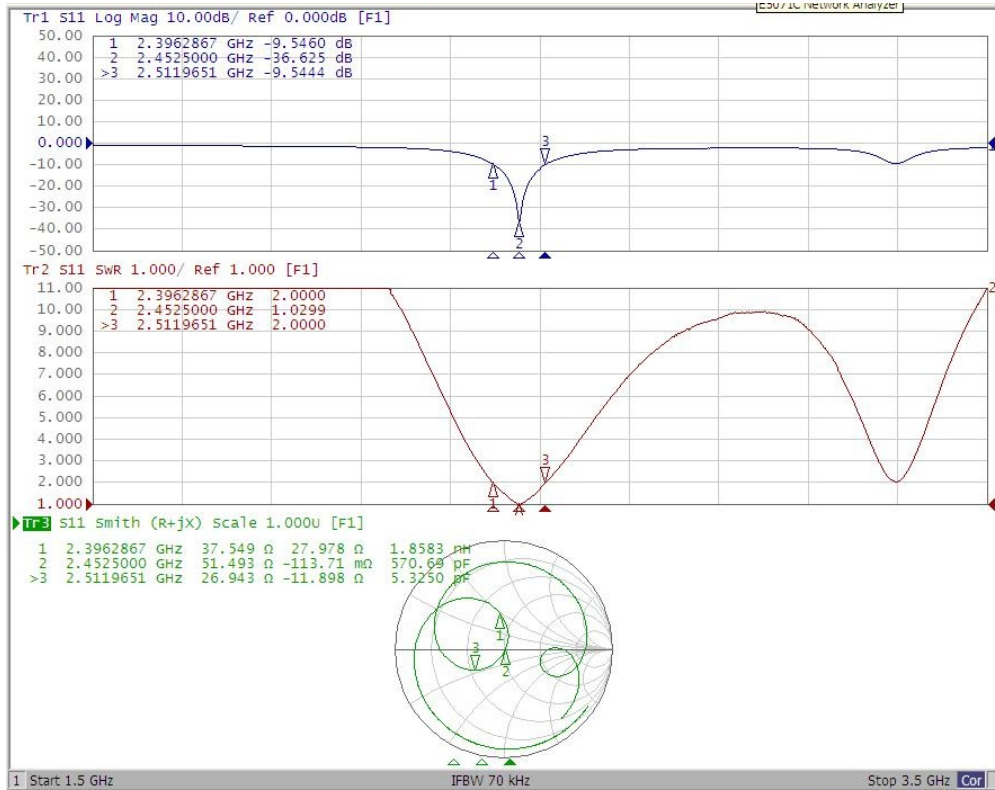

Radiation Pattern and Gain

Test Setup

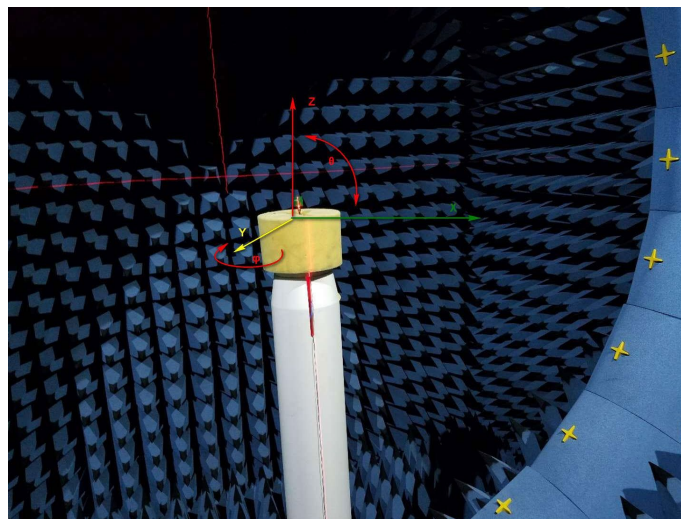

Surface Mount WLAN / Bluetooth Chip Antenna (2450MHz)

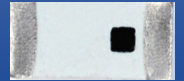

AMCA31-2R450G-S1F-T3



3.2 x 1.6 x 1.2mm
RoHS/RoHS II Compliant
MSL = 1

Radiation Pattern and Gain

XY Plane

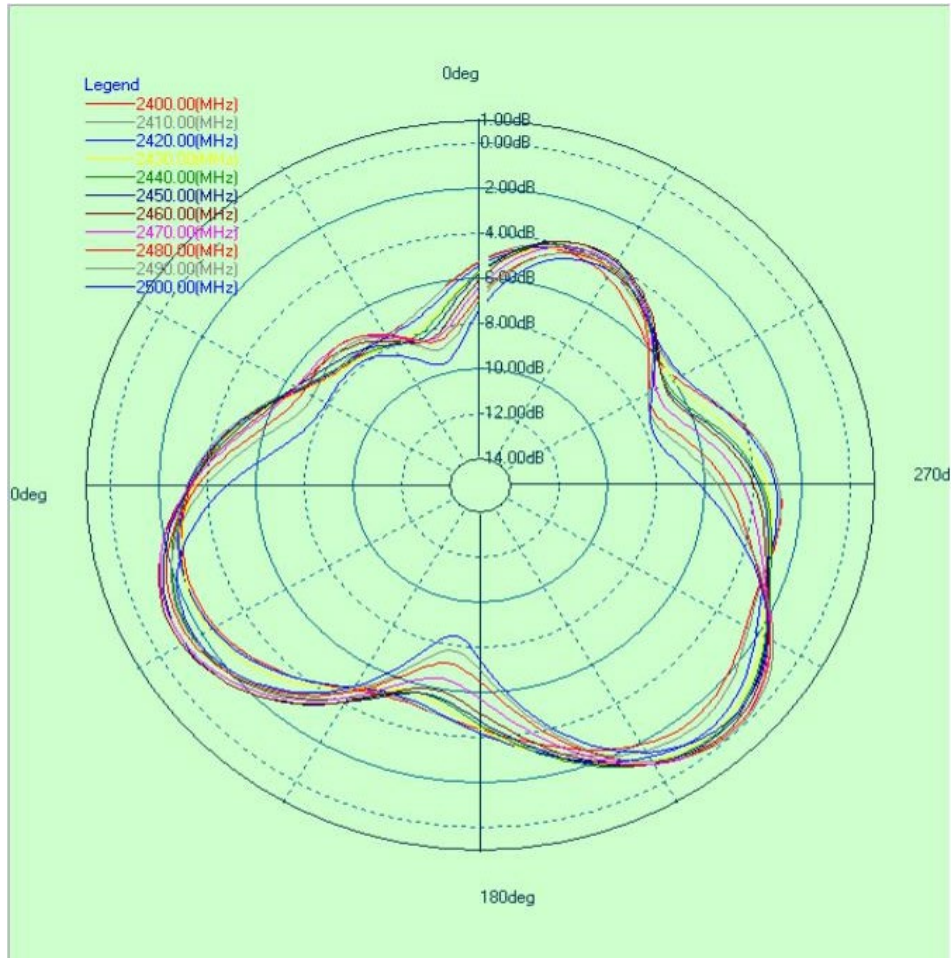

Surface Mount WLAN / Bluetooth Chip Antenna (2450MHz)



AMCA31-2R450G-S1F-T3



3.2 x 1.6 x 1.2mm
RoHS/RoHS II Compliant
MSL = 1

Radiation Pattern and Gain

XZ Plane

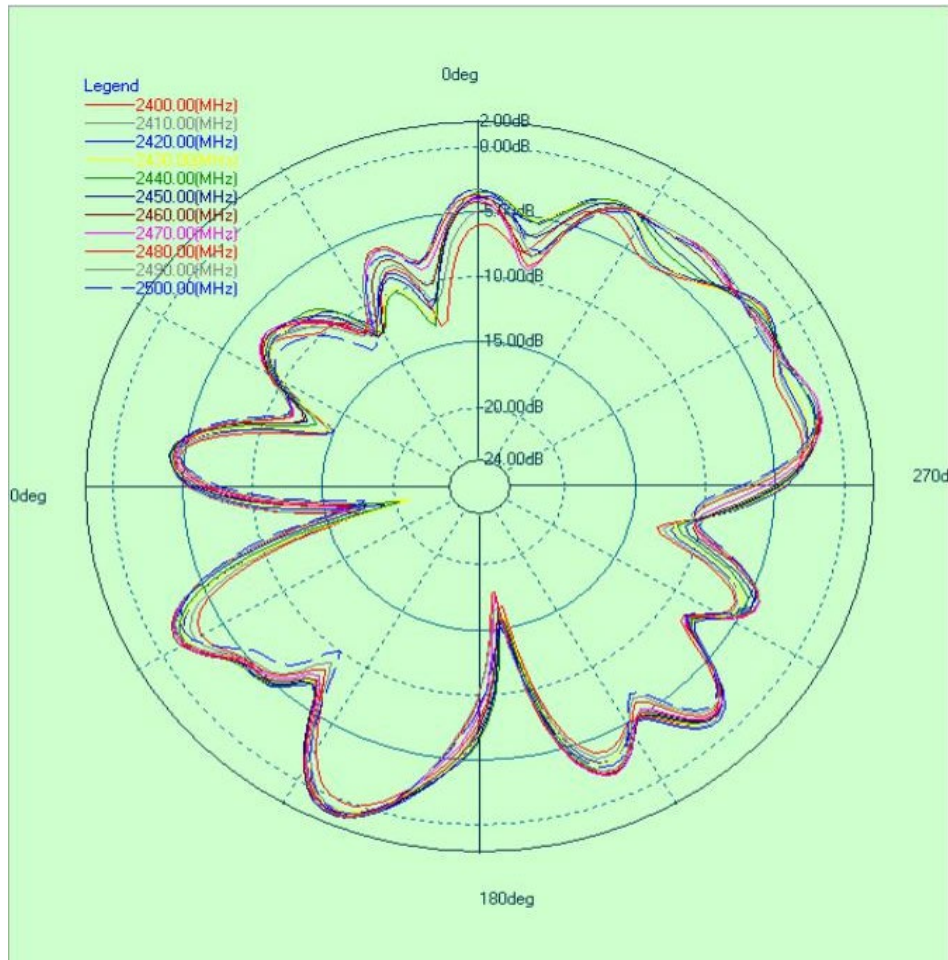

Surface Mount WLAN / Bluetooth Chip Antenna (2450MHz)

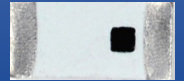

AMCA31-2R450G-S1F-T3



3.2 x 1.6 x 1.2mm
RoHS/RoHS II Compliant
MSL = 1

Radiation Pattern and Gain

YZ Plane

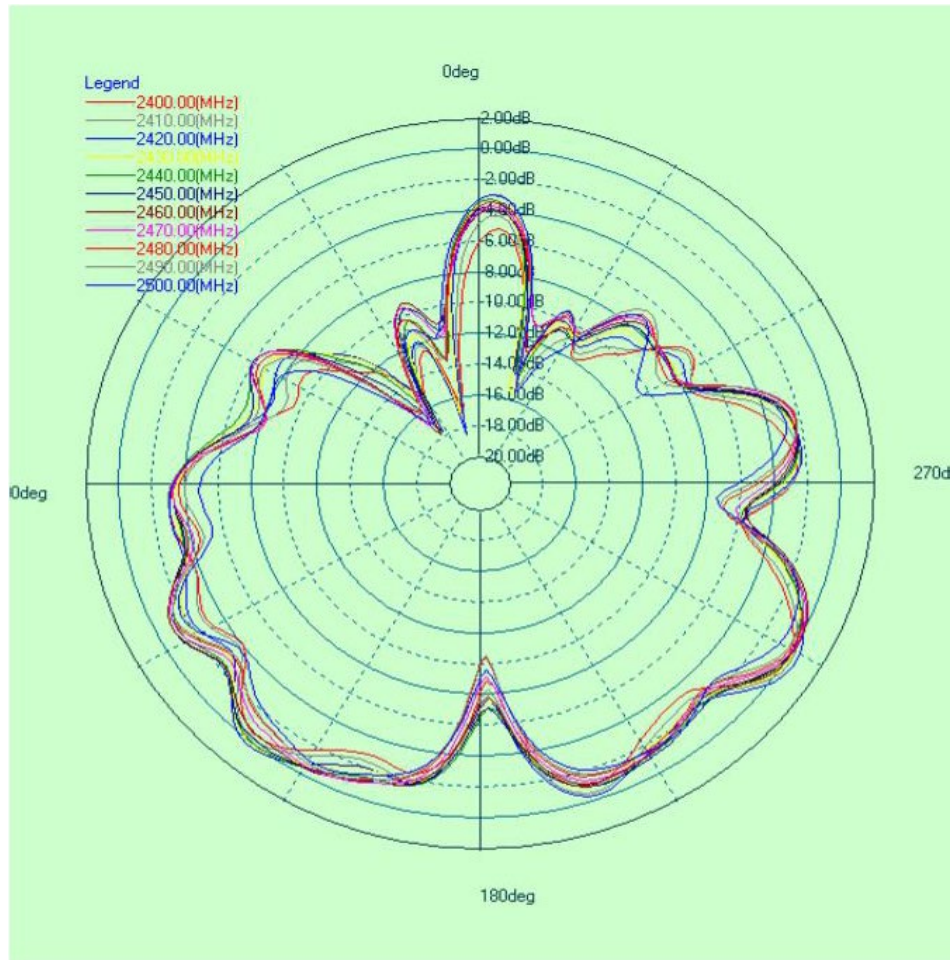

Surface Mount WLAN / Bluetooth Chip Antenna (2450MHz)

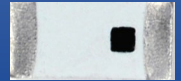

AMCA31-2R450G-S1F-T3



3.2 x 1.6 x 1.2mm
RoHS/RoHS II Compliant
MSL = 1

Radiation Pattern and Gain

3D – Pattern | (2400 MHz, 2450 MHz, 2500 MHz)

Gain

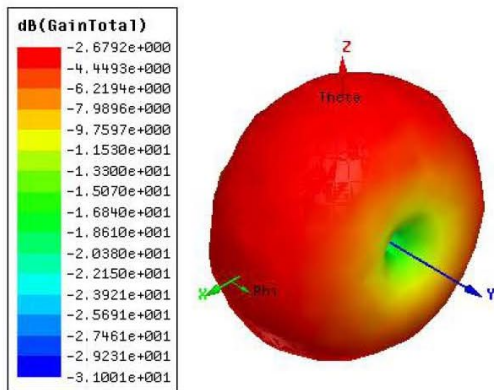
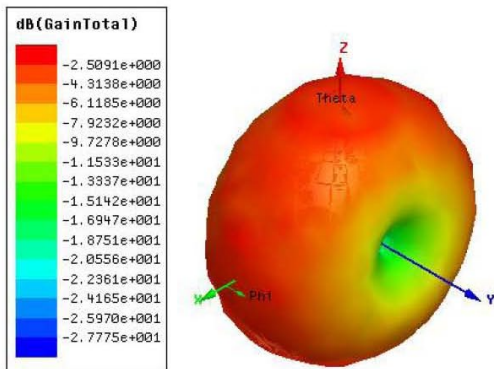
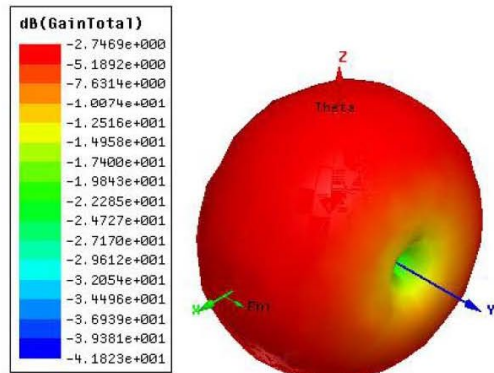

Frequency (MHz)	Gain (dBi)
2400	-4.125434820
2410	-4.180958401
2420	-3.877599807
2430	-3.930632294
2440	-3.676540694
2450	-3.582882743
2460	-3.534294730
2470	-3.598055402
2480	-3.690017588
2490	-3.876259790
2500	-3.918544199

Surface Mount WLAN / Bluetooth Chip Antenna (2450MHz)

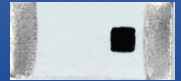

AMCA31-2R450G-S1F-T3



3.2 x 1.6 x 1.2mm
RoHS/RoHS II Compliant
MSL = 1

Packaging

T3=3000 Units per reel

Tape Dimensions (Unit: mm)

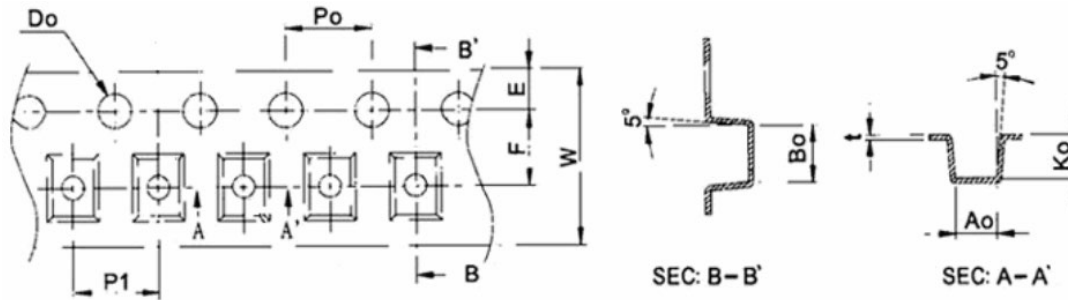

W	8.00±0.10	D0	1.50 +0.10 / -0.0
P1	4.00±0.10	P0	4.00±0.10
E	1.75±0.10	K0	1.50±0.10
F	3.50±0.15	A0	1.80±0.10
B0	3.50±0.10	t	0.22±0.05

Reel Dimensions (Unit: mm)

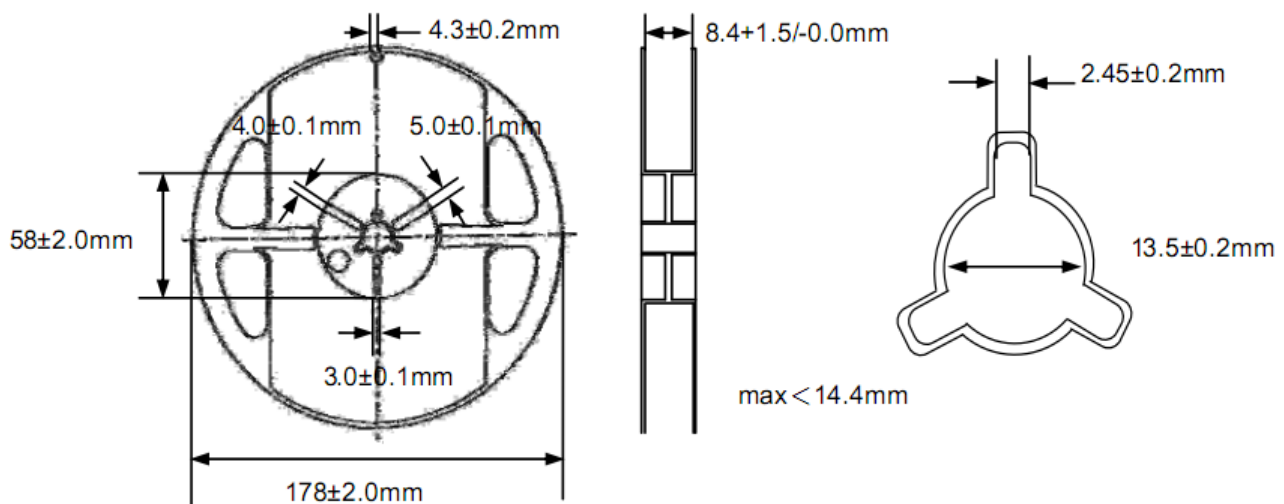

Surface Mount WLAN / Bluetooth Chip Antenna (2450MHz)

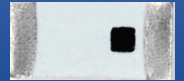

AMCA31-2R450G-S1F-T3



3.2 x 1.6 x 1.2mm
RoHS/RoHS II Compliant
MSL = 1

Packaging

Tape Drawing

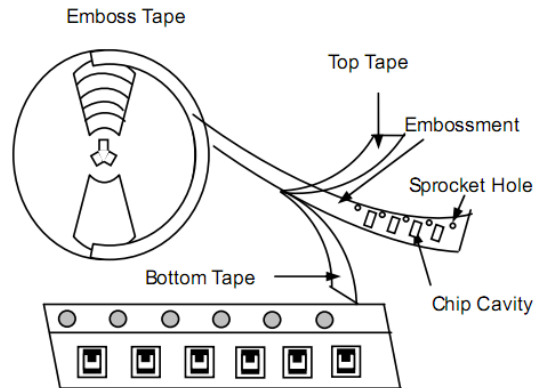

Note: The sprocket holes are to the right as the tape is pulled toward the user.

Reflow Profile

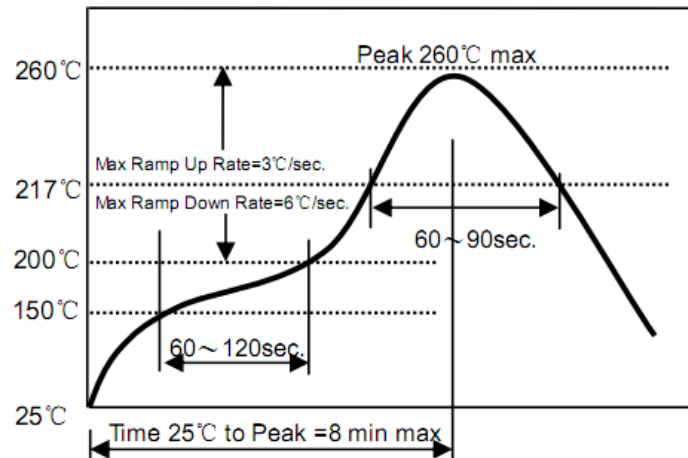

- Preheat condition: 150 ~200 °C / 60~120 sec
- Allowed time above 217 °C : 60~90sec
- Max temp: 260 °C
- Max time at max temp: 10 sec
- Solder paste: Sn/3.0Ag/0.5Cu
- Allowed Reflow time: 2x max

[Note: The reflow profile in the above table is only for qualification and is not meant to specify board assembly profiles. Actual board assembly profiles must be based on the customer's specific board design, solder paste and process, and should not exceed the parameters as the Reflow profile shows.]

Surface Mount WLAN / Bluetooth Chip Antenna (2450MHz)

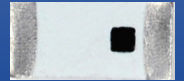

AMCA31-2R450G-S1F-T3



3.2 x 1.6 x 1.2mm
RoHS/RoHS II Compliant
MSL = 1

Manual Soldering

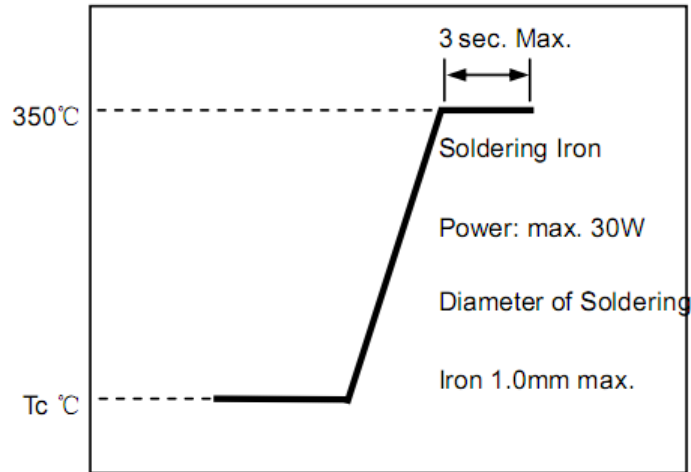

- Iron soldering power: Max.30 W
- Pre-heating: 150 °C / 60 sec
- Soldering Tip temperature: 350 °C max.
- Soldering time: 3 sec Max.
- Solder paste: Sn/3.0Ag/0.5Cu
- Max. 1 time for iron soldering

[Note: Take care not to apply the tip of the soldering iron to the terminal electrodes.]

ATTENTION: Abracon LLC's products are COTS – Commercial-Off-The-Shelf products; suitable for Commercial, Industrial and, where designated, Automotive Applications. Abracon's products are not specifically designed for Military, Aviation, Aerospace, Life-dependent Medical applications or any application requiring high reliability where component failure could result in loss of life and/or property. For applications requiring high reliability and/or presenting an extreme operating environment, written consent and authorization from Abracon LLC is required. Please contact Abracon LLC for more information.



5101 Hidden Creek Ln Spicewood TX 78669
Phone: 512-371-6159 | Fax: 512-351-8858
For terms and conditions of sales, please visit:
www.abracon.com

REVISED: 03-21-19

ABRACON IS
ISO9001-2015
CERTIFIED

X-ON Electronics

Largest Supplier of Electrical and Electronic Components

Click to view similar products for [Antennas](#) category:

Click to view products by [ABRACON](#) manufacturer:

Other Similar products are found below :

[GAN30084EU](#) [930-033-R](#) [GW17.07.0250E](#) [1513563-1](#) [EXE902SM](#) [APAMPG-117](#) [MAF94383](#) [W3908B0100](#) [W6102B0100](#) [YE572113-30RSMM](#) [108-00014-50](#) [66089-2406](#) [A09-F8NF-M](#) [A09-F5NF-M](#) [RGFRA1903041A1T](#) [W3593B0100](#) [W3921B0100](#) [SIMNA-868](#) [SIMNA-915](#) [SIMNA-433](#) [W1044](#) [W1049B090](#) [A75-001](#) [WTL2449CQ1-FRSMM](#) [CPL9C](#) [EXB148BN](#) [0600-00060](#) [TRA9020S3PBN-001](#) [GD5W-28P-NF](#) [MA9-7N](#) [GD53-25](#) [GD5W-21P-NF](#) [EXB144SM](#) [C37](#) [MAF94051](#) [GD35-17P-NF](#) [P1744](#) [MA9-5N](#) [EXD420PL](#) [B1322NR](#) [QWFTB120](#) [MAF94271](#) [MAF94300](#) [GPSMB301](#) [FG4403](#) [AO-AGSM-OM54](#) [5200232](#) [MIKROE-2349](#) [WCM.01.0111](#) [MIKROE-2393](#)