

Surface Mount WCS/WiMAX/LTE Antenna (2350MHz)

AMCA52-2R350G-S1F-T



RoHS / RoHS II Compliant



5.2 x 2.1 x 1.1mm

Moisture Sensitivity Level (MSL) – MSL = 1

FEATURES:

- 2350MHz, Bandwidth ≥ 150 MHz
- Suitable for RoHS compliant reflow
- Gain 2.5dBi (Peak) / 0.5dBi (Average)
- VSWR $< 2:1$
- Small size – 5.2 x 2.1 x 1.1mm (0.204 x 0.082 x 0.039inch)
- Non Ground Mounting type.
- Power Handling 3W Max
- Matched to 50 Ohm.

APPLICATIONS:

- Wireless application - WCS Band, LTE Band 40, and WiMax bands.
- User Equipments (UE), e.g. dongles, modems
- WCS Band supporting Fixed, Mobile, Computing, Cellular Telephone, Radiolocation, and Satellite Communications.
- User Equipments (EU) covering 2300MHz LTE TDD (Band 40)
- Alternative to larger PCB solution

STANDARD SPECIFICATIONS

Maximum Ratings

Item	Value
Operating Temperature Range	-40°C to + 85°C
Storage Temperature Range	-10°C ~ +40 and RH °C 70% (Max.)

Electrical Characteristics

Item	Spec
Frequency	2350MHz
Bandwidth	≥ 150 MHz
Peak Gain	2.5 dBi typ.
Average Gain	0.5 dBi typ
VSWR	$< 2:1$
Impedance	50 Ohm
Power Capability	3W max

PART IDENTIFICATION:

AMCA52-2R350G-S1F-T4

Packaging

Blank: Bulk or Cut Tape
T4 : T/R 4000pcs per reel

Surface Mount WLAN Antenna (2350MHz)

AMCA52-2R350G-S1F-T



RoHS / RoHS II Compliant



5.2 x 2.1 x 1.1mm

OUTLINE DIMENSIONS:

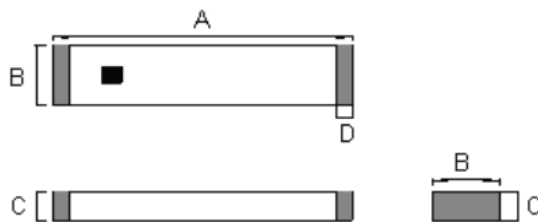
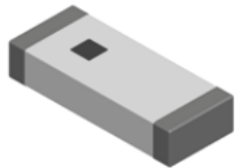

Recommended Land Pattern

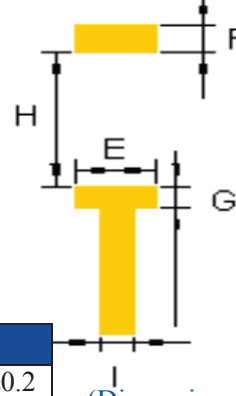

Series	A	B	C	D	E	F	G	H	I
AMCA52	5.2±0.2	2.1±0.2	1.1±0.2	0.5±0.2	2.0±0.2	1.5±0.2	1.0±0.2	4.0±0.2	1.4±0.2

(Dimensions: mm)

REFLOW PROFILE:

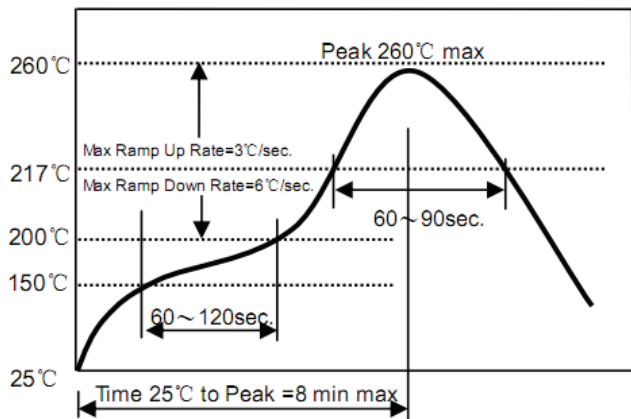

- Preheat condition: 150 ~200 /60~120°C sec.
- Allowed time above 217°C: 60~90sec.
- Max temp: 260°C
- Max time at max temp: 10sec.
- Solder paste: Sn/3.0Ag/0.5Cu
- Allowed Reflow time: 2x max

[Note: The reflow profile in the above table is only for qualification and is not meant to specify board assembly profiles. Actual board assembly profiles must be based on the customer's specific board design, solder paste and process, and should not exceed the parameters as the Reflow profile shows.]

MANUAL SOLDERING

Pre-heating Temperature: 120°C, 60°C ~ 300 sec.

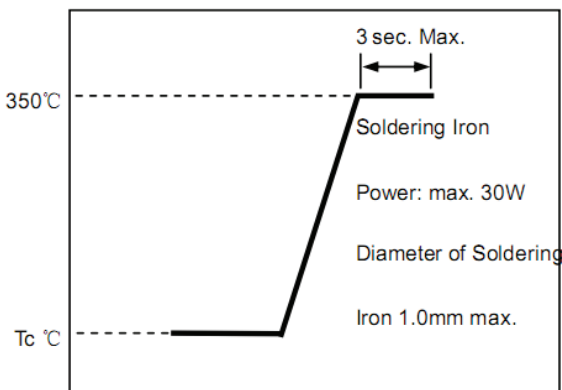

- Iron soldering power: Max.30W.
- Pre-heating: 150 / 60 sec. °C.
- Soldering Tip temperature: 350 Max. °C.
- Soldering time: 3 sec Max.
- Solder paste: Sn/3.0Ag/0.5Cu.
- Max 1 times for iron soldering.
- Soldering Temperature: 340°C±5°C, 5sec max per each terminal.

[Note: Take care not to apply the tip of the soldering iron to the terminal electrodes.]

Surface Mount WLAN Antenna (2350MHz)

AMCA52-2R350G-S1F-T

 RoHS / RoHS II Compliant



5.2 x 2.1 x 1.1mm

TAPE & REEL:

Packaging: 4000 Units per reel

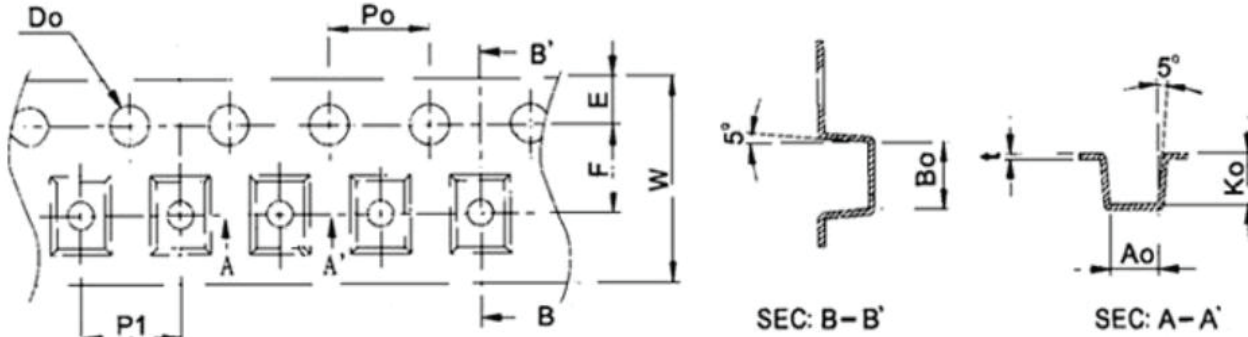

W	12.0±0.10	D0	1.50 +0.10 / - 0.0
P1	8.0±0.10	P0	4.0±0.10
E	1.75±0.10	K0	1.20±0.10
F	5.50±0.15	A0	2.35±0.10
B0	5.50±0.10	t	0.3±0.05

Reel Dimensions



Type	Spec	Dimensions (mm)			
		A	W	C	B
AMCA52	13"*12mm	330±1	12.5±0.2	100±0.5	2.3±0.2

Mounting Direction of Tape on Reel

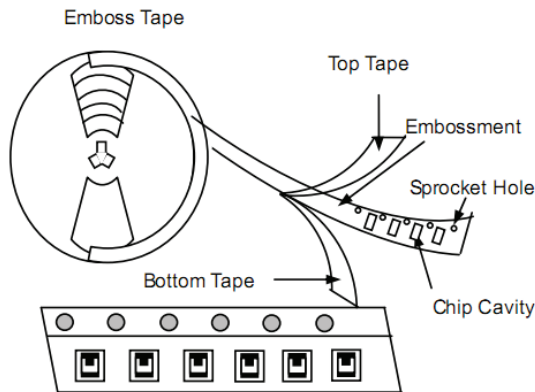

Note: The sprocket holes are to the right as the tape is pulled toward the user.

(Dimensions: mm)

ATTENTION: Abracon Corporation's products are COTS – Commercial-Off-The-Shelf products; suitable for Commercial, Industrial and, where designated, Automotive Applications. Abracon's products are not specifically designed for Military, Aviation, Aerospace, Life-dependant Medical applications or any application requiring high reliability where component failure could result in loss of life and/or property. For applications requiring high reliability and/or presenting an extreme operating environment, written consent and authorization from Abracon Corporation is required. Please contact Abracon Corporation for more information.

X-ON Electronics

Largest Supplier of Electrical and Electronic Components

Click to view similar products for [Antennas](#) category:

Click to view products by [ABRACON](#) manufacturer:

Other Similar products are found below :

[CCT FM1](#) [ABFT](#) [AD-NM-SMAF 001-0021](#) [CTC110](#) [MAF94149](#) [EXE902SF](#) [MMCX-SMA-100](#) [PDQ24496-91NF](#) [GAN30084EU](#) [930-033-R](#) [A08-HABUF-P5I](#) [AAF95035](#) [DG-ANT-20DP-BG-B](#) [APAMPGJ-141](#) [1513563-1](#) [OF86315-FNF](#) [OP24516DS-91NM](#) [A09-HASM-7](#) [EXE902MD](#) [EXE902SM](#) [SPDA17806/2170LAR](#) [APAMPG-117](#) [GPS1575SP26-004](#) [GPS15MGSMA](#) [CMD69273P-30NF](#) [CMQ69273-30NF](#) [RD2458-5-OTDR-NM](#) [RD2458-5-RSMA](#) [TRAB24/49003](#) [W4120ER5000](#) [W6102B0100](#) [YE572113-30RSMM](#) [108-00014-50](#) [SPDA17RP918](#) [OP24516SX-91NM](#) [OP24516SX-91RSMM](#) [CMQ69273P-30NF](#) [CMS69273-30NF](#) [CMS69273P-30NF](#) [TRAB24003N](#) [TRAB24003NP](#) [TRAB8213NP](#) [TRAB8903](#) [A09-Y8NF](#) [A09-Y11NF](#) [A09-HSM-7](#) [A09-F8NF-M](#) [A09-F5NF-M](#)