

MINI MOLDED POWER INDUCTOR

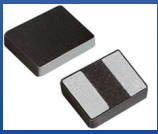

AOTA-B201208S

Request Samples



Check Inventory



2.0 x 1.2 x 0.8 mm
RoHS/RoHS II Compliant
MSL Level = 1

Features

- Shielded construction for minimized EMI.
- Low DCR (as low as 10mΩ) for better efficiency
- High current up to 11A handling capability
- Compact size that is suitable for high-density designs
- Excellent for high-frequency switching applications due to SRF up to 185MHz.

Applications

- Consumer electronics and portable devices
- Power electronics such as DC-DC converters, inverters and voltage regulators
- Industrial applications, robotics, signal conditioning, instrumentation and control systems
- IoT devices, smart home, automation systems and wireless sensing

Electrical Specifications

Part Number	Inductance	Tolerance	Self-Resonant Frequency	DC Resistance		Saturation Current		Temperature Rise Current	
	1MHz/1.0V		Min.	Typ	Max	Typ	Max	Typ	Max
Units	μH	%	MHz	mΩ		A		A	
Symbol	L	M	SRF	DCR		Isat		Irms	
AOTA-B201208SR11MT	0.11	20%	185	10	13	11	10	6.5	5.6
AOTA-B201208SR24MT	0.24	20%	130	16	19	7.2	6.5	6.0	5.4
AOTA-B201208SR33MT	0.33	20%	125	23	28	6.2	5.6	4.3	4.0
AOTA-B201208SR47MT	0.47	20%	96	22	25	4.8	4.5	4.4	4.0
AOTA-B201208S1R0MT	1.0	20%	60	46	50	3.5	3.3	3.5	3.2
AOTA-B201208S2R2MT	2.2	20%	42	120	130	2.1	1.9	2.0	1.8

Test Conditions

Isat: DC current at which the inductance drops 30% from its nominal value.

Irms: DC current that causes the temperature rise (ΔT , approximate 40 °C) from 25°C ambient.

Operating Temperature: -40°C ~ +125°C (including self-temperature rise)

Storage Condition: -40°C ~ +125°C (on board), -10°C ~ +40°C (with packaging) and R.H. 60 max.

AOTA-B201208S Series is **RoHS Compliant and Pb free.**

Part Identification

AOTA-B201208S

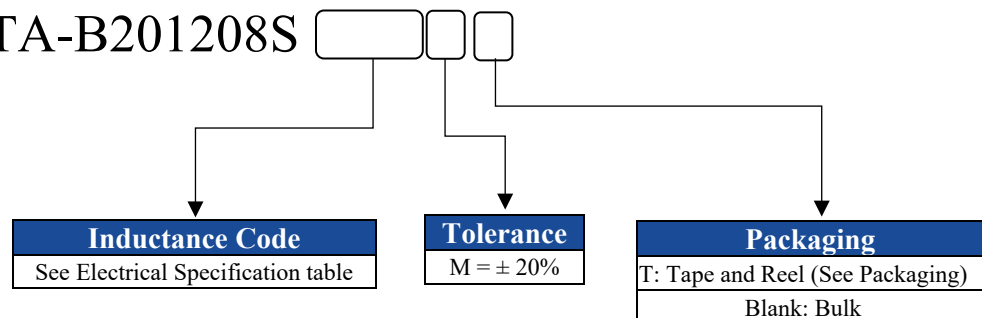

5101 Hidden Creek Ln, Spicewood TX 78669
 Phone: 512-371-6159 Fax: 512-351-8858
 For terms and conditions of sales, please visit:
www.abracon.com

REVISION Initial Release :
11/10/2023

ABRACON IS
 ISO9001-2015
 CERTIFIED

MINI MOLDED POWER INDUCTOR

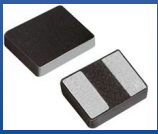

AOTA-B201208S

Request Samples



Check Inventory



2.0 x 1.2 x 0.8 mm
RoHS/RoHS II Compliant
 MSL Level = 1

Performance Graphs

Saturation Current

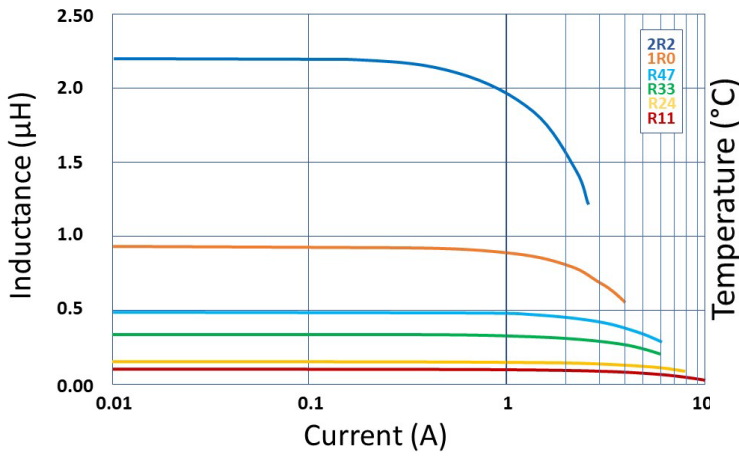

Temperature Rise Current

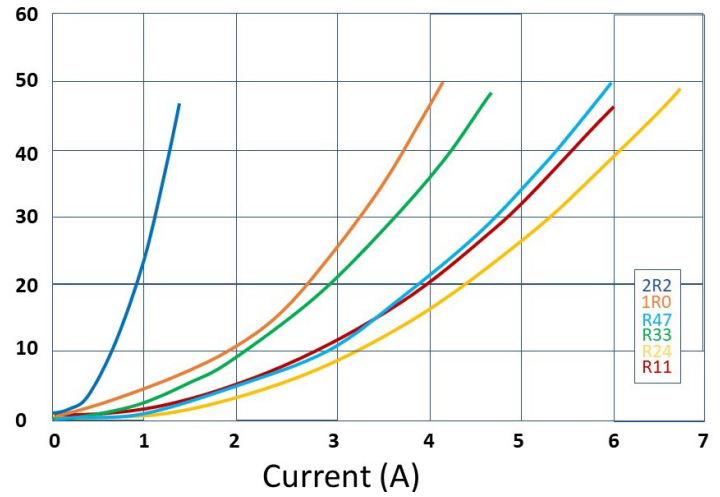

Inductance vs. Frequency

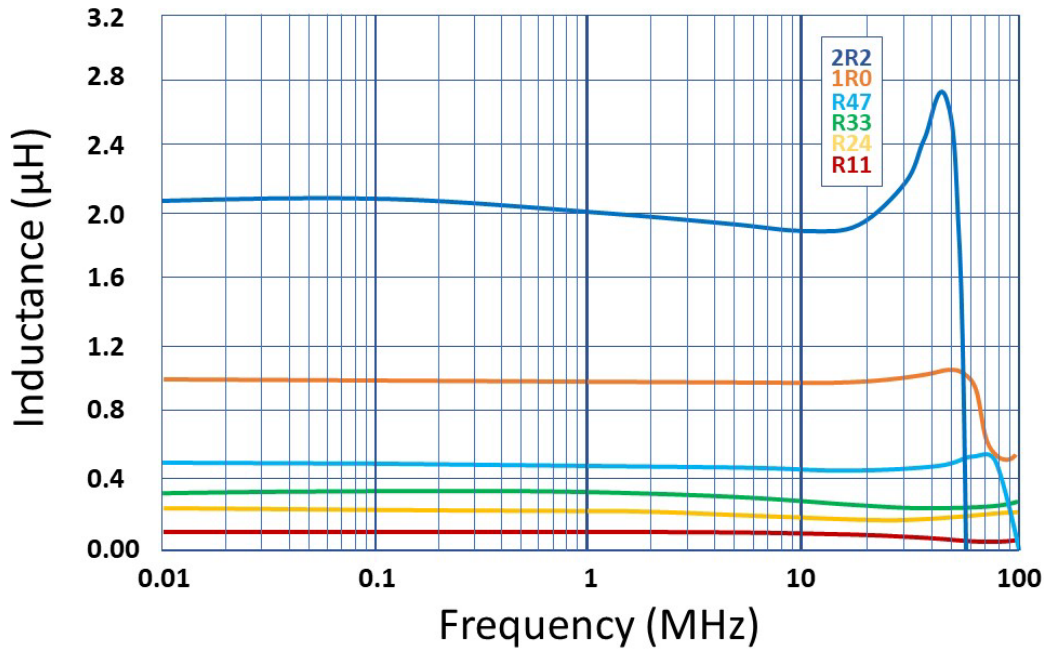

MINI MOLDED POWER INDUCTOR

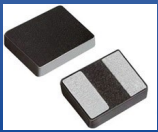

AOTA-B201208S

Request Samples



Check Inventory



2.0 x 1.2 x 0.8 mm
RoHS/RoHS II Compliant
MSL Level = 1

Mechanical Specifications

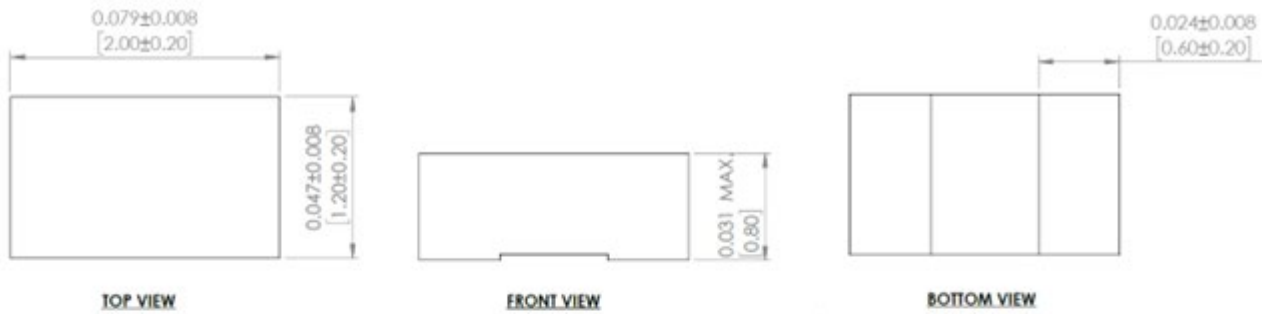

Recommended Land Pattern

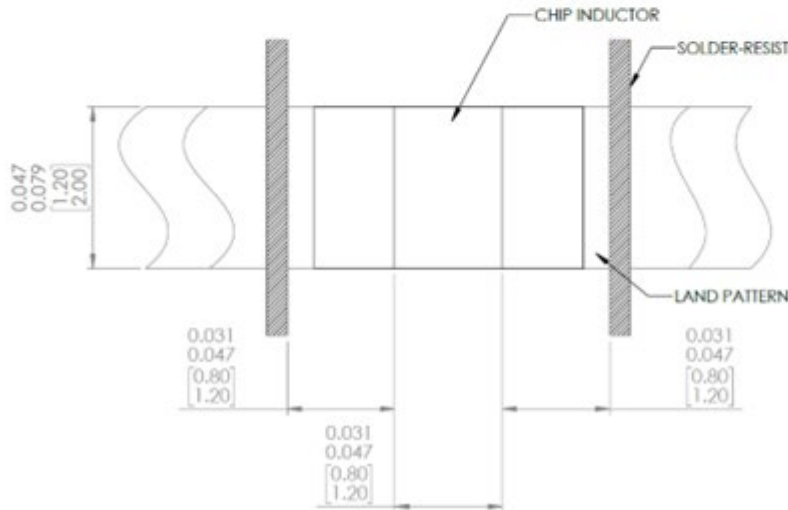

Dimensions: Inch[mm]

Marking

No Marking

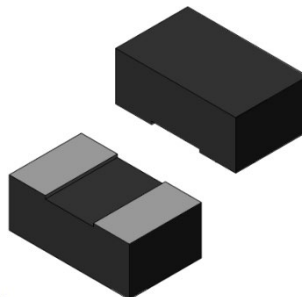

MINI MOLDED POWER INDUCTOR

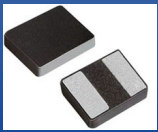

AOTA-B201208S

Request Samples



Check Inventory



2.0 x 1.2 x 0.8 mm
RoHS/RoHS II Compliant
MSL Level = 1

Reflow Profile

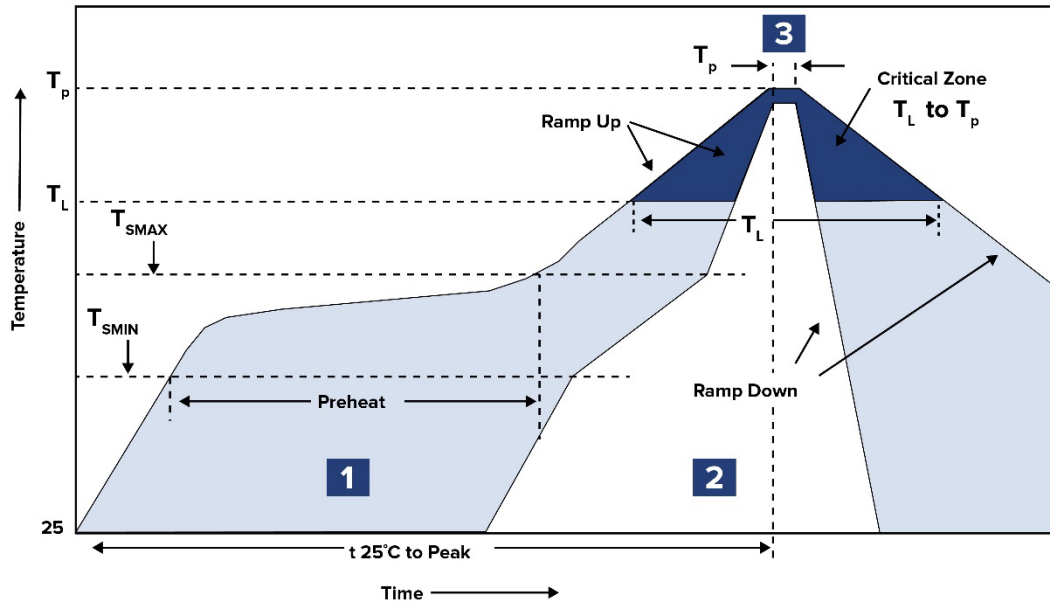

Zone	Description	Temperature	Times
1	Preheat	$T_{SMIN} \sim T_{SMAX}$ 150°C ~ 200°C	60 ~ 120 sec.
2	Reflow	T_L $\geq 217^\circ\text{C}$	60 ~ 90 sec.
3	Peak heat	T_P 260°C Max	10 sec. MAX

MINI MOLDED POWER INDUCTOR

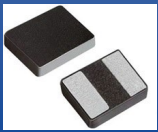

AOTA-B201208S

Request Samples



Check Inventory



2.0 x 1.2 x 0.8 mm
RoHS/RoHS II Compliant
MSL Level = 1

Packaging

Tape & Reel: 3000 pcs/reel

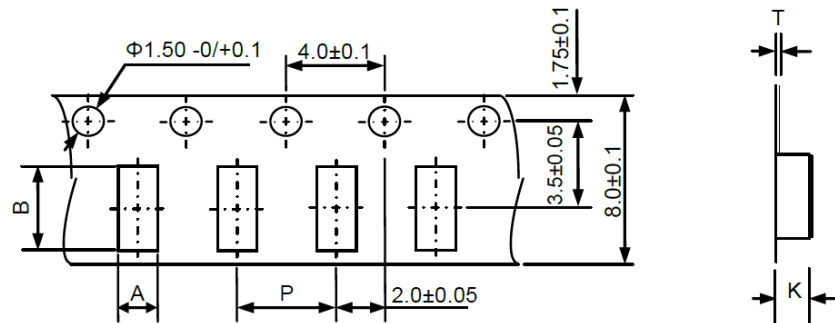

A	B	P	K	T
1.50±0.1	2.30±0.1	4.0±0.1	1.10 Max	0.3 Max

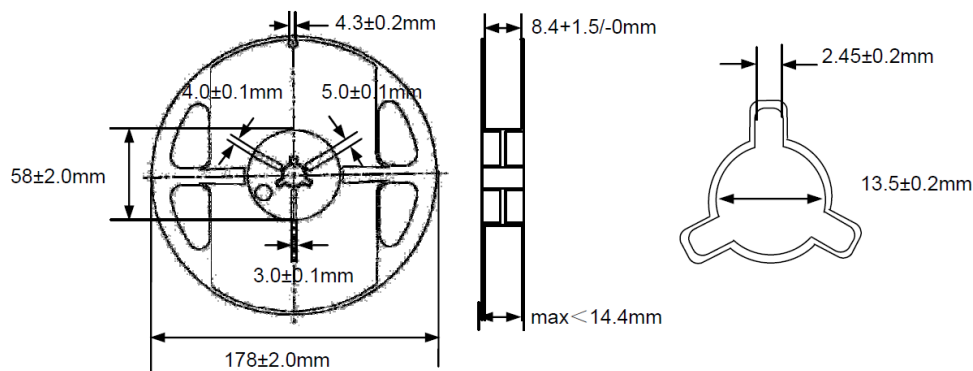

Dimensions: mm

ATTENTION: Abracon LLC's products are COTS – Commercial-Off-The-Shelf products; suitable for Commercial, Industrial and, where designated, Automotive Applications. Abracon's products are not specifically designed for Military, Aviation, Aerospace, Life-dependent Medical applications or any application requiring high reliability where component failure could result in loss of life and/or property. For applications requiring high reliability and/or presenting an extreme operating environment, written consent and authorization from Abracon LLC is required. Please contact Abracon LLC for more information.



5101 Hidden Creek Ln, Spicewood TX 78669
 Phone: 512-371-6159 Fax: 512-351-8858
 For terms and conditions of sales, please visit:
www.abracon.com

REVISION Initial Release :
11/10/2023

ABRACON IS
 ISO9001-2015
 CERTIFIED

X-ON Electronics

Largest Supplier of Electrical and Electronic Components

Click to view similar products for [Power Inductors - SMD category](#):

Click to view products by [Abracon manufacturer](#):

Other Similar products are found below :

[SPD62R-472M](#) [LLQPB201214T1R0M](#) [LLXND3030QKT470MNG](#) [LLQPB160807T4R7M](#) [LLAPB2016KKTR33M](#)
[LBXND4040TKL330MDG](#) [LLXNE3030KKT4R7MN](#) [LSQEA201212T100M](#) [IHLP5050CEER4R7M06](#) [LVS505020-1R0T-N](#) [LVS505040-1R2T-N](#) [LVS606020-1R5M-N](#) [LVS606028-6R8M-N](#) [LVS606045-102M-N](#) [LVS606045-150M-N](#) [LVS606045-1R8M-N](#) [LVS606045-6R8M-N](#) [LVS808040-2R0M-N](#) [LVS808040-330M-N](#) [LVS808040-4R7M-N](#) [MHCI06030-R56M-R8](#) [SCD0403T-470M-N](#) [SCD0403T-6R8K-N](#) [SCD0504T-101M-N](#) [SCD0504T-120M-N](#) [SCD0504T-221M-N](#) [SCD0504T-470M-N](#) [SCD0504T-471M-N](#) [SCD0705T-180M-N](#) [SCD0705T-221M-N](#) [SCD0705T-470M-N](#) [SCD1005T-101M-N](#) [SCD1005T-221M-N](#) [SCD1005T-470M-N](#) [SSL1306T-101M-N](#) [LQB15NNR27K10D](#) [201610CDMCDDS-R47MC](#) [201610CDMCDDS-1R0MC](#) [201610CDMCDDS-R68MC](#) [LSQPB201210T220M](#) [LBCNF2012KKTR24MA](#) [LSQEA201212T220K](#) [LSENC2016KKT1R0M](#) [LSQNB160808T470M](#) [LSBHB1608KKT2R2MG](#) [LSQPB160807T2R2M](#) [LSQEA201212T101K](#) [LCXND4040MKL4R7MDG](#) [DEM8045Z-5R6N=P3](#) [LCXND3030QKT4R7MNG](#)