

RFID Patch Antenna

APAES923R3640C16-T

RoHS/RoHS II compliant



36.0 x 36.0 x 4.0mm

MSL level: Not Applicable

FEATURES:

- High Gain
- Pin type
- Customization Available
- RoHS Compliance

TYPICAL APPLICATIONS:

RFID systems for Logistic & Inventory Management of Retail, Pharmaceutical, Automotive Industries; Industrial automation, Contactless smart cards.

STANDARD SPECIFICATIONS:

Parameters	Min.	Typ.	Max.	Units	Note
Receiving Frequency Range	918		927	MHz	
Center Frequency ^(*)	923			MHz	(On 40*40mm GND Plane)
Bandwidth	5			MHz	(Return loss \leq 10dB)
Gain		1.5		dBic	(Peak gain on (On 70*70mm GND Plane facing Zenith.))
Axial Ratio			2.5	dB	
VSWR @ Center Frequency			1.5		
Polarization Model	RHCP				(Right Hand Circular Polarization)
Impedance	50			Ω	
Frequency Temperature Coefficient	-10		10	ppm/ $^{\circ}$ C	

^(*) Application environment, including size of the ground plane, proximity to adjacent components, etc., will affect stated performance. Fine tuning might be required when installed on end-customer's PCB. Abracon offers Antenna Optimization Service, please contact Abracon.

TEST CONDITIONS & TEST SETUP:

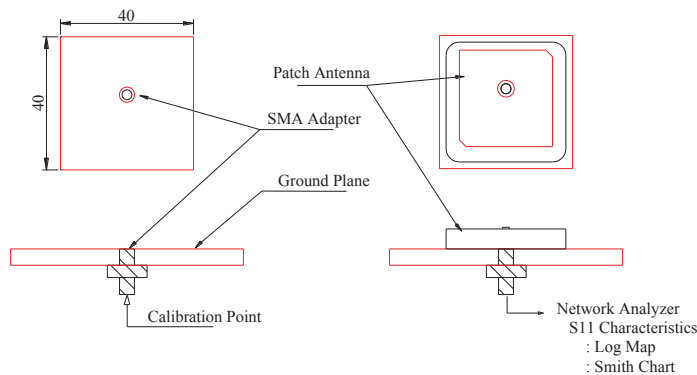

STRUCTURE AND MATERIAL

Description	Material
Antenna Substrate	Dielectric Ceramics
Pin	Copper and tinplated
Electrode	Ag Plated
Ground Plane	Ag Plated
Adhesive Type	NITTO 5000NS

RFID Patch Antenna

APAES923R3640C16-T

RoHS/RoHS II compliant



36.0 x 36.0 x 4.0mm

SMITH CHART

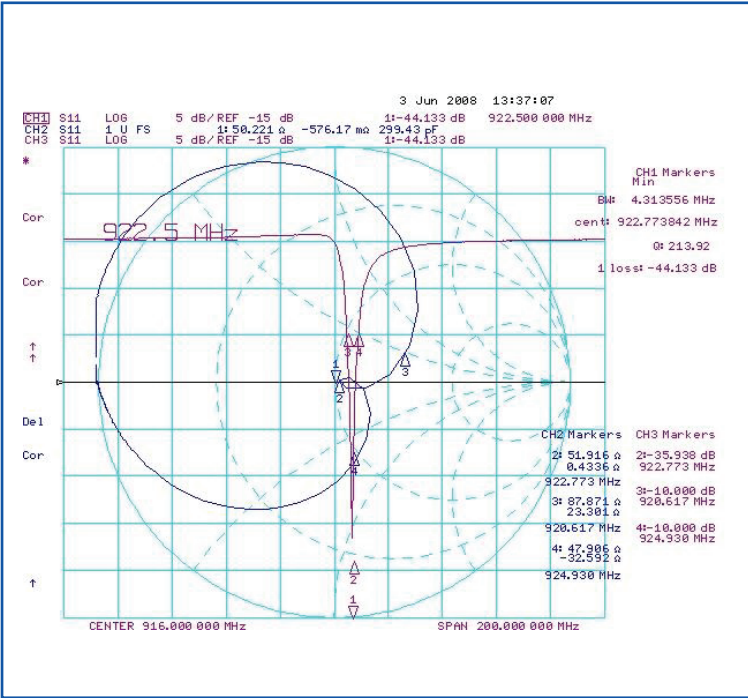

RADIATION PATTERN

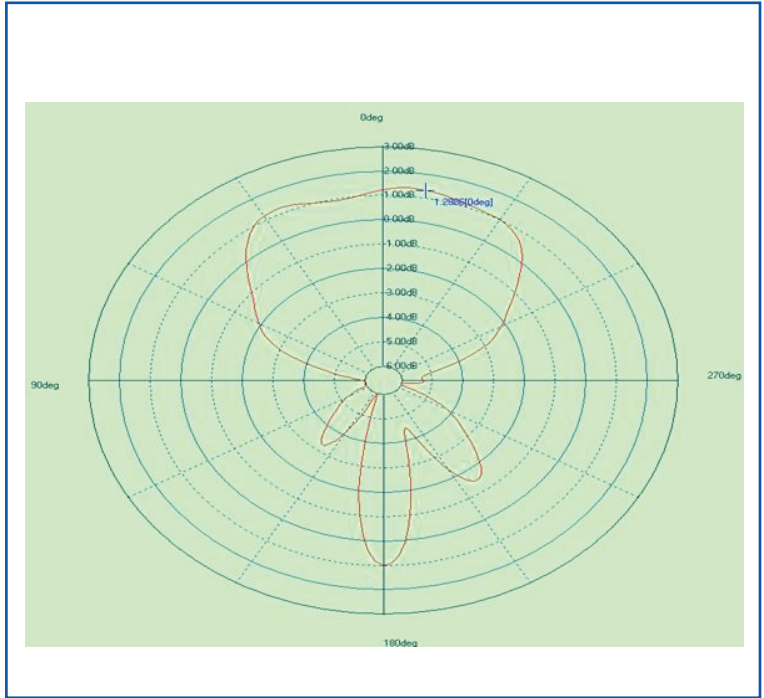

OUTLINE DIMENSION:

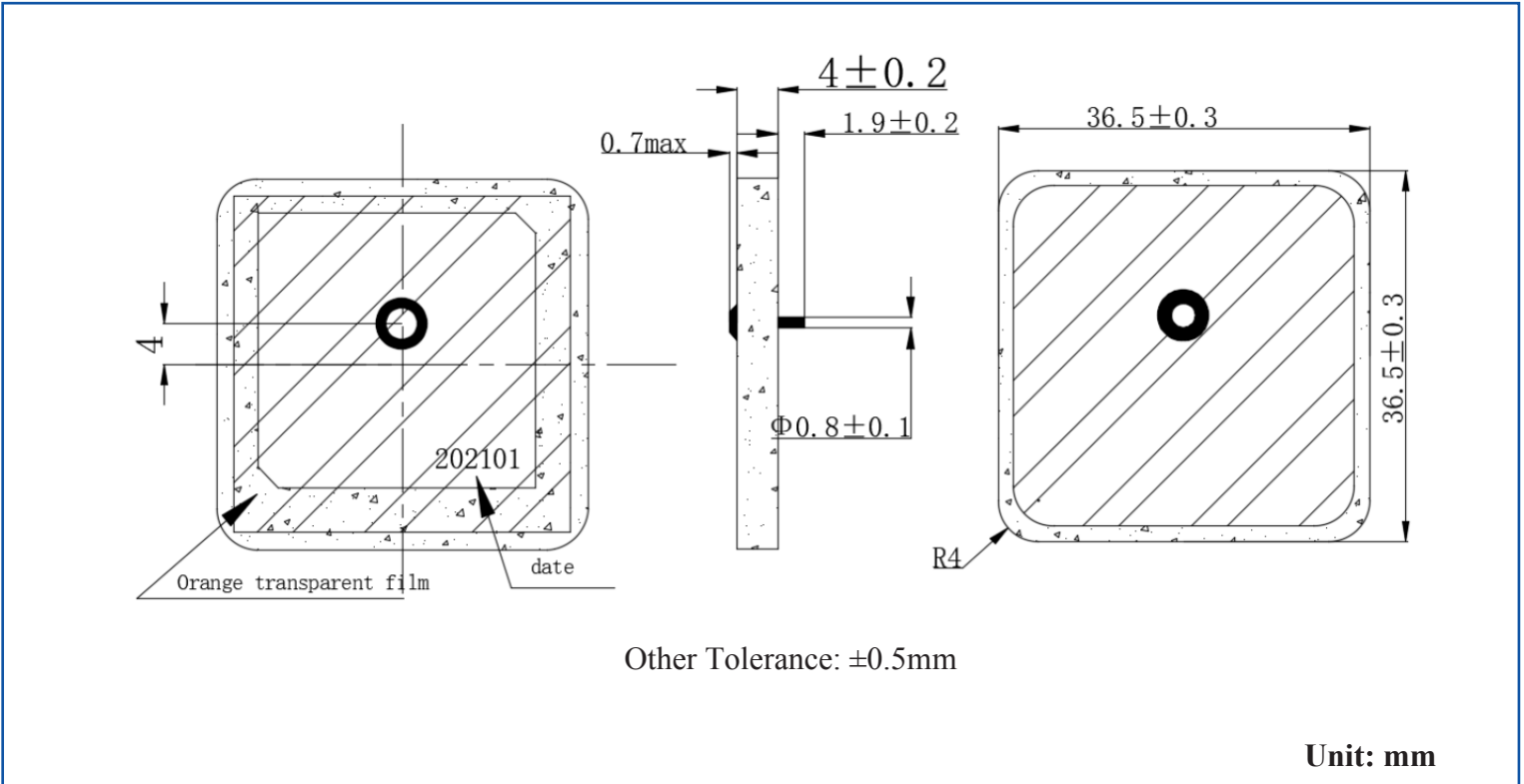

RFID Patch Antenna

APAES923R3640C16-T

RoHS/RoHS II compliant



36.0 x 36.0 x 4.0mm

PACKAGING:

Package Type	Quantity
Tray	25 pcs/tray
Inner Box	250 pcs/box
Outer Box	500 pcs/box

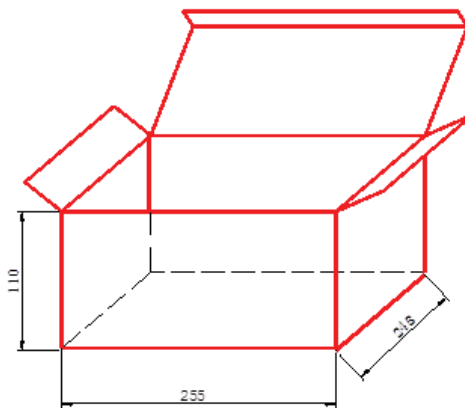
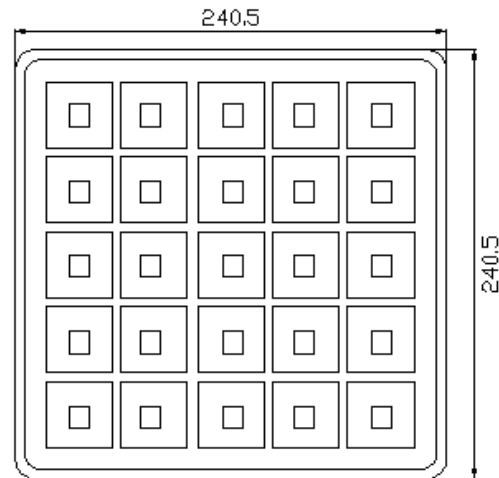

Inner Box

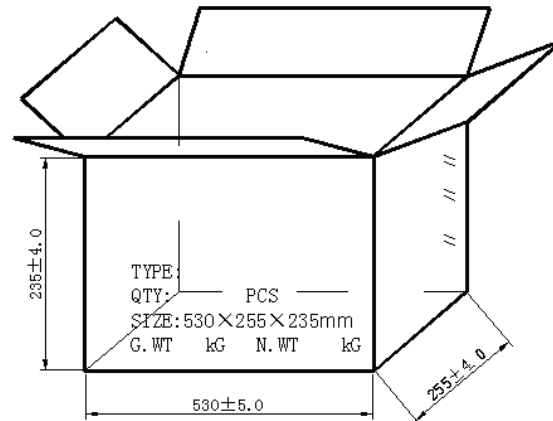

Outer Box

CAUTION:

- (1) Do not apply excess mechanical stress to the component body or terminations. Do not attempt to re-form or bend the components as this will cause damage to the component.
- (2) Do not expose the component to open flame.
- (3) This specification applies to the functionality of the component as a single unit. Please insure the component is thoroughly evaluated in the application circuit.

NOTE:

- 1) The parts are manufactured in accordance with this specification. If other conditions and specifications which are required for this specification, please contact ABRACON for more information.
- 2) ABRACON will supply the parts in accordance with this specification unless we receive a written request to modify prior to an order placement.
- 3) In no case shall ABRACON be liable for any product failure from in appropriate handling or operation of the item beyond the scope of this specification.
- 4) When changing your production process, please notify ABRACON immediately.
- 5) ABRACON Corporation's products are COTS – Commercial-Off-The-Shelf products; suitable for Commercial, Industrial and, where designated, Automotive Applications. ABRACON's products are not specifically designed for Military, Aviation, Aerospace, Life-dependant Medical applications or any application requiring high reliability where component failure could result in loss of life and/or property. For applications requiring high reliability and/or presenting an extreme operating environment, written consent and authorization from ABRACON Corporation is required. Please contact ABRACON Corporation for more information.
- 6) All specifications and Marking will be subject to change without notice.

ATTENTION: Abracon LLC's products are COTS – Commercial-Off-The-Shelf products; suitable for Commercial, Industrial and, where designated, Automotive Applications. Abracon's products are not specifically designed for Military, Aviation, Aerospace, Life-dependent Medical applications or any application requiring high reliability where component failure could result in loss of life and/or property. For applications requiring high reliability and/or presenting an extreme operating environment, written consent and authorization from Abracon LLC is required. Please contact Abracon LLC for more information.

ABRACON IS
ISO9001-2015
CERTIFIED



REVISED: 07/19/2021

Headquarters:

5101 Hidden Creek Ln Spicewood TX 78669 Phone: 512-371-6159

| Fax: 512-351-8858

X-ON Electronics

Largest Supplier of Electrical and Electronic Components

Click to view similar products for [Antennas](#) category:

Click to view products by [ABRACON](#) manufacturer:

Other Similar products are found below :

[GAN30084EU](#) [930-033-R](#) [GW17.07.0250E](#) [1513563-1](#) [EXE902SM](#) [APAMPG-117](#) [MAF94383](#) [W3908B0100](#) [W6102B0100](#) [YE572113-](#)
[30RSMM](#) [108-00014-50](#) [66089-2406](#) [A09-F8NF-M](#) [A09-F5NF-M](#) [RGFRA1903041A1T](#) [W3593B0100](#) [W3921B0100](#) [SIMNA-868](#) [SIMNA-](#)
[915](#) [SIMNA-433](#) [W1044](#) [W1049B090](#) [A75-001](#) [WTL2449CQ1-FRSMM](#) [CPL9C](#) [EXB148BN](#) [0600-00060](#) [TRA9020S3PBN-001](#) [GD5W-](#)
[28P-NF](#) [MA9-7N](#) [GD53-25](#) [GD5W-21P-NF](#) [EXB144SM](#) [C37](#) [MAF94051](#) [GD35-17P-NF](#) [P1744](#) [MA9-5N](#) [EXD420PL](#) [B1322NR](#)
[QWFTB120](#) [MAF94271](#) [MAF94300](#) [GPSMB301](#) [FG4403](#) [AO-AGSM-OM54](#) [5200232](#) [MIKROE-2349](#) [WCM.01.0111](#) [MIKROE-2393](#)