

1-PORT 10GBASE-T SMD RJ45 WITH INTEGRATED MAGNETICS

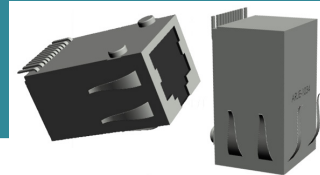

ARJE-1034

16.10 x 13.87 x 25.68mm
RoHS/RoHS II Compliant

FEATURES

- High speed 10GBase-T
- 10/100/1000Base-T compatibility
- Surface mount device
- Wide -40C to 85C operating temperature range
- Integrated magnetics
- Integrated shielding and metal fingers for excellent EMI performance

APPLICATIONS

- Networking equipment
- Industrial IoT/IoT
- Video IP cameras
- Machine-to-machine (M2M)
- Industrial process control
- Servers and cloud computing
- High performance computing (HPC)
- Network interface cards (NIC)
- Media converters

STANDARD SPECIFICATIONS

Parameters	Minimum	Typical	Maximum	Units	Notes
Turn Ratio ($\pm 3\%$)		1CT:1CT			
Inductance	100			μH	100kHz, 0.1Vrms
Insertion Loss			-3.0	dB	100KHz
			-2.0		1-400MHz
Return Loss	-18.0			dB	1-40MHz
	$19-10\text{Log}(F/40)^*$				40-500MHz
Crosstalk	-30.0			dB	1-100MHz
	-20.0				100-500MHz
CM-DMRR	-30.0			dB	1-250MHz
	-20.0				250-500MHz
Hipot		1500 Vrms min		Pri to Sec	
Operating Temperature	-40		85	C	See options

PART NUMBER IDENTIFICATION

ARJE-1034-

Operating Temperature (See Table 1 for details)

Blank: -40°C ~ +85°C
A: 0°C ~ +70°C

1-PORT 10GBASE-T SMD RJ45 WITH INTEGRATED MAGNETICS

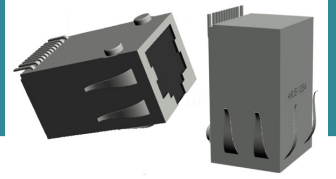

16.10 x 13.87 x 25.68mm
RoHS/RoHS II Compliant

ARJE-1034

MECHANICAL DIMENSIONS: mm (unless otherwise specific, all tolerances are ±0.01/0.25)

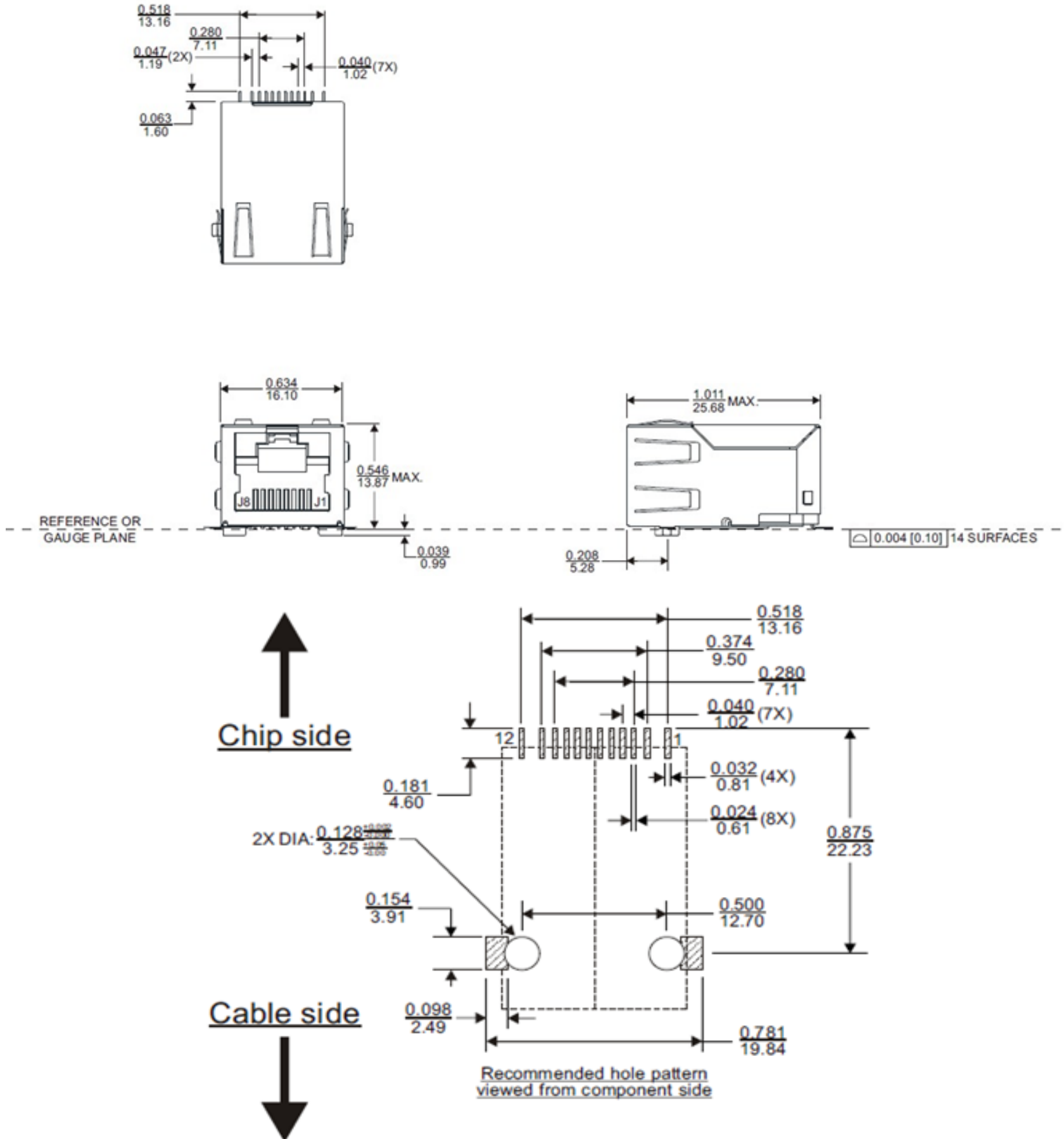

REVISED: 09/26/2016

1-PORT 10GBASE-T SMD RJ45 WITH INTEGRATED MAGNETICS

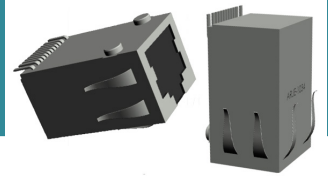

ARJE-1034

16.10 x 13.87 x 25.68mm
RoHS/RoHS II Compliant

SCHEMATIC

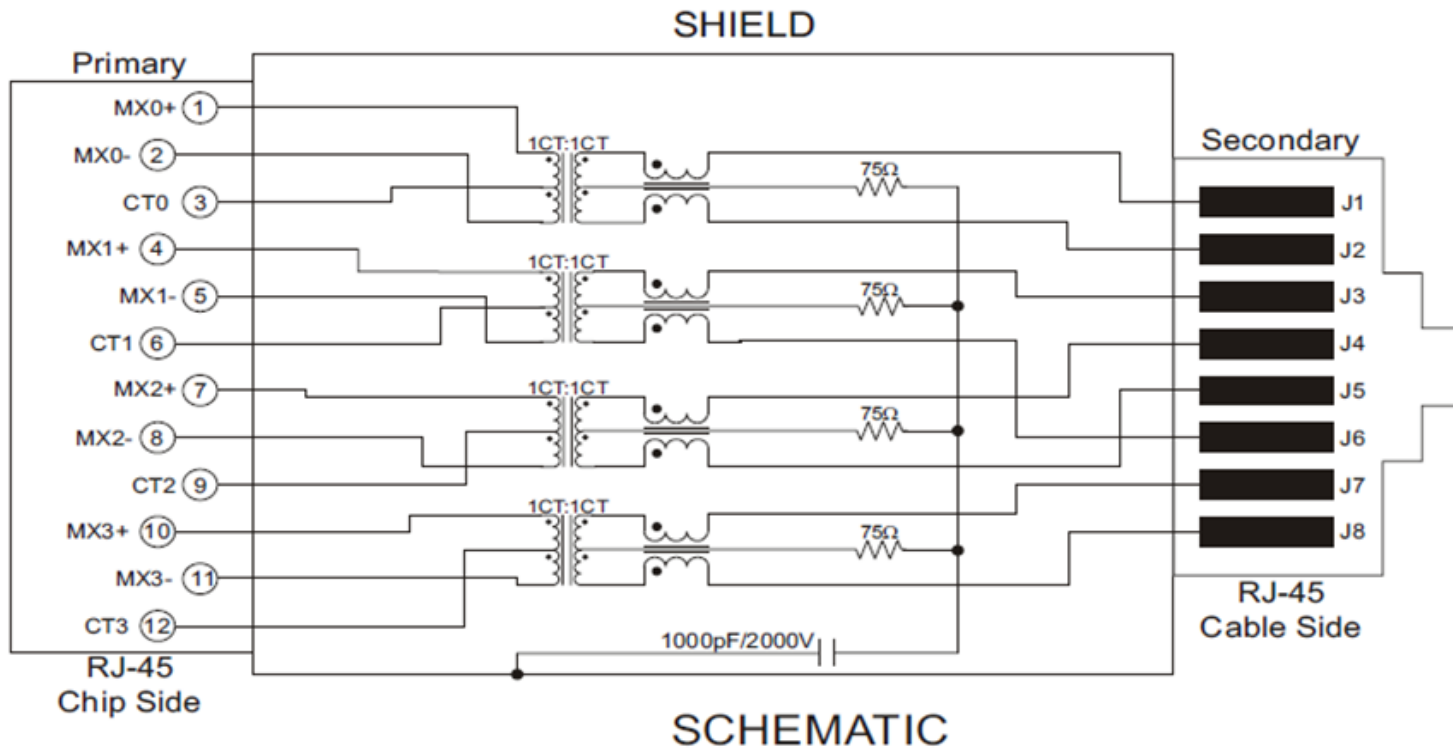

REFLOW

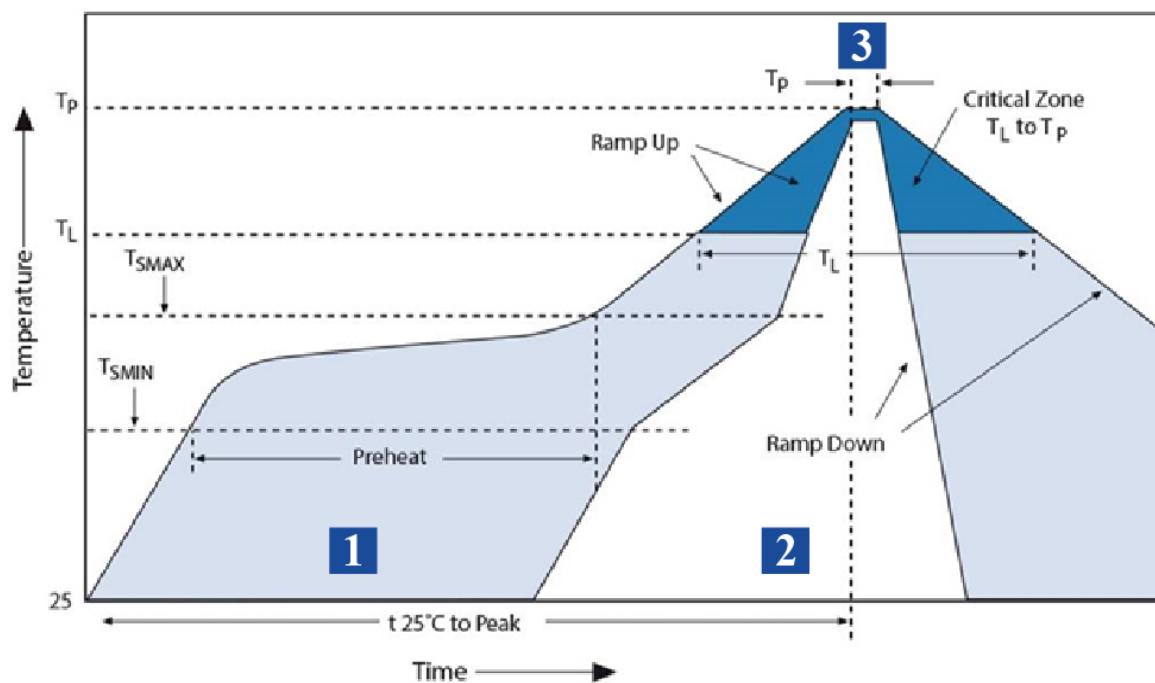

Zone	Description	Temperature	Time
1	Preheat	$T_{SMIN} \sim T_{SMAX}$ 150°C ~ 200°C	60 ~ 180 sec.
2	Reflow	T_L 217°C	60 ~ 150 sec.
3	Peak heat	T_p 245°C	20 ~ 40 sec.

REVISED: 09/26/2016

1-PORT 10GBASE-T SMD RJ45 WITH INTEGRATED MAGNETICS

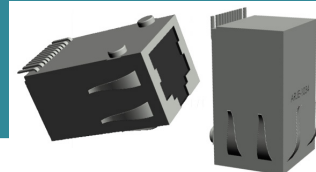

ARJE-1034

16.10 x 13.87 x 25.68mm
RoHS/RoHS II Compliant

PACKAGING

T: 110 pcs/reel

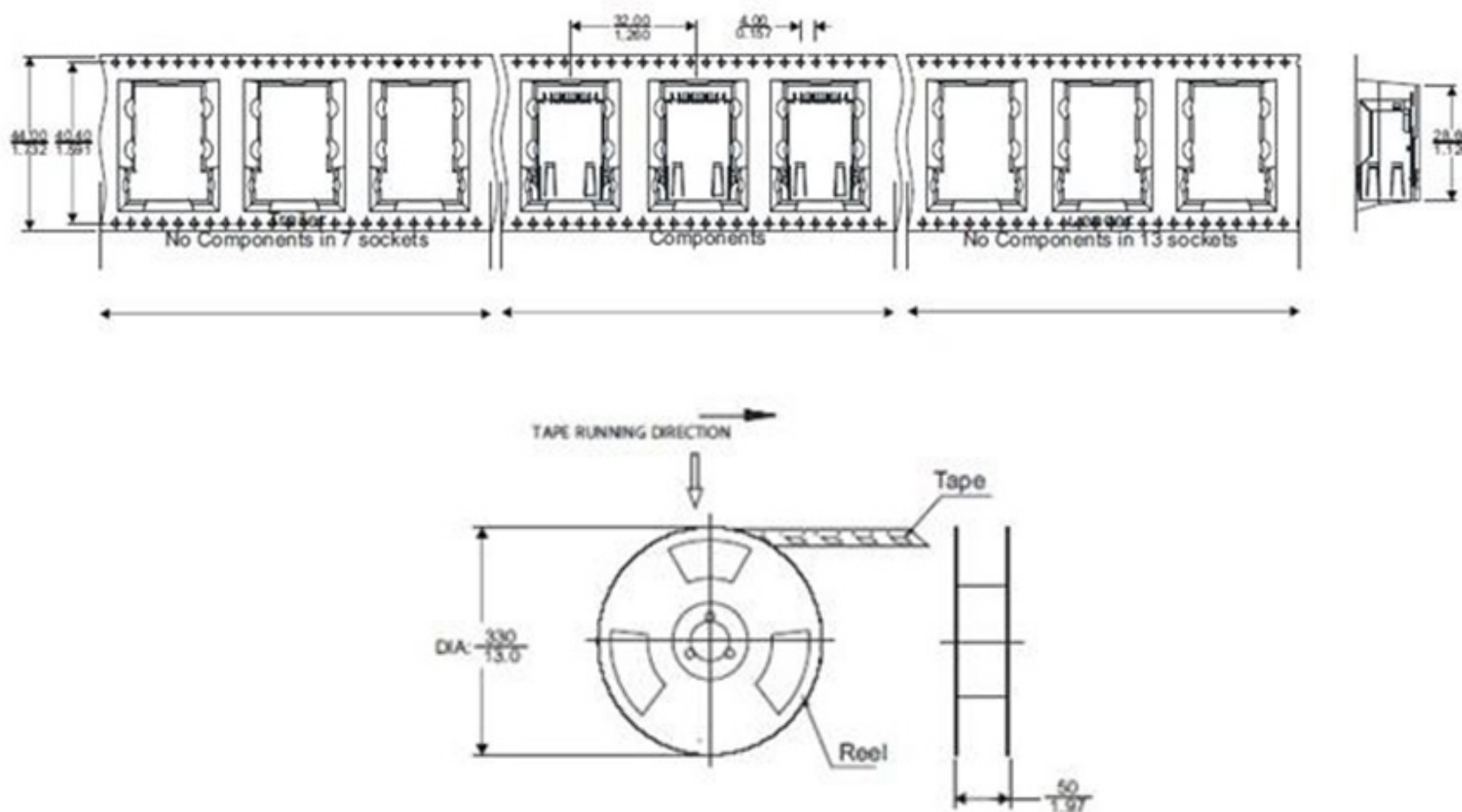

NOTES

1. The parts are manufactured in accordance with this specification. If other conditions and specifications which are required for this specification, please contact ABRACON for more information.
2. ABRACON will supply the parts in accordance with this specification unless we receive a written request to modify prior to an order placement.
3. In no case shall ABRACON be liable for any product failure from in appropriate handling or operation of the item beyond the scope of this specification.
4. When changing your production process, please notify ABRACON immediately.
5. ABRACON LLC's products are COTS – Commercial-Off-The-Shelf products; suitable for Commercial, Industrial and, where designated, Automotive Applications. ABRACON's products are not specifically designed for Military, Aviation, Aerospace, Life- dependent Medical applications or any application requiring high reliability where component failure could result in loss of life and/or property. For applications requiring high reliability and/or presenting an extreme operating environment, written consent and authorization from ABRACON LLC is required. Please contact ABRACON LLC for more information.
6. All specifications and Marking will be subject to change without notice.

X-ON Electronics

Largest Supplier of Electrical and Electronic Components

Click to view similar products for [Modular Connectors / Ethernet Connectors](#) category:

Click to view products by [Abracon](#) manufacturer:

Other Similar products are found below :

[8949-H88/06BLKA/SN](#) [74441-0010/BKN](#) [MP1010RX-1000](#) [MP44RX-1000](#) [PHP-6P6C-5](#) [GAX-3-66](#) [GAX-8-62](#) [GDCX-PA-66-50](#) [GDCX-PN-64](#) [GDCX-PN-66](#) [GDCX-PN-66-50](#) [GDLX-A-66](#) [GDLX-N-66](#) [GDLX-S-66](#) [GDLX-S-88K](#) [GDTX-S-88-50](#) [GDX-PA-1010](#) [GLX-N-1010M-BLK](#) [GLX-S-88M-BLK](#) [GMX-N-1010](#) [GMX-S-1010](#) [GMX-S-66](#) [GMX-SMT4-N-88](#) [GPX-2-64](#) [GSGX-N-2-88](#) [GSGX-N-4-88](#) [GSX-NS2-88-3.05](#) [GSX-NS2-88-3.05-50](#) [GSX-NS-88-3.05-50](#) [PT-108A-8C-UL](#) [PT-J951-8C](#) [PTS-J531-8CS-50UL](#) [1-1775629-2](#) [A-2014-0-4](#) [GWLX-S-88-GR](#) [GWLX-S9-88-YG](#) [DC-1021-8-WH-6](#) [1300530003](#) [1324640-4](#) [RJ11FTVC2G](#) [RJ11FTVC2N](#) [RJFTVX2SA1G](#) [132764-001](#) [1413235](#) [MP88X-1000](#) [MPS88RX-5000](#) [MRJR-5481-0F2](#) [E5288-S000K3-L](#) [E5908-15A242-L](#) [155302-001](#)