

# Automotive & Industrial Grade 32.768kHz Continuous Voltage SMD Crystal X

ASEKDVAIG

Request Samples



Check Inventory



ESD Sensitive



3.2 x 2.5 x 1.2 mm  
RoHS/RoHS II Compliant  
MSL Level = N/A

## Features

- Continuous V<sub>DD</sub> operation from 1.62 V ~ 3.63 V
- Optimized for low current consumption
- Output Enable/Start & Disable/Stop function
- Output waveform CMOS/LVCMOS compatible
- Hermetically seam-sealed ceramic package
- AEC-Q200 Qualified
- Automotive Grade 1: -40°C to +125°C
- TS16949 Production Line Certified
- PPAP Available Upon Request

## Applications

- Infotainment Systems
- Keyless Entry & Startup
- GPS & Navigation
- Comfort control
- ADAS (Advanced Driver Assistance Systems)
- Vehicle to Vehicle Communication
- LiDAR (Light Detection and Ranging)
- In-vehicle Networking
- Powertrain & Drive Control
- Power Control & Conversion
- Industrial Control & Automation

## Electrical Specifications

Parameters	Min.	Typ.	Max.	Units	Notes
Frequency		32.768		kHz	
Operating Temperature Range	-40.0		+125	°C	See options
Storage Temperature Range	-55.0		+125	°C	
Overall Frequency Stability <sup>[Note 1]</sup>	-100		+100	ppm	See options
Supply Voltage (V <sub>dd</sub> )	+1.62		+3.63	V	
Tri-state function <sup>[Note 2]</sup>	“1” (VIH≥0.7*V <sub>dd</sub> ) or Open: Oscillation; “0” (VIL<0.3*V <sub>dd</sub> ): No Oscillation/Hi Z			V	
Output Load			15	pF	CMOS
Output Voltage	V <sub>OH</sub>	0.9*V <sub>dd</sub>		V	
	V <sub>OL</sub>		0.1*V <sub>dd</sub>		
Aging 1 year @25°C± 3°C	-3.0		+3.0	ppm	
Aging 5 years @25°C± 3°C	-5.0		+5.0	ppm	
Symmetry @ ½ V <sub>dd</sub>	45	50	55	%	
Start-up Time			30	ms	
Rise and Fall Time (Tr/Tf) @10%V <sub>dd</sub> -90%V <sub>dd</sub> , 15pF load			30	ns	
Disable Current			5	µA	
Supply Current (I <sub>dd</sub> ) @25°C± 3°C	V <sub>dd</sub> = 3.3V	10	15	µA	No Load
	V <sub>dd</sub> = 2.5V	9	14	µA	No Load
	V <sub>dd</sub> = 1.8V	8	13	µA	No Load

**Note 1:** Overall frequency stability includes initial frequency tolerance @25°C± 3°C and stability over the operating temperature range.

**Note 2:** Do not leave pin 1 (INH) floating. If pin 1 (INH) is not utilized for toggling, it must be tied to V<sub>dd</sub> (logic 1).

## Part Identification

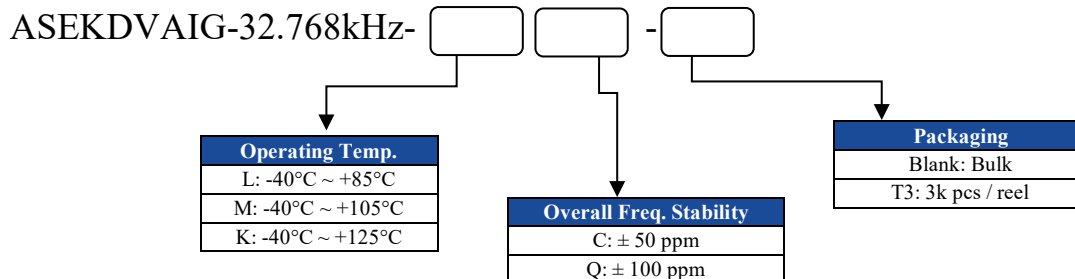

5101 Hidden Creek Ln Spicewood TX 78669  
Phone: 512-371-6159 | Fax: 512-351-8858  
For terms and conditions of sales, please visit:  
www.abracon.com

REVISED: 06-30-22

ABRACON IS  
ISO9001-2015  
CERTIFIED

# Automotive & Industrial Grade 32.768kHz Continuous Voltage SMD Crystal X

ASEKDVAIG

Request Samples



Check Inventory



ESD Sensitive



3.2 x 2.5 x 1.2 mm  
RoHS/RoHS II Compliant  
MSL Level = N/A

## Typical Current Consumption (I<sub>dd</sub>) vs. Supply Voltage (V<sub>dd</sub>) Characteristics [ @ 25°C ± 3°C, No Load ]

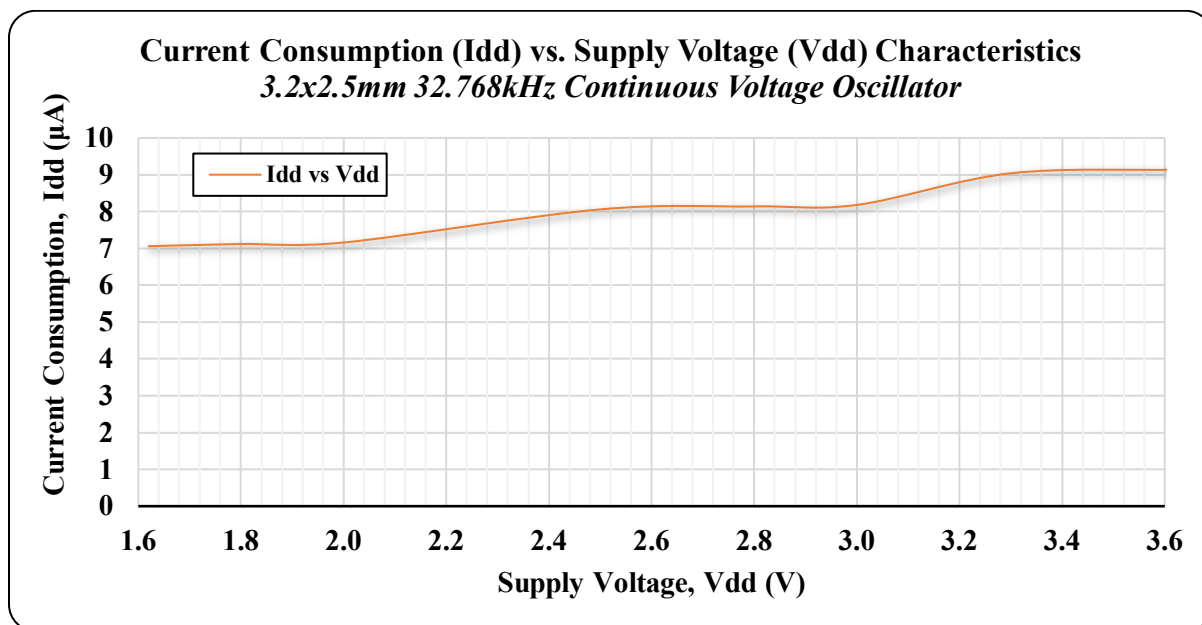

## Typical Frequency vs. Supply Voltage (V<sub>dd</sub>) Characteristics [ @ 25°C ± 3°C, Normalized to V<sub>dd</sub>=3.3Vdc ]

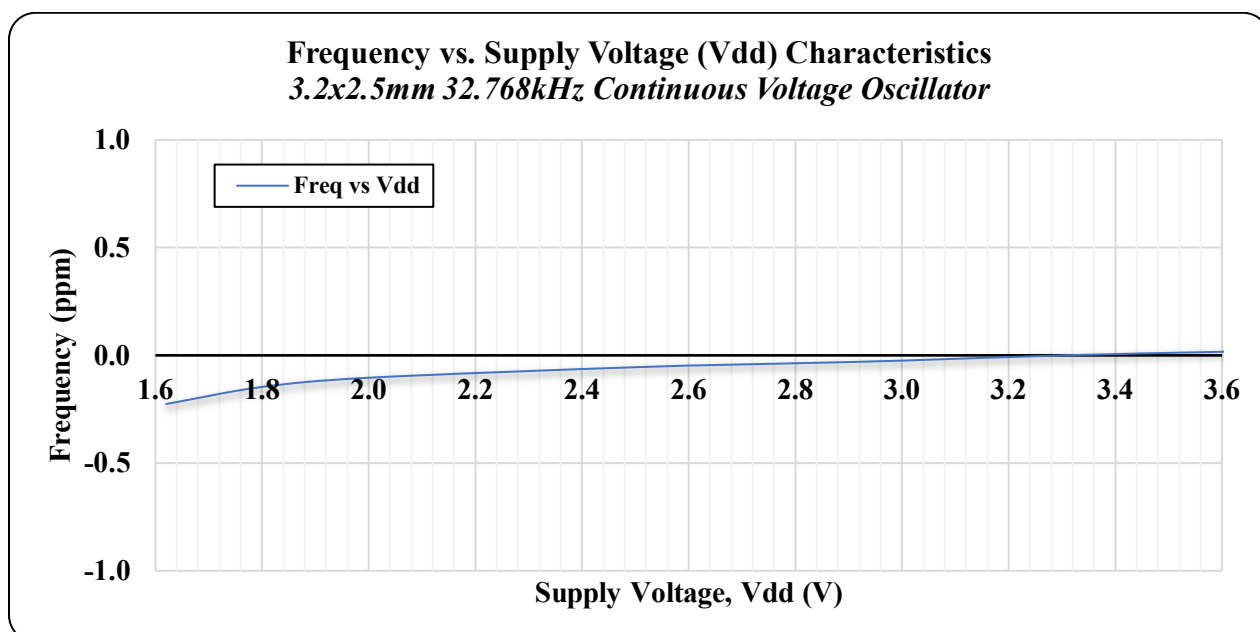

# Automotive & Industrial Grade 32.768kHz Continuous Voltage SMD Crystal X

ASEKDVAIG

Request Samples



Check Inventory



ESD Sensitive



3.2 x 2.5 x 1.2 mm  
 RoHS/RoHS II Compliant  
 MSL Level = N/A

## Mechanical Dimensions

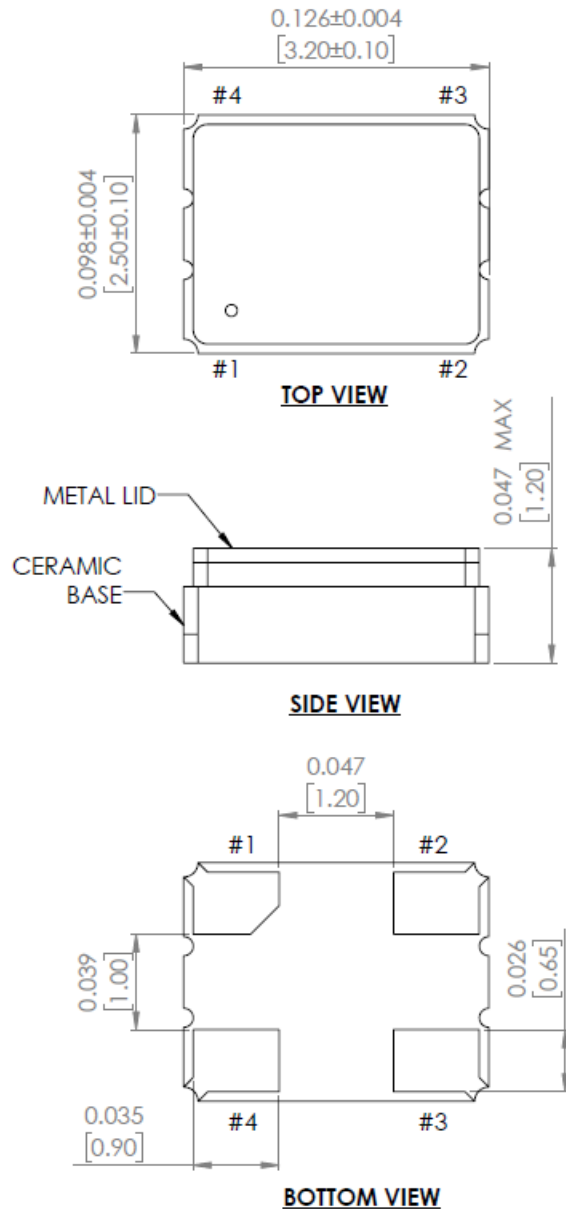

### Recommended Land Pattern

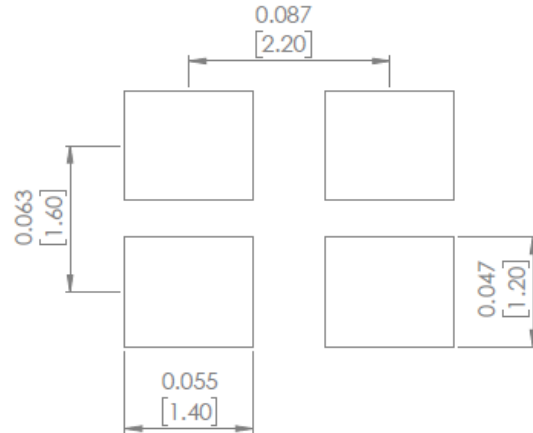

Pin #	Function
1	INH
2	GND
3	Output
4	Vdd

INH Function	
#1	#3 (Output)
Open	Active
"H" Level	Active
"L" Level	High Z (No Oscillation)

#### Note 3:

- Do not leave Pin 1 (INH) floating
- If Pin 1 (INH) is not utilized for toggling, it must be tied to Vdd (logic 1)

#### Note 4:

Recommended to use approximately 0.01µF bypass capacitor between PIN 2 and PIN 4

Dimensions: inches (mm)



5101 Hidden Creek Ln Spicewood TX 78669  
 Phone: 512-371-6159 | Fax: 512-351-8858  
 For terms and conditions of sales, please visit:  
[www.abracon.com](http://www.abracon.com)

REVISED: 06-30-22

ABRACON IS  
 ISO9001-2015  
 CERTIFIED

# Automotive & Industrial Grade 32.768kHz Continuous Voltage SMD Crystal X

ASEKDVAIG

Request Samples



Check Inventory



ESD Sensitive



3.2 x 2.5 x 1.2 mm  
RoHS/RoHS II Compliant  
MSL Level = N/A

## Reflow Profile [JDEC J-STD-020]

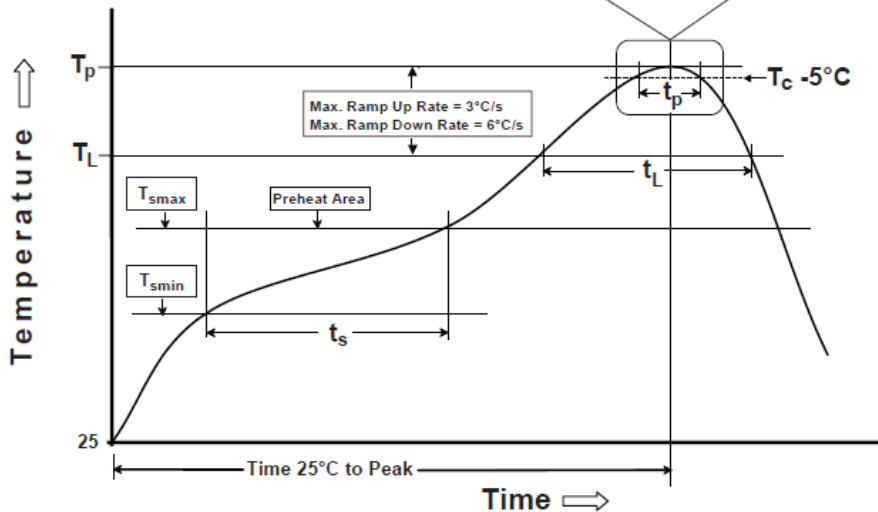
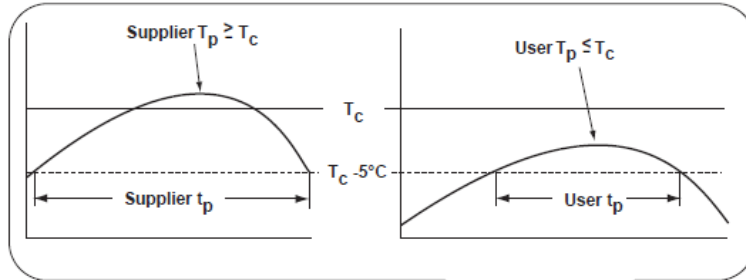

Table 1

### SnPb Eutectic Process Classification Temperatures (T<sub>c</sub>)

Package Thickness	Volume mm <sup>3</sup> <350	Volume mm <sup>3</sup> ≥350
<2.5 mm	235 °C	220 °C
≥2.5 mm	220 °C	220 °C

Table 2

### Pb-Free Process Classification Temperatures (T<sub>c</sub>)

Package Thickness	Volume mm <sup>3</sup> <350	Volume mm <sup>3</sup> 350-2000	Volume mm <sup>3</sup> >2000
<1.6 mm	260 °C	260 °C	260 °C
1.6 mm - 2.5 mm	260 °C	250 °C	245 °C
>2.5 mm	250 °C	245 °C	245 °C

Profile Feature	Sn-Pb Eutectic Assembly	Pb-Free Assembly
Preheat / soak		
Temperature minimum (T <sub>sm</sub> )	100°C	150°C
Temperature maximum (T <sub>sm</sub> )	150°C	200°C
Time (T <sub>sm</sub> to T <sub>sm</sub> ) (t <sub>s</sub> )	60 - 120 sec.	60 - 120 sec.
Average ramp-up rate (T <sub>sm</sub> to T <sub>p</sub> )	3°C/sec. max	3°C/sec. max
Liquidous temperature (T <sub>L</sub> )	183°C	217°C
Time at liquidous (t <sub>L</sub> )	60 - 150 sec.	60 - 150 sec.
Peak package body temperature (T <sub>p</sub> )*	see Table 1	see Table 2
Time (t <sub>p</sub> )** within 5°C of the specified classification temperature (T <sub>c</sub> )	20 sec.	30 sec.
Ramp-down rate (T <sub>p</sub> to T <sub>sm</sub> )	6°C/sec. max	6°C/sec. max
Time 25°C to peak temperature	6 min. max	8 min. max

\*Tolerance for peak profile temperature (T<sub>p</sub>) is defined as a supplier minimum and a user maximum.

\*\*Tolerance for time at peak profile temperature (t<sub>p</sub>) is defined as supplier minimum and a user maximum.



5101 Hidden Creek Ln Spicewood TX 78669  
Phone: 512-371-6159 | Fax: 512-351-8858  
For terms and conditions of sales, please visit:  
www.abracon.com

REVISED: 06-30-22

ABRACON IS  
ISO9001-2015  
CERTIFIED

# Automotive & Industrial Grade 32.768kHz Continuous Voltage SMD Crystal X

ASEKDVAIG

Request Samples



Check Inventory



ESD Sensitive



3.2 x 2.5 x 1.2 mm  
RoHS/RoHS II Compliant  
MSL Level = N/A

## Packaging

T3: 3,000pcs/reel

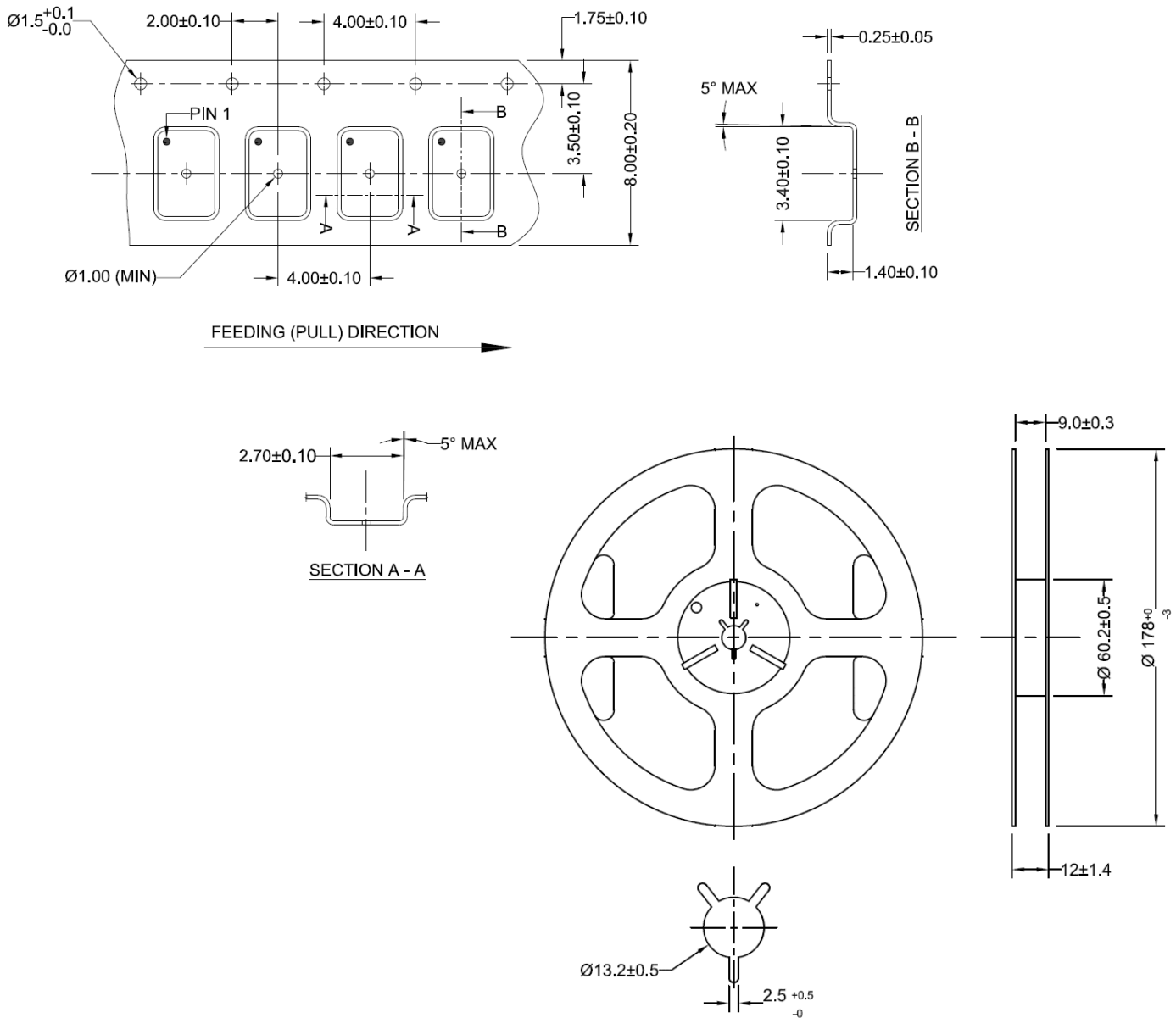

Dimensions: mm

**ATTENTION:** Abracon LLC's products are COTS – Commercial-Off-The-Shelf products; suitable for Commercial, Industrial and, where designated, Automotive Applications. Abracon's products are not specifically designed for Military, Aviation, Aerospace, Life-dependent Medical applications or any application requiring high reliability where component failure could result in loss of life and/or property. For applications requiring high reliability and/or presenting an extreme operating environment, written consent and authorization from Abracon LLC is required. Please contact Abracon LLC for more information.



5101 Hidden Creek Ln Spicewood TX 78669  
Phone: 512-371-6159 | Fax: 512-351-8858  
For terms and conditions of sales, please visit:  
[www.abracon.com](http://www.abracon.com)

REVISED: 06-30-22

ABRACON IS  
ISO9001-2015  
CERTIFIED

## X-ON Electronics

Largest Supplier of Electrical and Electronic Components

*Click to view similar products for [Standard Clock Oscillators](#) category:*

*Click to view products by [Abracon](#) manufacturer:*

Other Similar products are found below :

[601252](#) [F335-25](#) [F535L-33.333](#) [F535L-50](#) [NBXHBA019LN1TAG](#) [SiT1602BI-22-33E-50.000000E](#) [SIT8918AA-11-33S-50.000000G](#)  
[SM4420TEV-40.0M-T1K](#) [F335-24](#) [F335-40](#) [F535L-10](#) [F535L-12](#) [F535L-24](#) [F535L-27](#) [PE7744DW-100.0M](#) [ASF1-3.686MHZ-N-K-S](#) [ASV-](#)  
[4.000MHZ-LCS-T](#) [XLH735025.000JU4I8](#) [XLP725125.000JU6I8](#) [XO57CTECNA3M6864](#) [601251](#) [SiT8503AI-18-33E-0.200000X](#)  
[SIT8918AA-11-33S-16.000000G](#) [SIT9122AI2C233E300.000000X](#) [9120AC-2D2-33E212.500000](#) [9102AI-243N25E100.00000](#) [8208AC-82-](#)  
[18E-25.00000](#) [8008AI-72-XXE-24.545454E](#) [8004AC-13-33E-133.33000X](#) [AS-4.9152-16-SMD-TR](#) [ASFL1-48.000MHZ-LC-T](#)  
[632L3I004M00000](#) [SIT8920AM-31-33E-25.0000](#) [DSC1028DI2-019.2000](#) [9121AC-2C3-25E100.00000](#) [9102AI-233N33E100.00000X](#)  
[9102AI-233N25E200.00000](#) [9102AI-232H25S125.00000](#) [9102AI-133N25E200.00000](#) [9102AC-283N25E200.00000](#) [9001AC-33-33E1-30.000](#)  
[8103AC-13-33E-12.00000X](#) [3921AI-2CF-33NZ125.000000](#) [5730-1SF](#) [XUN736000.032768I](#) [ASV-25.000MHZ-ECS-50-T](#) [EC3925ETTTS-](#)  
[100.000M TR](#) [SIT1602BC-83-33E-10.000000Y](#) [8003AI-12-33S-40.00000Y](#) [1602BI-13-33S-19.200000E](#)