

LOW JITTER PIN CONFIGURABLE DUAL CMOS OUTPUT ULTRA MINIATURE PURE SILICON™ CLOCK OSCILLATOR

ASEMDC

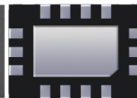

3.2 x 2.5 x 0.85 mm

ASEMDC



RoHS/RoHS II compliant

Moisture Sensitivity Level – MSL 1

FEATURES:

- Ultra Miniature Pure Silicon™ Clock Oscillator
- Pin Configurable Dual CMOS output
- Low Jitter (Period Jitter RMS 3ps typical)
- Low Integrated Phase Jitter 2ps max
- Excellent Shock & Vibration Immunity

APPLICATIONS:

- Consumer Electronics
- Storage Area Networks
- SATA, SAS, Fibre Channel
- Passive Optical Networks
- EPON, 10G-EPON, GPON, 10G-PON
- Ethernet
- 1G, 10GBASE-T/KR/LR/SR, and FCoE
- PCI Express

Low Jitter
Pin Configurable
Dual CMOS Output
3G MEMS

STANDARD SPECIFICATIONS:

Pre-programmed Output Frequency Configuration

Ordering Info	Freq (MHz)	Freq Select Bits [FS2, FS1, FS0] – Default is [111]							
		000	001	010	011	100	101	110	111
Frequency Configuration 1	f _{OUT1}	27	25	50	54	48	24	24	24
	f _{OUT2}	24	125	125	27	24	50	54	27
Frequency Configuration 2	f _{OUT1}	106.25	100	125	100	156.25	156.25	125	156.25
	f _{OUT2}	25	100	50	50	25	125	25	156.25
Custom Configuration	f _{OUT1}	Contact Abracon for customized configurations							
	f _{OUT2}								

Frequency select bits [FS2, FS1, FS0] are weakly tied high so if left floated, the default setting will be [111] and the device will output the associated frequency highlighted in Bold. If other frequency combinations are required, please contact Abracon for customized configuration. Please see the configurable frequency range in the section 2.0

Key Electrical Specifications

Parameters	Minimum	Typical	Maximum	Units	Notes
Configurable frequency range	10	-----	170	MHz	Commercial, Industrial temp range
	10	-----	100		Automotive temp range
Operating Temperature	-20	-----	+70	°C	See options
Storage Temperature	-55	-----	+150	°C	
Overall Frequency Stability*1	-50	-----	+50	ppm	See options
Supply Voltage (V _{dd})	+2.25	-----	+3.6	V	
Startup Time	-----	-----	5	ms	
Enable Time	-----	-----	20	ns	
Disable Time	-----	-----	5	ns	
Disable Current	-----	21	23	mA	
Tri-state Function (Standby/Disable)	"1" (V _{IH} ≥ 0.75*V _{dd}) or Open: Oscillation "0" (V _{IL} < 0.25*V _{dd}) : Hi Z			V	40kΩ pull-up resistor embedded
Aging	-5.0	-----	+5.0	ppm	First year
Supply Current (I _{dd})	-----	32	-----	mA	CL=15pF, 125MHz
Output Logic Level	V _{OH}	0.9*V _{dd}	-----	V	I=±6mA
	V _{OL}	-----	0.1*V _{dd}		
Rise Time	-----	1.1	2.0	ns	CL=15pF
Fall Time	-----	1.4	2.0	ns	20% to 80%
Duty Cycle	45	-----	55	%	

*1. Frequency stability includes frequency variations due to initial tolerance, temp. and power supply voltage

ABRACON IS
ISO9001:2008
CERTIFIED



ABRACON
CORPORATION

Visit www.abracon.com for Terms & Conditions of Sale **Revised: 11.05.14**
30332 Esperanza, Rancho Santa Margarita, California 92688
tel 949-546-8000 | fax 949-546-8001 | www.abracon.com

LOW JITTER PIN CONFIGURABLE DUAL CMOS OUTPUT ULTRA MINIATURE PURE SILICON™ CLOCK OSCILLATOR

ASEMDC

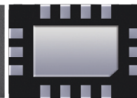

3.2 x 2.5 x 0.85 mm

ASEMDC



RoHS/RoHS II compliant

Key Electrical Specifications (continued)

Parameters	Minimum	Typical	Maximum	Units	Notes
Period Jitter RMS (J_{PER})	----	3.0	----	ps	F01=F02= 125MHz
Integrated Phase Jitter (J_{PH})	----	0.30	2	ps	200kHz ~ 20MHz, 125MHz
	----	0.38	2		100kHz ~ 20MHz, 125MHz
	----	1.70	2		12kHz ~ 20MHz, 125MHz

PHASE JITTER

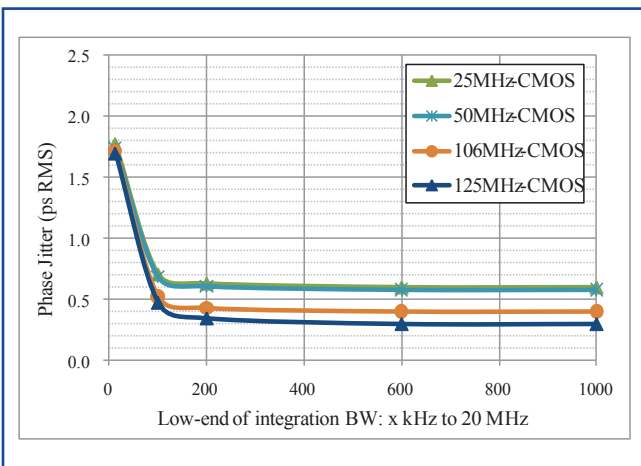

ABSOLUTE MAXIMUM RATINGS:

Item	Minimum	Maximum	Unit	Condition
Supply Voltage	-0.3	+4.0	V	
Input Voltage	-0.3	$V_{dd}+0.3$	V	
Junction Temp.	----	+150	°C	
Storage Temp.	-55	+150	°C	
Soldering Temp.	----	+260	°C	40sec max
ESD			V	
HBM		4,000		
MM		200		
CDM		1,500		

OPTIONS AND PART IDENTIFICATION:

(left blank if standard)

ASEMDC□-□-□-□

Frequency Combination (See table below)	Operating Temp.	Overall Freq. Stability	Packaging
Blank: Cfg. 1	Blank: -20°C ~ +70°C	Blank: ±50ppm	Blank: Tube (110pcs / Tube)
1: Cfg. 1	L: -40°C ~ +85°C	R: ±25 ppm	T: Tape & Reel(1kpcs / reel)
2: Cfg. 2	X: -40°C ~ +105°C		T3: Tape & Reel(3kpcs / reel)
	Z: -55°C ~ +125°C		T5: Tape & Reel(5kpcs / reel)

Frequency Combination	Freq (MHz)	Freq Select Bits [FS2, FS1, FS0] – Default is [111]							
		000	001	010	011	100	101	110	111
Configuration 1	f_{OUT1}	27	25	50	54	48	24	24	24
	f_{OUT2}	24	125	125	27	24	50	54	27
Configuration 2	f_{OUT1}	106.25	100	125	100	156.25	156.25	125	156.25
	f_{OUT2}	25	100	50	50	25	125	25	156.25
Custom Configuration	f_{OUT1}	Contact Abracon for customized configurations							
	f_{OUT2}								

Default condition: Frequency select bits [FS2, FS1, FS0] are all left floated. FS2, FS1, FS0 are pulled high [111]
Frequency combination and default frequency is customized upon request. Please contact Abracon for the frequency combinations.

ABRACON IS
ISO9001:2008
CERTIFIED



Visit www.abracon.com for Terms & Conditions of Sale **Revised: 11.05.14**
30332 Esperanza, Rancho Santa Margarita, California 92688
tel 949-546-8000 | fax 949-546-8001 | www.abracon.com

LOW JITTER PIN CONFIGURABLE DUAL CMOS OUTPUT ULTRA MINIATURE PURE SILICON™ CLOCK OSCILLATOR

ASEMDC

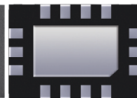

3.2 x 2.5 x 0.85 mm

ASEMDC



RoHS/RoHS II compliant

CONFIGURABLE OUTPUT STRENGTH (Tr/Tf)

Output (Tr/Tf) are configurable by the control pins OxS1 and OxS0. The combinations are described in the table below. (O1S1 and O1S0 are for output 1. O2S1 and O2S0 are for output 2)

Output Drive Strength Bits [O1S1, O1S0], [O2S1, O2S0] - Default [11]				
	00	01	10	11
Tr (ns)	1.6	1.4	1.2	1.1
Tf (ns)	2.4	2.2	1.5	1.4

MECHANICAL DIMENSIONS

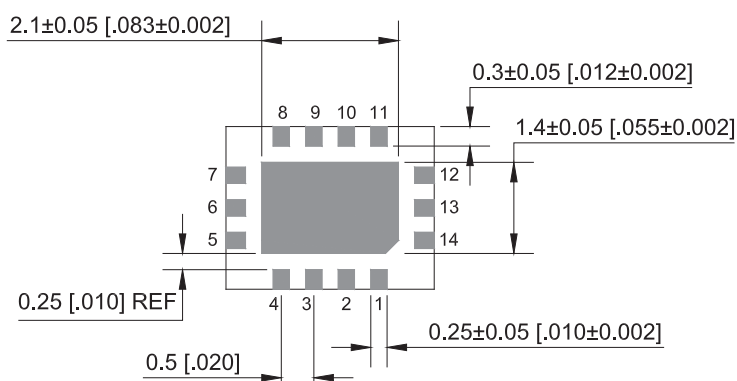
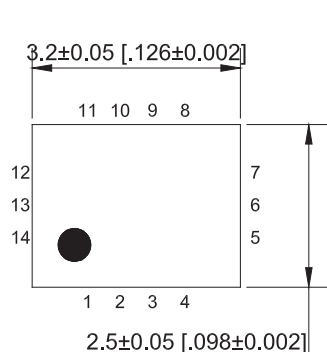

Center pad: NC/GND

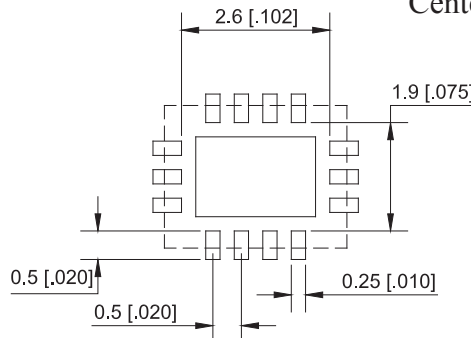
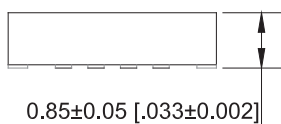

Recommended Land Pattern

Pin No.	Pin Name	Pin Type	Description
1	Enable	I	Enables outputs when high and disables (tri-state) them when low
2	NC	NA	Leave unconnected or grounded
3	O2S0	I	Least significant bit for output drive strength selection for Output 2
4	GND	Power	Ground
5	FS0	I	Least significant bit for frequency selection
6	FS1	I	Middle bit for frequency selection
7	FS2	I	Most significant bit for frequency selection
8	Fout1	O	CMOS output 1
9	O1S0	I	Least significant bit for output drive strength selection for output 1
10	O1S1	I	Most significant bit for output drive strength selection for output 1
11	Fout2	O	CMOS output 2
12	VDD2	Power	Power Supply for Output 2
13	VDD	Power	Power Supply
14	O2S1	I	Most significant bit for output drive strength selection for output 2

Dimensions: mm (inches)

ABRACON IS
ISO9001:2008
CERTIFIED



ABRACON
CORPORATION

Visit www.abracon.com for Terms & Conditions of Sale **Revised: 11.05.14**
30332 Esperanza, Rancho Santa Margarita, California 92688
tel 949-546-8000 | fax 949-546-8001 | www.abracon.com

LOW JITTER PIN CONFIGURABLE DUAL CMOS OUTPUT ULTRA MINIATURE PURE SILICON™ CLOCK OSCILLATOR

ASEMDC

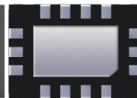

3.2 x 2.5 x 0.85 mm

ASEMDC



RoHS/RoHS II compliant

REFLOW PROFILE

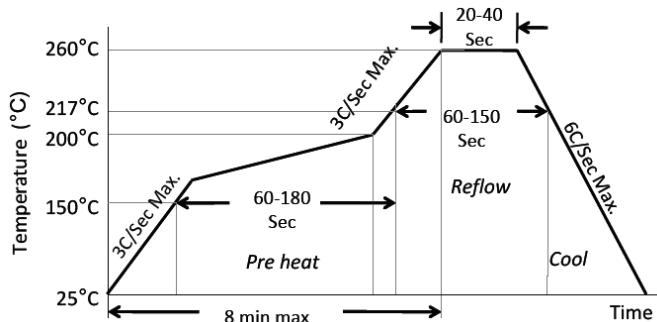

Ramp-Up Rate (200°C to Peak Temp)	3°C/Sec Max.
Preheat Time 150°C to 200°C	60-180 Sec
Time maintained above 217°C	60-150 Sec
Peak Temperature	255-260°C
Time within 5°C of actual Peak	20-40 Sec
Ramp-Down Rate	6°C/Sec Max.
Time 25°C to Peak Temperature	8 min Max.

TAPE & REEL:

T= 1,000pcs/reel (D=180mm)
T3= 3,000pcs/reel (D=180mm)
T5= 5,000pcs/reel (D=330mm)

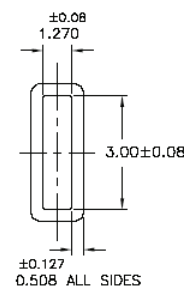
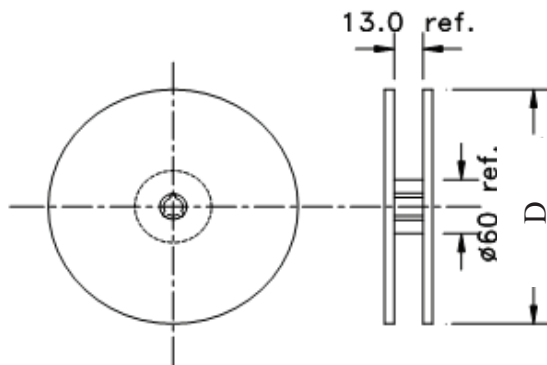
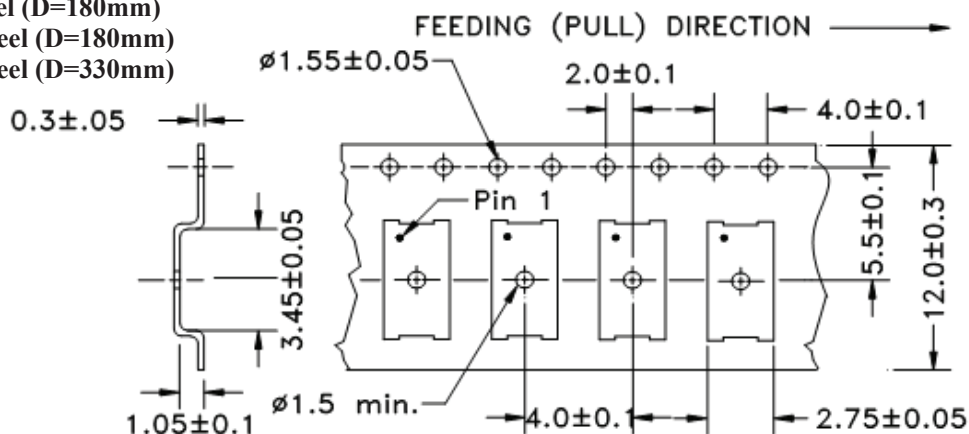

Tube: 110 pcs/tube

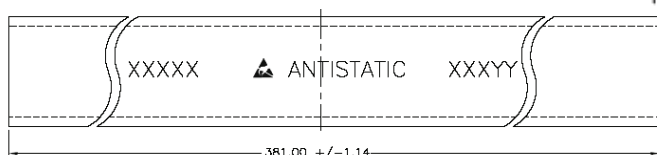

Unit orientation in tube:



Dimensions: mm

ATTENTION: Abracon Corporation's products are COTS – Commercial-Off-The-Shelf products; suitable for Commercial, Industrial and, where designated, Automotive Applications. Abracon's products are not specifically designed for Military, Aviation, Aerospace, Life-dependant Medical applications or any application requiring high reliability where component failure could result in loss of life and/or property. For applications requiring high reliability and/or presenting an extreme operating environment, written consent and authorization from Abracon Corporation is required. Please contact Abracon Corporation for more information.

ABRACON IS
ISO9001:2008
CERTIFIED



**ABRACON
CORPORATION**

Visit www.abracon.com for Terms & Conditions of Sale **Revised: 11.05.14**
30332 Esperanza, Rancho Santa Margarita, California 92688
tel 949-546-8000 | fax 949-546-8001 | www.abracon.com

X-ON Electronics

Largest Supplier of Electrical and Electronic Components

Click to view similar products for [Standard Clock Oscillators](#) category:

Click to view products by [ABRACON](#) manufacturer:

Other Similar products are found below :

[EP1400SJTSC-125.000M](#) [601137](#) [601252](#) [CSX750FBC-24.000M-UT](#) [CSX750FBC-33.333M-UT](#) [CSX750FCC-3.6864M-UT](#) [F335-12](#) [F335-25](#) [F535L-50](#) [DSC506-03FM2](#) [ASA-20.000MHZ-L-T](#) [ASA-25.000MHZ-L-T](#) [ASA-27.000MHZ-L-T](#) [ASV-20.000MHZ-LR-T](#) [ECS-2018-160-BN-TR](#) [EL13C7-H2F-125.00M](#) [MXO45HS-2C-66.6666MHZ](#) [NBXDBB017LN1TAG](#) [NBXHBA019LN1TAG](#) [SiT1602BI-22-33E-50.000000E](#) [SIT8003AC-11-33S-2.04800X](#) [SiT8256AC-23-33E-156.250000X](#) [SIT8918AA-11-33S-50.000000G](#) [SM4420TEV-40.0M-T1K](#) [SMA4306-TL-H](#) [F335-24](#) [F335-40](#) [F335-50](#) [F535L-10](#) [F535L-12](#) [F535L-16](#) [F535L-24](#) [F535L-27](#) [F535L-48](#) [PE7744DW-100.0M](#) [CSX750FBC-20.000M-UT](#) [CSX-750FBC33333000T](#) [CSX750FBC-4.000M-UT](#) [CSX750FBC-7.3728M-UT](#) [CSX750FBC-8.000M-UT](#) [CSX-750FCC14745600T](#) [CSX750FCC-16.000M-UT](#) [CSX-750FCC40000000T](#) [CSX750FCC-4.000M-UT](#) [ASA-22.000MHZ-L-T](#) [ASA2-26.000MHZ-L-T](#) [ASA-40.000MHZ-L-T](#) [ASA-48.000MHZ-L-T](#) [ASA-60.000MHZ-L-T](#) [ASF1-3.686MHZ-N-K-S](#)