

ASFLMP



RoHS/RoHS II compliant

Moisture Sensitivity Level- MSL 1

FEATURES:

- Low Power Consumption for high speed communication
- Exceptional Stability Over Temp. at -40 to +85°C, ±15ppm
- Extended Automotive Grade Temp. stability at -55 to +125°C, ±25ppm
- MIL-STD-883 shock and vibration compliant
- Durable QFN Plastic Compact Packaging
- Standby or Disable Tri-state function
- Low jitter (Period jitter RMS and Phase jitter RMS)
- High power supply noise reduction, -50dBc

APPLICATIONS:

- Storage Area Networks (SATA, SAS, Fiber Channel)
- Passive Optical Networks (EPON, 10G-EPON, GPON, 10G-PON)
- Ethernet (1G, 10GBASE-T, KR/LR/SR, FCoE)
- PCI Express
- Display port

STANDARD SPECIFICATIONS:

Key Electrical Specifications – CMOS, LVPECL, LVDS, and HCSL

Parameters	Minimum	Typical	Maximum	Units	Notes	
Frequency Range	CMOS	2.3000*		170.0000	MHz	-20 ~ +70°C -40 ~ +85°C
	CMOS	3.3000*		170.0000		-40 ~ +105°C -55 ~ +125°C
	LVPECL	2.3000*		460.0000		Commercial, Industrial temp. range
	LVDS	2.3000*		460.0000		Commercial, Industrial temp. range
	HCSL	2.3000*		460.0000		Commercial, Industrial temp. range
Operating Temperature	-20		+70	°C	See options	
Storage Temperature	-55		+150	°C		
Overall Frequency Stability	-50		+50	ppm	See options	
Supply Voltage (Vdd)	+2.25		+3.6	V		
Startup Time			5	ms		
Enable Time			20	ns	STD (Tri-state)	
			5	ms	PD option (Power Down)	
Disable Time			5	ns		
Disable Current		20	22	mA	STD (Tri-state)	
			0.095		PD option (Power Down)	
Tri-state Function (Standby/Disable)	"1" (VIH ≥ 0.75 * Vdd) or Open: Oscillation "0" (VIL < 0.25 * Vdd) : Hi Z			V	40kΩ pull-up resistor embedded	
Aging	-5.0		+5.0	ppm	First year	

* For 2.3000MHz < F0 < 9.9999MHz, 6-8 weeks lead-time applies

Key Electrical Specifications – CMOS

Parameters	Minimum	Typical	Maximum	Units	Notes
Supply Current (I _{dd})		31	35	mA	CL=15pF, 125MHz
Output Logic Level	V _{OH}	0.9 * V _{dd}		V	I = ±6mA
	V _{OL}		0.1 * V _{dd}	V	
Rise Time	Tr	1.1	2.0	ns	CL=15pF
Fall Time	Tf	1.3	2.0	ns	20% to 80%
Duty Cycle		45	55	%	
Integrated Phase Jitter (J _{PH})		0.30	2	ps	200kHz ~ 20MHz@125MHz
		0.38	2		100kHz ~ 20MHz@125MHz
		1.70	2		12kHz ~ 20MHz@125MHz
Period Jitter RMS (J _{PER})		3.0		ps	

REVISED: 11.30.2018



Key Electrical Specifications – LVPECL

Parameters		Minimum	Typical	Maximum	Units	Notes
Supply Current (I_{dd})			56.5	58	mA	RL=50Ω
Output Logic Level	V_{OH}	$V_{dd}-1.08$			V	RL=50Ω
	V_{OL}			$V_{dd}-1.55$	V	
Peak to Peak Output Swing (V_{pp})			800		mV	Single ended
Rise Time	T_r		250		ps	RL=50Ω , CL=0pF 20% to 80%
Fall Time	T_f		250			
Duty Cycle		48		52	%	Differential
Integrated Phase Jitter (J_{PH})			0.25	2	ps	200kHz ~ 20MHz @156.25MHz
			0.38	2		100kHz ~ 20MHz @156.25MHz
			1.70	2		12kHz ~ 20MHz @156.25MHz
Period Jitter RMS (J_{PER})			2.5		ps	

Key Electrical Specifications – LVDS

Parameters		Minimum	Typical	Maximum	Units	Notes
Supply Current (I_{dd})			29	32	mA	RL=100Ω
Output Offset Voltage (V_{OS})		1.125		1.4	V	RL=100Ω differential
Delta Offset Voltage (ΔV_{OS})				50	mV	
Peak to Peak Output Swing (V_{pp})			350		mV	Single ended
Rise Time	T_r		200		ps	RL=50Ω , CL=2pF 20% to 80%
Fall Time	T_f		200			
Duty Cycle		48		52	%	Differential
Integrated Phase Jitter (J_{PH})			0.28	2	ps	200kHz ~ 20MHz @156.25MHz
			0.40	2		100kHz ~ 20MHz @156.25MHz
			1.70	2		12kHz ~ 20MHz @156.25MHz
Period Jitter RMS (J_{PER})			2.5		ps	

Key Electrical Specifications – HCSL

Parameters		Minimum	Typical	Maximum	Units	Notes
Supply Current (I_{dd})			40	42	mA	RL=50Ω
Output Logic Level	V_{OH}	0.725			V	RL=50Ω
	V_{OL}			0.1	V	
Peak to Peak Output Swing (V_{pp})			750		mV	Single ended
Rise Time	T_r	200		400	ps	RL=50Ω , CL=2pF 20% to 80%
Fall Time	T_f	200		400		
Duty Cycle		48		52	%	Differential
Integrated Phase Jitter (J_{PH})			0.25	2	ps	200kHz ~ 20MHz @156.25MHz
			0.37	2		100kHz ~ 20MHz @156.25MHz
			1.70	2		12kHz ~ 20MHz @156.25MHz
Period Jitter RMS (J_{PER})			2.5		ps	



Absolute Maximum Ratings

Item	Minimum	Maximum	Unit	Condition
Supply Voltage	-0.3	+4.0	V	
Input Voltage	-0.3	V _{dd} +0.3	V	
Junction Temp.		+150	°C	
Storage Temp.	-55	+150	°C	
Soldering Temp.		+260	°C	40sec max
ESD			V	
HBM		4,000		
MM		400		
CDM		1,500		

OPTIONS AND PART IDENTIFICATION: (Left Blank if Standard)

Programmed Orders (Quantity > 1,000pcs)

ASFLMP [] - [] MHz - [] [] - [] []

Output Type	Frequency in MHz	Operating Temp.	Overall Freq. Stability	Tri-state (Pin 1)	Packaging
C: CMOS	e.g. 156.2500 MHz (Maximum 4 digits after decimal)	Blank: -20°C ~ +70°C	Blank: ±50ppm	Blank: Tri-state	Blank***: Tube (72pcs / Tube)
LP: LVPECL		L: -40°C ~ +85°C	Y: ±10ppm*	PD: Power Down	T: Tape & Reel (1kpcs / reel)
LV: LVDS		X: -40°C ~ +105°C	R: ±25 ppm		T3: Tape & Reel (3kpcs / reel)
HC: HCSL		Z**: -55°C ~ +125°C			

* Temp option L, X or -20°C ~ +70°C, only

** CMOS output only

*** For Quick turn-around programmable orders < 1000pcs: Due to the immediate availability of stock and the qty of the order, the parts may be delivered as BULK: Cut Tape, Loose parts in Antistatic Bag or in Tube(s). The MOQ per the series will still apply for Tube packaging.

Un-Programmed Orders

Blank un-programmed oscillators are available for quick turn engineering requirements. Please call ABRACON for more information.

ASFLMP [] - BLANK - [] [] - [] []

Output Type	Operating Temp.	Overall Freq. Stability	Tri-state (Pin 1)	Packaging
C: CMOS	Blank: -20°C ~ +70°C	Blank: ±50ppm	Blank: Tri-state	Blank: Tube (72pcs / Tube)
LP: LVPECL	L: -40°C ~ +85°C	Y: ±10ppm*	PD: Power Down	T: Tape & Reel (1kpcs / reel)
LV: LVDS	X: -40°C ~ +105°C	R: ±25 ppm		T3: Tape & Reel (3kpcs / reel)
HC: HCSL	Z**: -55°C ~ +125°C			

* Temp option L, X or -20°C ~ +70°C, only

** CMOS output only



NOMINAL PERFORMANCE PARAMETERS

(Unless specified otherwise: T=25° C, VDD=3.3 V)

CMOS OUTPUT

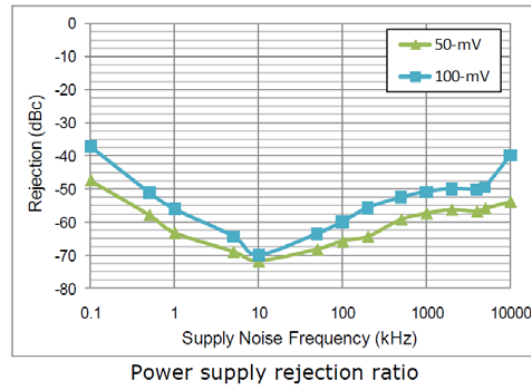
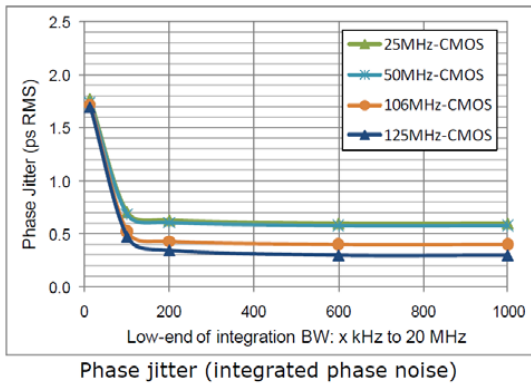

Test Circuit

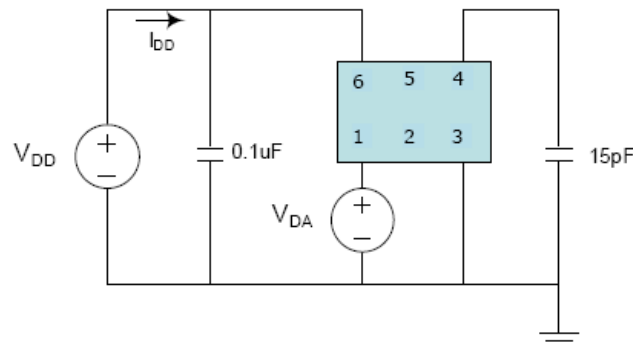

LVPECL output

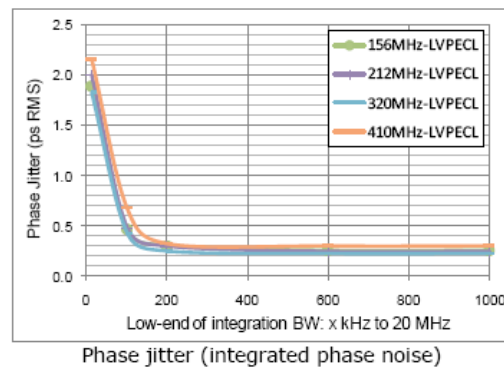
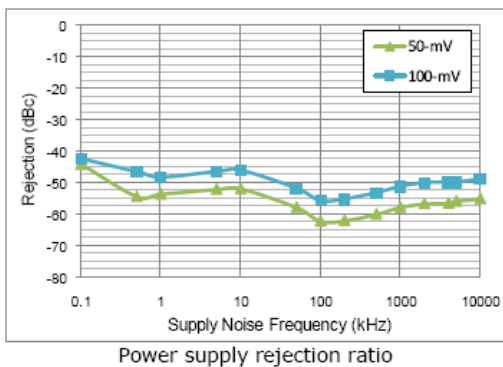

Test Circuit

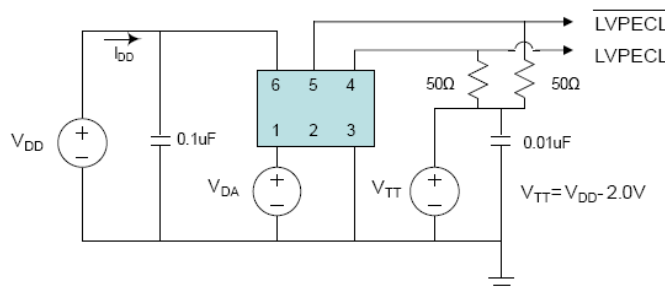



LVDS output

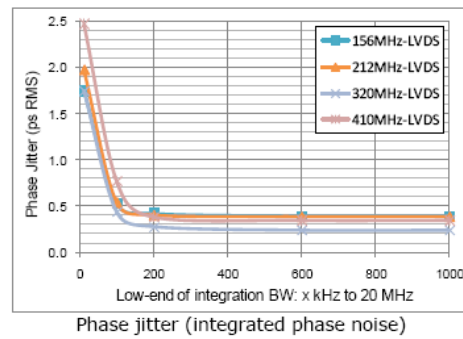
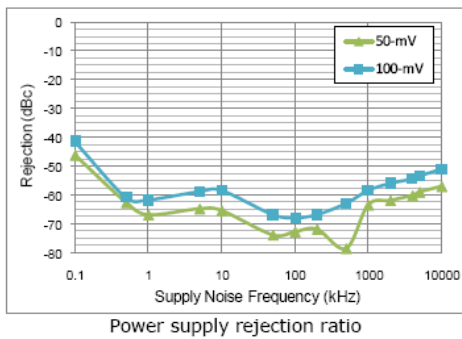

Test Circuit

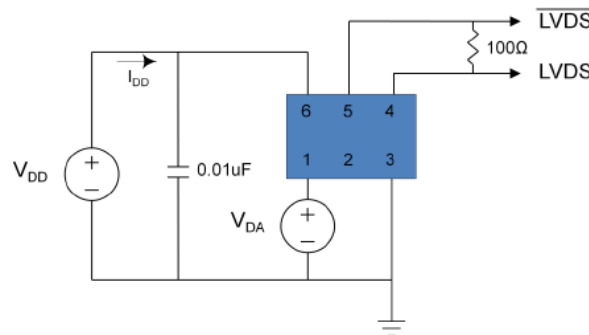

HCSL output

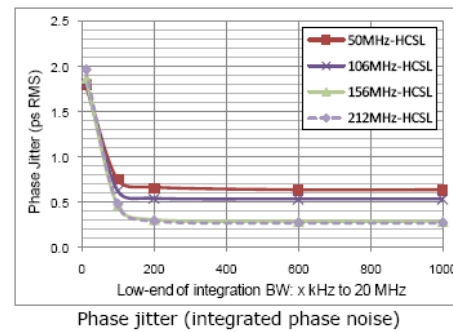
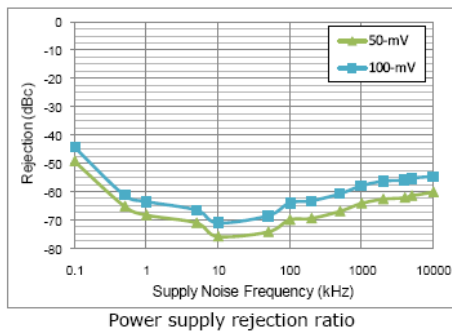

Test Circuit

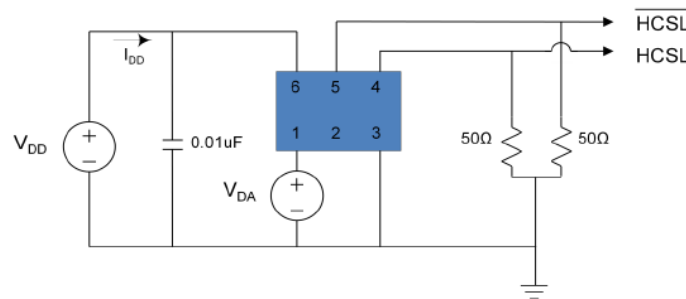

MEMS CLOCK OSCILLATOR

ASFLMP



ASFLMP



RoHS/RoHS II compliant

Life Size



5.0 x 3.2 x 0.85 mm

OUTLINE DIMENSIONS:

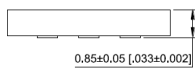
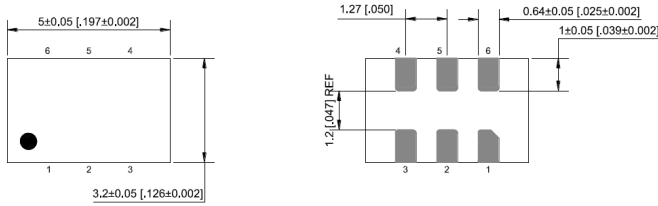

Pin #	Function
1	Tri-state
2	NC
3	GND
4	Output
5	NC (CMOS)
6	Output (LVPECL, LVDS, HCSL) Vdd

Note: Recommend using an approximately 0.01uF bypass capacitor between PIN 6 and 3.

Dimensions: mm (inches)

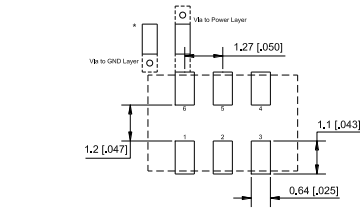
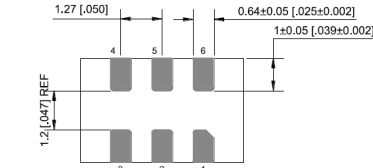

Recommended Land Pattern for LVPECL, LVDS, HCSL

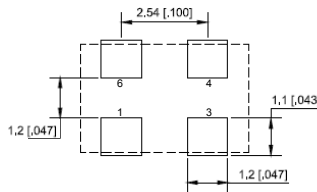

Recommended Land Pattern for CMOS

REFLOW PROFILE:

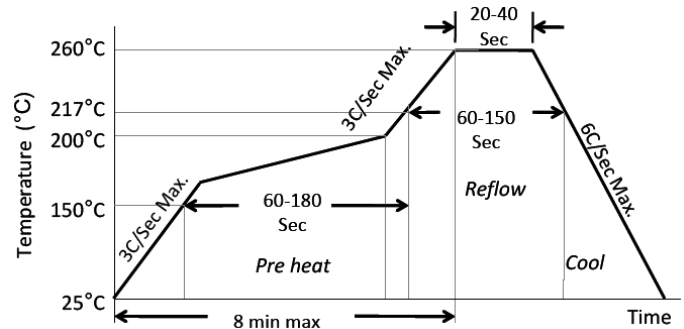

Ramp-Up Rate (200°C to Peak Temp)	3°C/Sec Max.
Preheat Time 150°C to 200°C	60-180 Sec
Time maintained above 217°C	60-150 Sec
Peak Temperature	255-260°C
Time within 5°C of actual Peak	20-40 Sec
Ramp-Down Rate	6°C/Sec Max.
Time 25°C to Peak Temperature	8 min Max.

TAPE AND REEL:

T= 1,000pcs/reel (D=180mm), T3= 3,000pcs/reel (D=330mm)

Tape 1

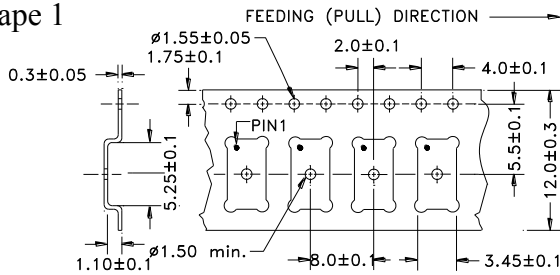

Tube: 72 pcs/tube

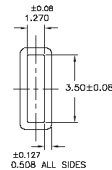

Unit orientation in tube:



Tape 2

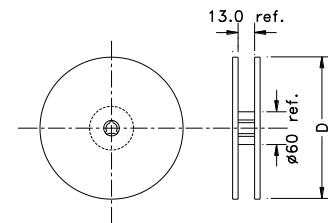
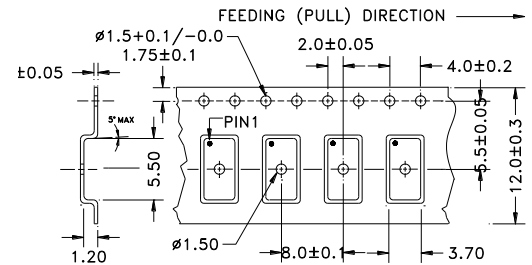

Dimensions: mm

ATTENTION: Abracon LLC's products are COTS – Commercial-Off-The-Shelf products; suitable for Commercial, Industrial and, where designated, Automotive Applications. Abracon's products are not specifically designed for Military, Aviation, Aerospace, Life-dependent Medical applications or any application requiring high reliability where component failure could result in loss of life and/or property. For applications requiring high reliability and/or presenting an extreme operating environment, written consent and authorization from Abracon LLC is required. Please contact Abracon LLC for more information.



5101 Hidden Creek Ln Spicewood TX 78669
Phone: 512-371-6159 | Fax: 512-351-8858
For terms and conditions of sales, please visit: www.abracon.com

REVISED: 11.30.2018

ABRACON IS
ISO9001-2015
CERTIFIED

X-ON Electronics

Largest Supplier of Electrical and Electronic Components

Click to view similar products for [Sockets & Adapters](#) category:

Click to view products by [ABRACON](#) manufacturer:

Other Similar products are found below :

[6508-0-00-01-00-00-33-0](#) [AC164341](#) [AC164348](#) [1262](#) [22827](#) [AC164353](#) [TDGL015](#) [SA247](#) [SM64TQ-ACTEL-1](#) [70-0036](#) [DS91230+](#)
[SMPA-ISP-ACTEL-3-KIT](#) [16017](#) [LFVDBGF](#) [KIT 70601-3](#) [SM132CQ-ACTEL](#) [IPC0181](#) [IPC0175](#) [IPC0165](#) [AC164397](#) [conga-Thin](#)
[MITX/eDP to DP Adapter](#) [ML-ADP-EVN](#) [ASA.01](#) [ASA.09](#) [ASA.12](#) [ASA.14](#) [TOOLSTICK990MPP](#) [MIKROE-425](#) [C305000ACP2](#)
[110-83-320-41-605101](#) [110-83-632-41-605101](#) [110-83-640-41-605101](#) [110-83-628-41-605101](#) [116-83-306-41-001101](#) [PA0003](#) [PA0007](#)
[PA0009](#) [PA0035](#) [PA0085](#) [PA0096](#) [IPC0079](#) [ATARD-DBGADPT](#) [80-000286](#) [ATSTK600-RC26](#) [ATSTK600-RC46](#) [ATSTK600-RC88](#)
[ATSTK600-SC06](#) [ATSTK600-RC78](#) [SPC560PADPT64S](#) [AC164345](#)