

OVERVIEW:

ASGTX temperature compensated Crystal Oscillators are designed to accommodate a broad breadth of Precision TCXO requirements, without NRE and extended lead-times. This oscillator series is designed and manufactured by Abracon Corporation and is available to order from 1pc to high volume production quantities.

- **1-5 day quick-turn availability of a TCXO/VCTCXO with LVCMOS output, Any frequency between 10MHz & 250MHz**

For example, if a reference oscillator requirement calls out 49.7521MHz; ± 1.00 ppm TCXO/VCTCXO with LVCMOS output, ASGTX can be configured and shipped within 1-5 days and in most cases, same day if order is received before noon. Customers with low-to-mid annual volume requirements find it difficult to procure custom frequency TCXO/VCTCXO's without costly NRE charges and/or long lead-times (≥ 12 weeks).

- **1-5 day quick turn availability of a TCXO/VCTCXO requiring LVDS or LVPECL Differential output, Any frequency between 10MHz to 1.50GHz**

ASGTX is available with either LVDS or LVPECL output, from 10MHz to 1.50GHz; at any desired frequency, such as 149.875MHz, 1.00GHz, 1.5GHz, etc. with as tight as ± 1.00 ppm stability over temperature. No other solution in the marketplace currently offers such capability, especially in a small form-factor of 9.0x7.0x2.24 mm.

ASGTX is suitable for a wide variety of precision timing applications where TCXO/VCTCXO's are typically employed. In addition, for high frequency LO requirements, traditionally customers have relied on SAW based oscillators. Such devices are only available at a few fixed frequencies, such as 915MHz, 1.0GHz, etc. They are typically in 9x14mm or bigger packages and vary as much as ± 100 ppm over temperature.

Although ASGTX series will be slightly less favorable in phase noise performance compared to SAW based oscillators, it offers the following key advantages:

- o ± 1.00 ppm stability over -30°C to $+70^{\circ}\text{C}$ & ± 2.00 ppm stability over -40°C to $+85^{\circ}\text{C}$
- o **Any carrier frequency** between 10MHz & 1.50GHz
- o LVCMOS Output (10MHz to 250MHz) **or** LVDS / LVPECL Output (10MHz to 1.50GHz)
- o Small form-factor of 9.0x7.0x2.24 mm
- o No NRE or lead-time

FEATURES:

- 10MHz to 1.50GHz, any Carrier Frequency in differential mode (LVDS or LVPECL)
- 10MHz to 250MHz, any Carrier Frequency in LVCMOS mode
- -40°C to $+85^{\circ}\text{C}$ operating temperature range
- ± 1.0 ppm stability over -30°C to $+70^{\circ}\text{C}$ and ± 2.0 ppm stability over -40°C to $+85^{\circ}\text{C}$
- Minimum guaranteed pull ability of ± 10 ppm in VCTCXO mode
- Good Phase Noise, excellent Harmonics and Spurious content
- Guaranteed rms jitter of 1.80ps maximum @ 1.50GHz carrier (LVDS mode)
- Immediate availability, 5-day maximum lead-time for small quantities

APPLICATIONS:

- 40G & 100G Ethernet
- WiMax,
- LTE, BTS
- CATV, LAN, LMDS
- Point-to-Point communication networks



Configurable High Performance SMD TCXO/VCTCXO

ASGTX

 RoHS/RoHS II Compliant

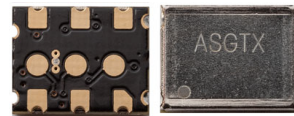

9.0 x 7.0 x 2.24 mm

KEY ELECTRICAL SPECIFICATIONS:

| Parameters | | Minimum | Typical | Maximum | Units | Notes |
|--|-------------------|---------|---------|-----------------|-------|---------------------|
| Frequency: | LVC MOS | 10 | | 250 | MHz | |
| | LVDS | 10 | | 1500 | | |
| | LVPECL | 10 | | 1500 | | |
| Operating Temperature: | | -40 | | +85 | °C | |
| Storage Temperature: | | -40 | | +85 | °C | |
| Frequency Stability: | | | | | | |
| Initial Set Tolerance | | -1.50 | ≤ ±1.00 | +1.50 | ppm | 1 hour after reflow |
| Stability over operating temperature* | -30°C to +70°C | -1.00 | | +1.00 | ppm | Option "1" |
| | -40°C to +85°C ** | -2.00 | | +2.00 | | Option "2" |
| Aging @ 25°C after one year | | -1.00 | | +1.00 | ppm | |
| Supply Voltage (V _{dd}): | | 3.135 | 3.300 | 3.465 | V | |
| Startup Time: | | | | 3 | ms | |
| Control Voltage: | | 0 | 1.55 | V _{dd} | V | In VCTCXO Mode |
| Frequency Pull: | | ±10 | | | ppm | |
| Phase jitter RMS [$t_{jit(\Box)}$] *** (12kHz to 20MHz) | | | <1.00 | 1.80 | ps | Frequency dependent |

Notes

* *Relative to measured frequency post reflow*

** *Please contact Abracon for ±1.00 ppm frequency stability over -40°C to +85°C*

*** *1.8ps max is guaranteed for LVC MOS and LVDS output modes. For LVPECL mode at carrier frequency greater than 1.289GHz, the maximum RMS jitter is 3.0ps*

Key Electrical Specifications – LVC MOS

| Parameters | | Minimum | Typical | Maximum | Units | Notes |
|------------------------------------|-----------------|---------------------|---------|---------------------|-------|---------------------|
| Supply Current (I _{dd}): | | | | 45 | mA | Frequency dependent |
| Output Load: | | | | 15 | pF | |
| Output Logic Level: | V _{OH} | 0.9*V _{dd} | | | V | |
| | V _{OL} | | | 0.1*V _{dd} | V | |
| Rise Time (Tr): | | | | 1000 | ps | |
| Fall Time (Tf): | | | | 1000 | ps | |
| Duty Cycle: | | 45 | | 55 | % | @1/2V _{dd} |

Configurable High Performance SMD TCXO/VCTCXO

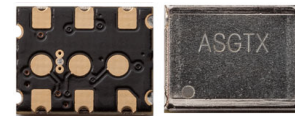

9.0 x 7.0 x 2.24 mm

ASGTX

RoHS/RoHS II Compliant

Key Electrical Specifications – LVPECL

| Parameters | Minimum | Typical | Maximum | Units | Notes | |
|-----------------------------|----------|---------------|---------|---------------|--|--|
| Supply Current (I_{dd}) | | | 60 | mA | With typical LVPECL output termination | |
| Output Logic Level | V_{OH} | $V_{dd}-1.03$ | | $V_{dd}-0.60$ | V | |
| | V_{OL} | $V_{dd}-1.85$ | | $V_{dd}-1.60$ | V | |
| Rise Time (T_r): | | | 350 | ps | | |
| Fall Time (T_f): | | | 350 | ps | | |
| Differential Duty Cycle: | 45 | | 55 | % | $DODC_{LVPECL}$ | |

Key Electrical Specifications – LVDS

| Parameters | Minimum | Typical | Maximum | Units | Notes |
|---|---------|---------|---------|-------|--------------------------------------|
| Supply Current (I_{dd}) | | | 40 | mA | With typical LVDS output termination |
| Differential Output Voltage (V_{OD}) | 175 | 350 | | mV | |
| V_{OD} Magnitude Change (ΔV_{OD}) | | | 50 | mV | |
| Offset Voltage (V_{OS}) | | 1.25 | | V | |
| V_{OS} Magnitude Change (ΔV_{OS}) | | | 50 | mV | |
| Rise Time (T_r): | | | 350 | ps | |
| Fall Time (T_f): | | | 450 | ps | |
| Differential Duty Cycle: | 45 | | 55 | % | ODC_{LVDS} |

➤ OPTIONS & PART IDENTIFICATION:

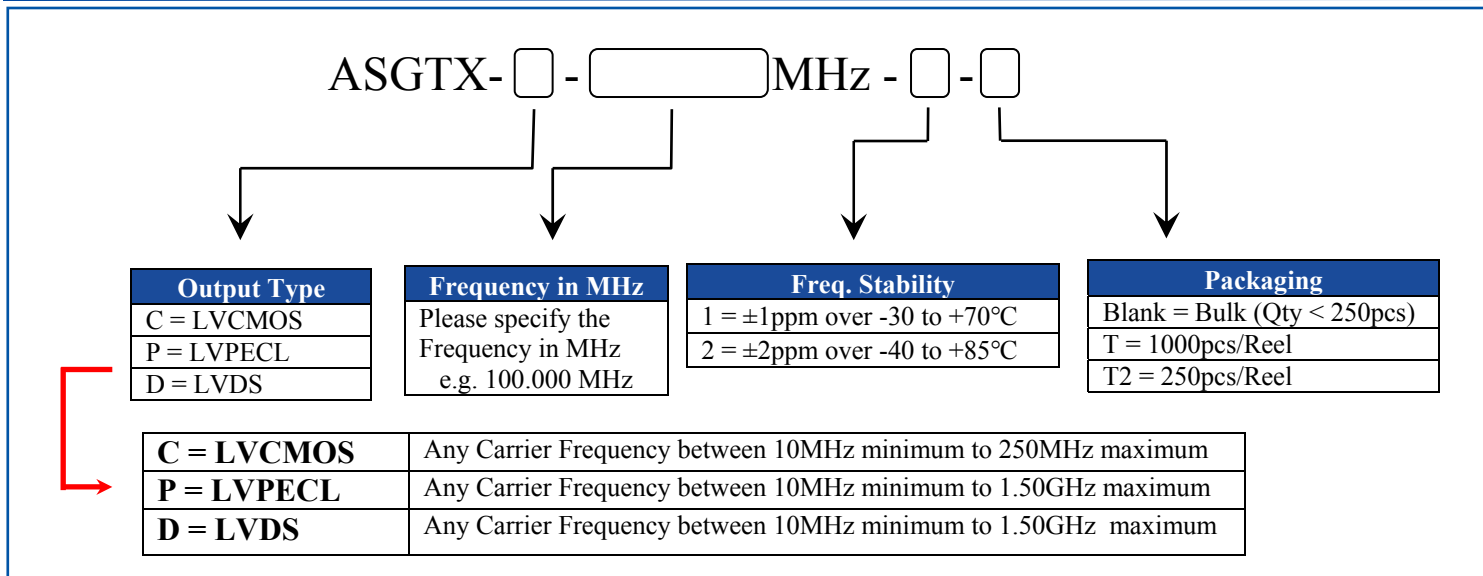

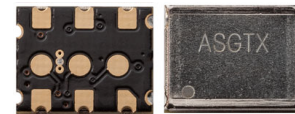

9.0 x 7.0 x 2.24 mm

ASGTX

RoHS/RoHS II Compliant

TYPICAL PHASE NOISE & JITTER CHARACTERISTICS

With LVCMOS Output; 10MHz Carrier

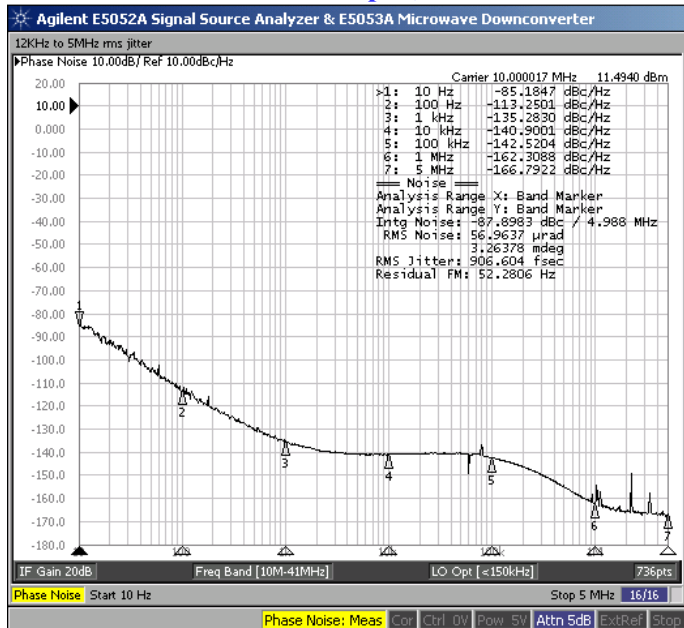

With LVDS Output; 10MHz Carrier

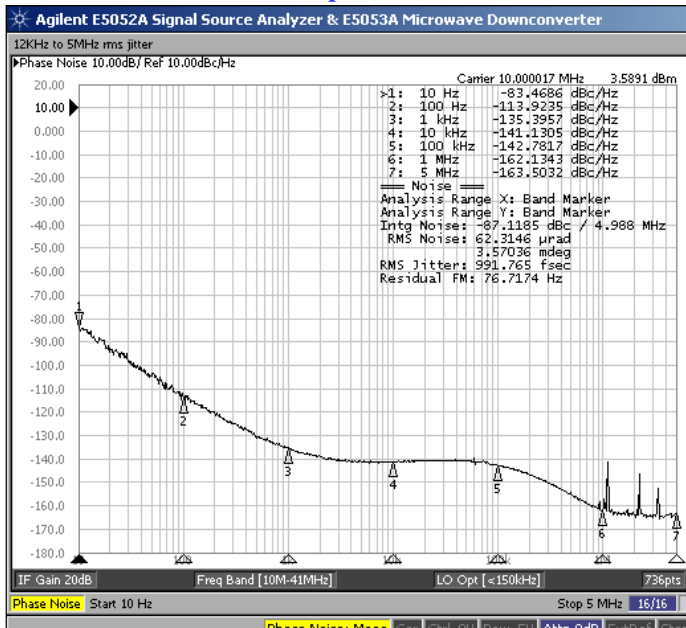

With LVCMOS Output; 25MHz Carrier

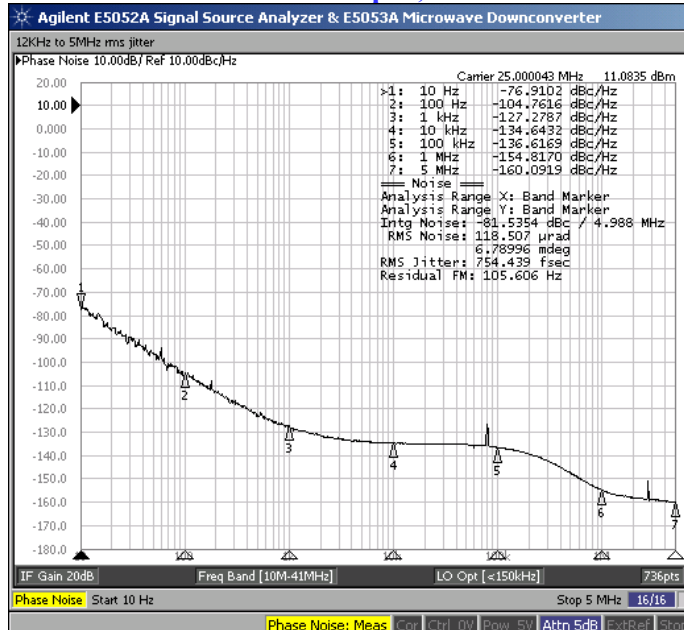

With LVDS Output; 25MHz Carrier

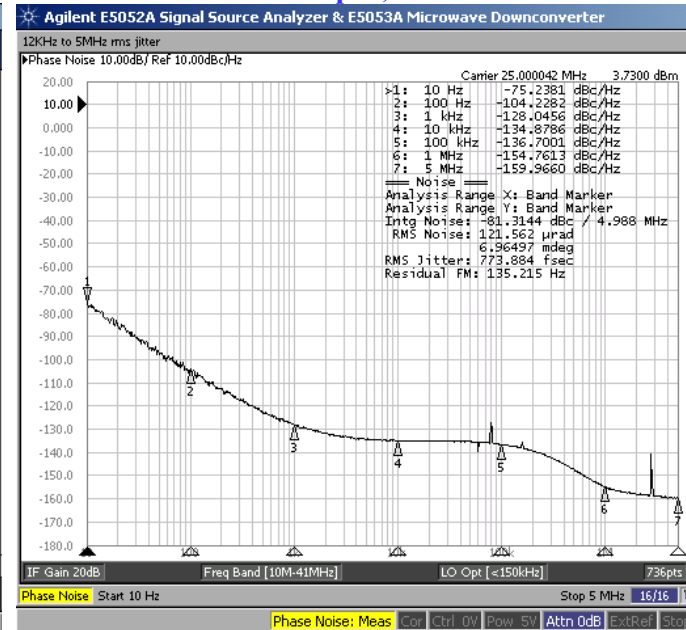

Configurable High Performance SMD TCXO/VCTCXO

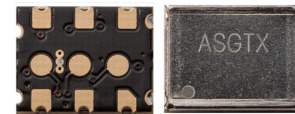

9.0 x 7.0 x 2.24 mm

ASGTX

Pb RoHS/RoHS II Compliant

TYPICAL PHASE NOISE & JITTER CHARACTERISTICS

With LVC MOS Output; 50MHz Carrier

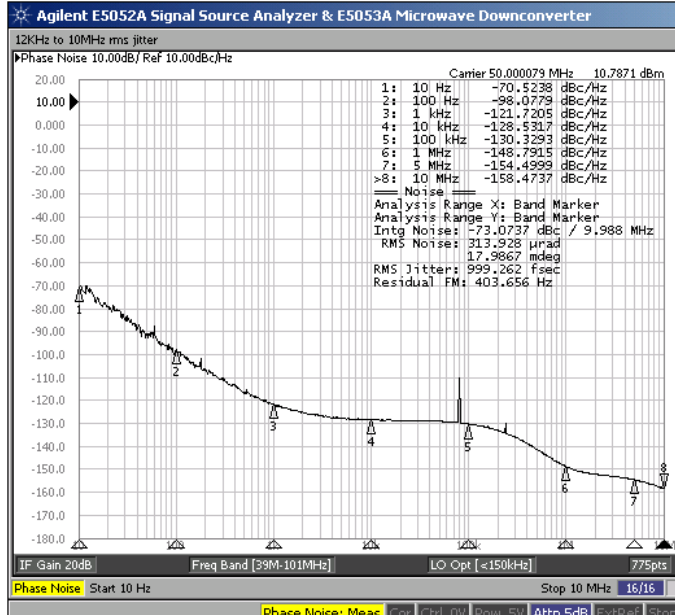

With LVDS Output; 50MHz Carrier

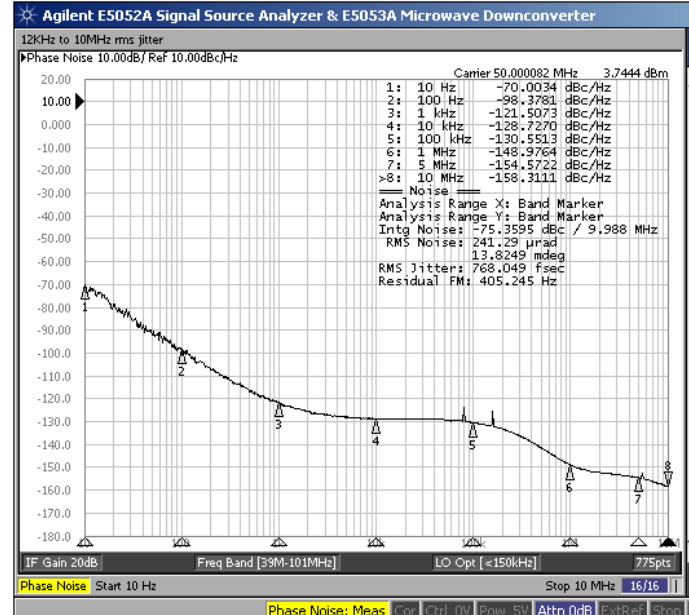

With LVC MOS Output; 120MHz Carrier

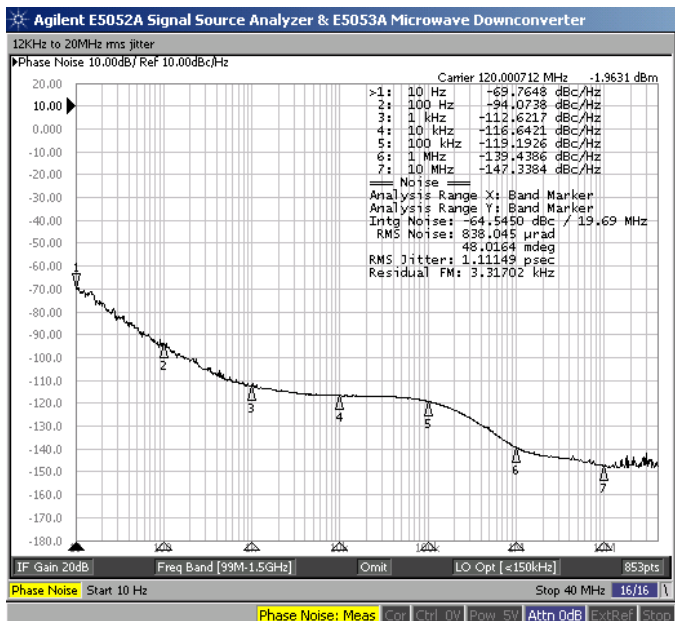

With LVPECL Output; 500MHz Carrier

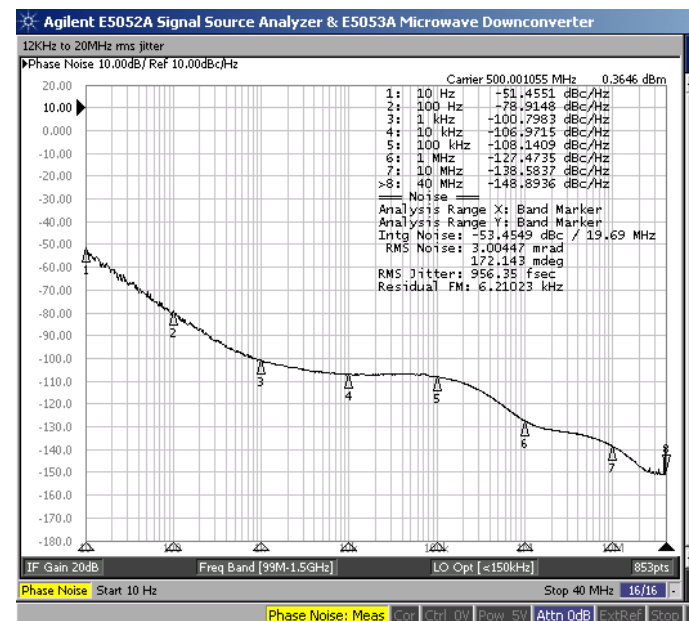

ABRACON IS
ISO9001:2008
CERTIFIED



2 Faraday, Suit#B, Irvine, California 92618 Revised: 10.16.14
tel:949-546-8000 | fax:949-546-8001
Visit www.abracon.com for Terms & Conditions of Sale

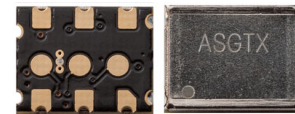

9.0 x 7.0 x 2.24 mm

ASGTX

RoHS/RoHS II Compliant

TYPICAL PHASE NOISE & JITTER CHARACTERISTICS

With LVDS Output; 1.00GHz Carrier

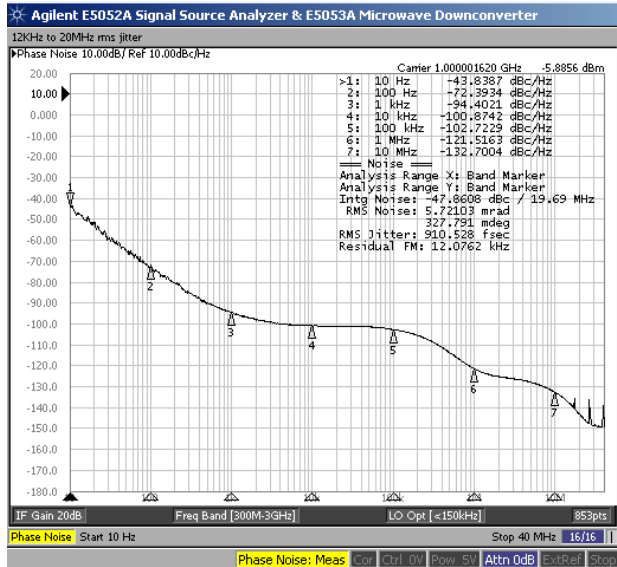

With LVDS Output; 1.2890625GHz Carrier

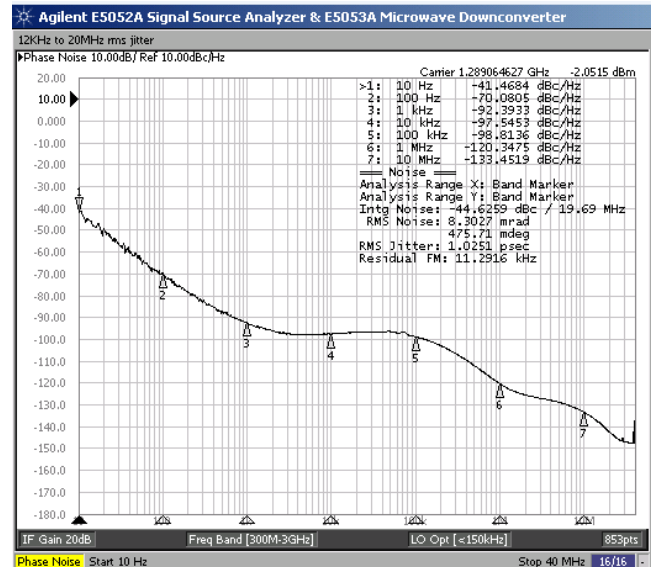

With LVDS Output; 1.50GHz Carrier

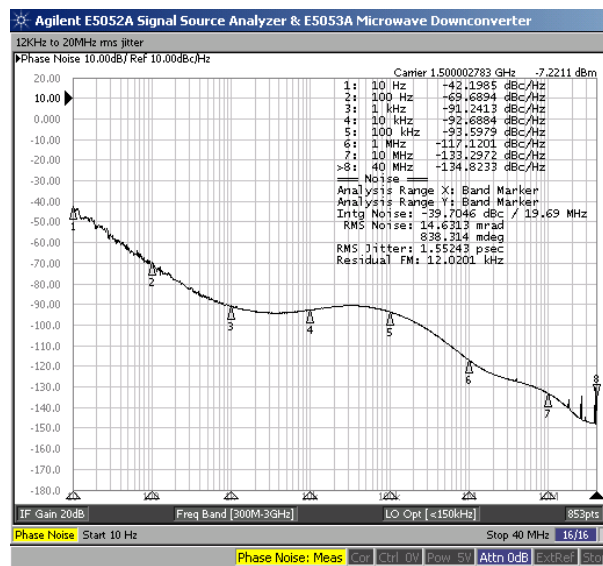

| Carrier | RF Output | rms Phase Jitter | Integration Bandwidth |
|--------------|-----------|------------------|-----------------------|
| 10.00MHz | LVDS | 992 fs | 12kHz to 5MHz |
| 25.00MHz | LVDS | 774 fs | 12kHz to 5MHz |
| 50.00MHz | LVDS | 768 fs | 12kHz to 10MHz |
| 120.00MHz | LVC MOS | 1.1 ps | 12kHz to 20MHz |
| 500.00MHz | LVPECL | 956 fs | 12kHz to 20MHz |
| 1.00GHz | LVDS | 911 fs | 12kHz to 20MHz |
| 1.2890625GHz | LVDS | 1.03 ps | 12kHz to 20MHz |
| 1.50GHz | LVDS | 1.55 ps | 12kHz to 20MHz |

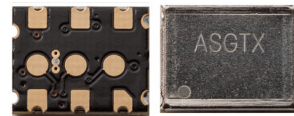

9.0 x 7.0 x 2.24 mm

ASGTX

RoHS/RoHS II Compliant

FREQUENCY STABILITY VS. TEMPERATURE

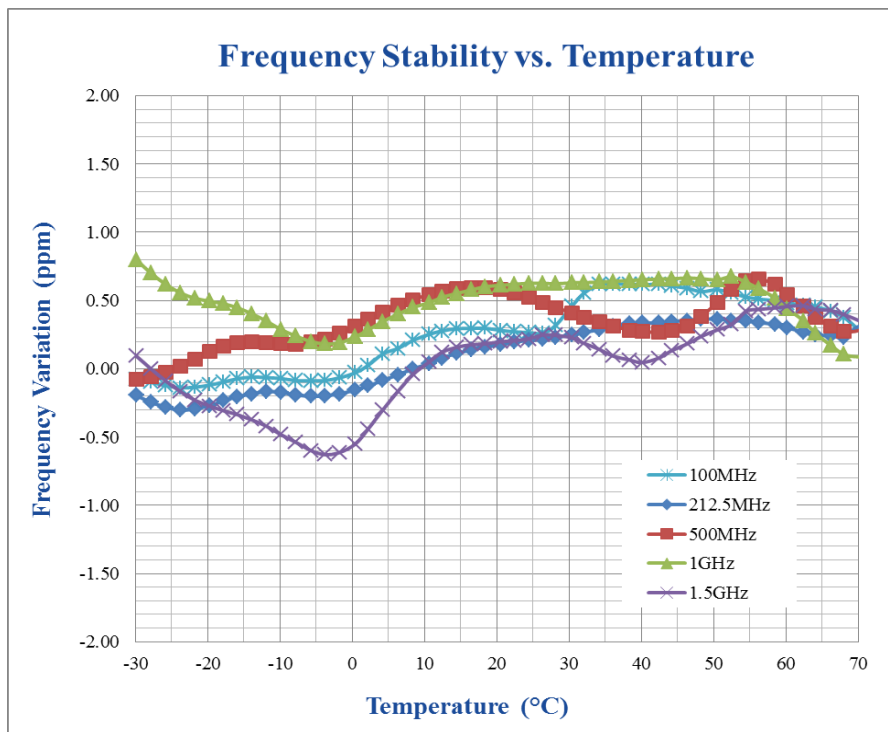

FREQUENCY PULL VS. CONTROL VOLTAGE (VCTCXO MODE)

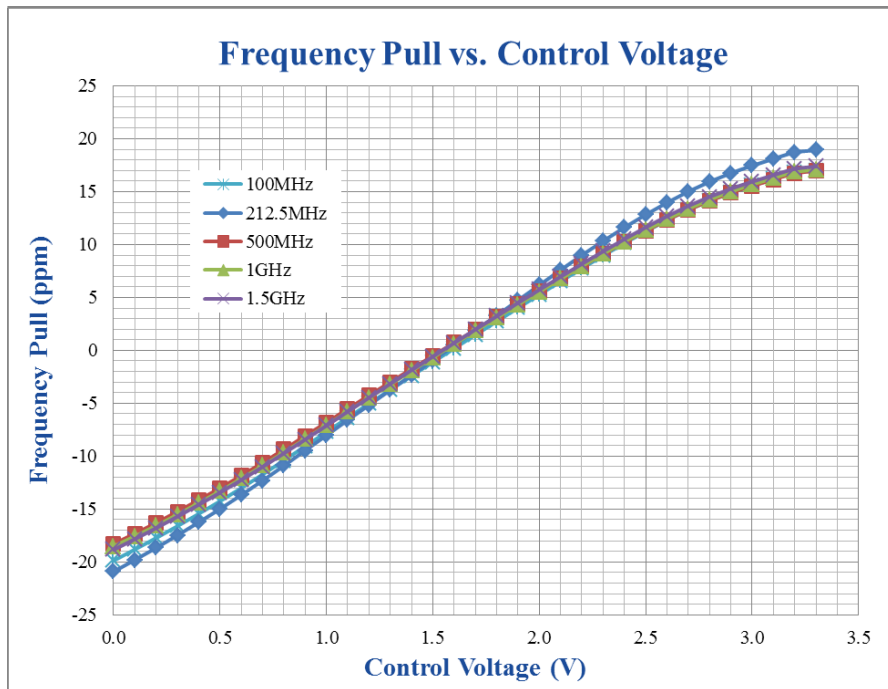

Configurable High Performance SMD TCXO/VCTCXO

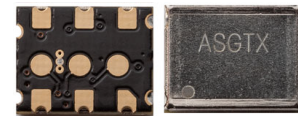

9.0 x 7.0 x 2.24 mm

ASGTX

RoHS/RoHS II Compliant

OUTLINE DIMENSION:

LVC MOS output

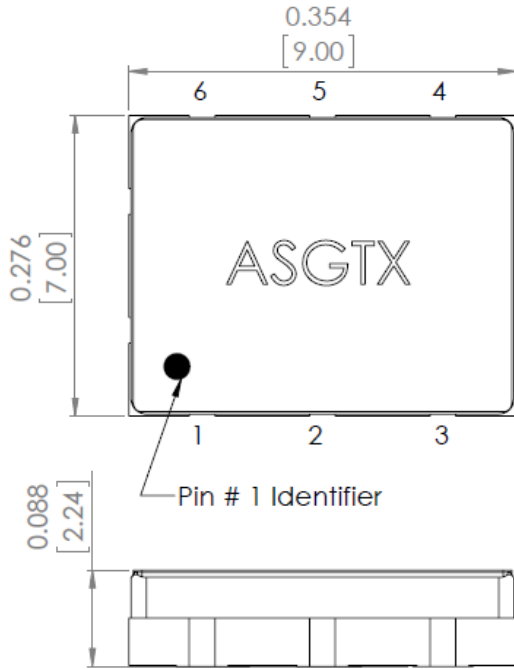

| Pin # | Pin Description | |
|-------|------------------------|-------------------|
| | TCXO | VCTCXO |
| 1 | N/C ⁽¹⁾ | |
| 2 | By-Pass ⁽²⁾ | Vc ⁽³⁾ |
| 3 | GND | |
| 4 | RF Output | |
| 5 | N/C ⁽¹⁾ | |
| 6 | Vdd | |

N/C ⁽¹⁾ = Please leave these pins electrically floating on the end-PCB

By-Pass ⁽²⁾ = In TCXO configuration, it is recommended that a 1,000pF COG by-pass capacitor is connected between Pin#2 and GND

Vc ⁽³⁾ = Please connect external voltage to pull the oscillator frequency

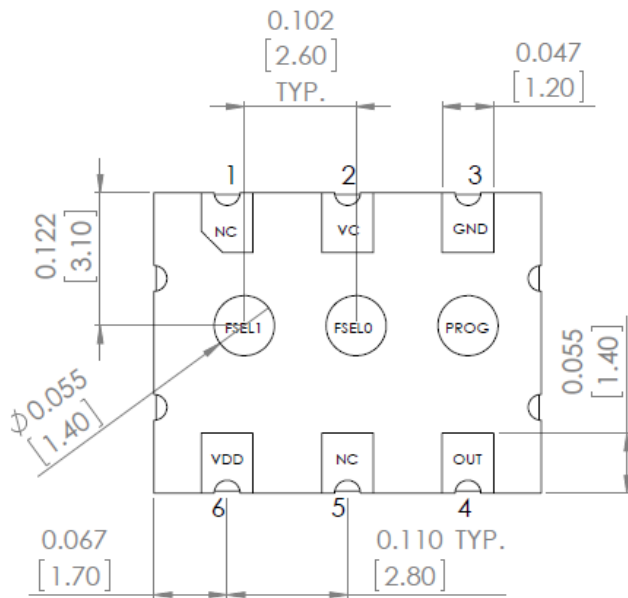

Recommended Land Pattern

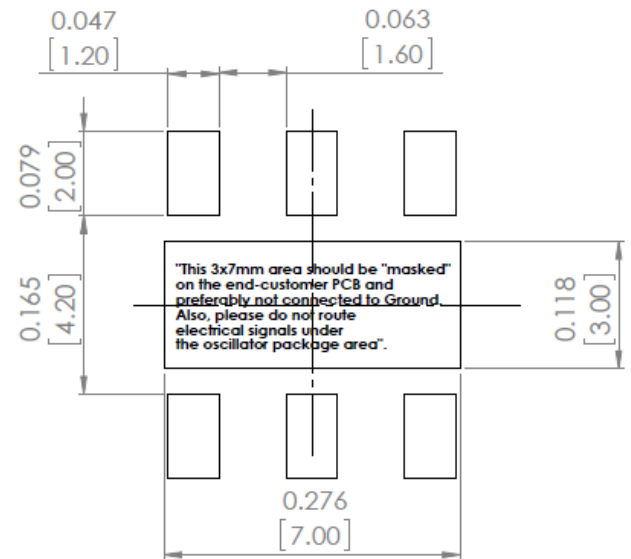

Dimensions: inches [mm]

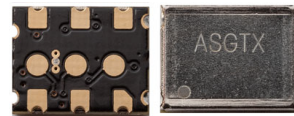

9.0 x 7.0 x 2.24 mm

ASGTX

RoHS/RoHS II Compliant

LVDS/LVPECL output

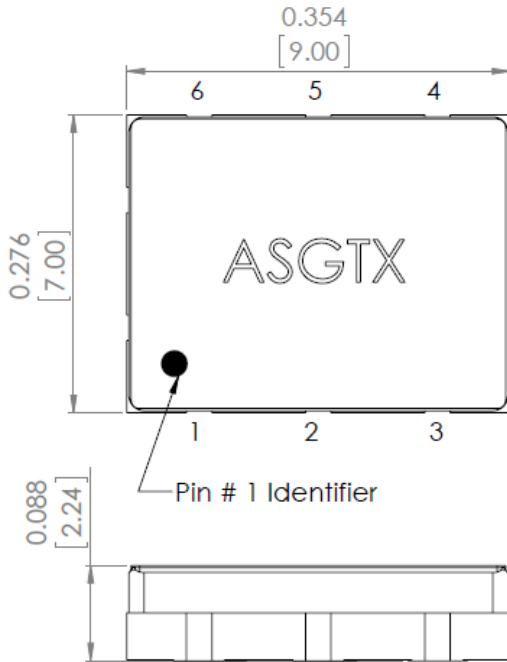

| Pin # | Pin Description | |
|-------|-------------------------|-------------------------------|
| | TCXO | VCTCXO |
| 1 | N/C ⁽¹⁾ | |
| 2 | By-Pass ⁽²⁾ | V _c ⁽³⁾ |
| 3 | GND | |
| 4 | RF Output | |
| 5 | Complimentary RF Output | |
| 6 | V _{dd} | |

N/C ⁽¹⁾ = Please leave this pin electrically floating on the end-PCB

By-Pass ⁽²⁾ = In TCXO configuration, it is recommended that a 1,000pF COG by-pass capacitor is connected between Pin#2 and GND

V_c ⁽³⁾ = Please connect external voltage to pull the oscillator frequency

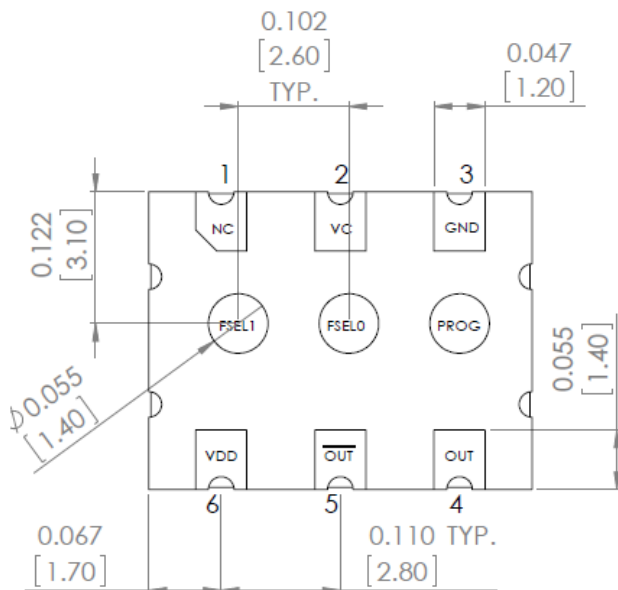

Recommended Land Pattern

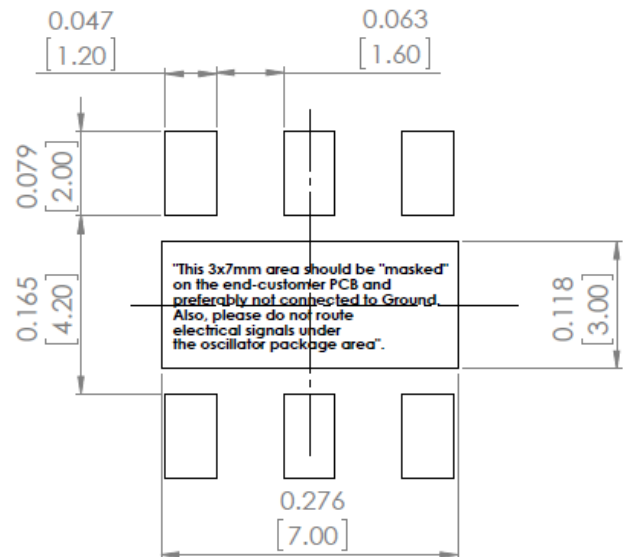

Dimensions: inches [mm]

Configurable High Performance SMD TCXO/VCTCXO

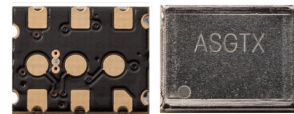

9.0 x 7.0 x 2.24 mm

ASGTX

RoHS/RoHS II Compliant

REFLOW PROFILE:

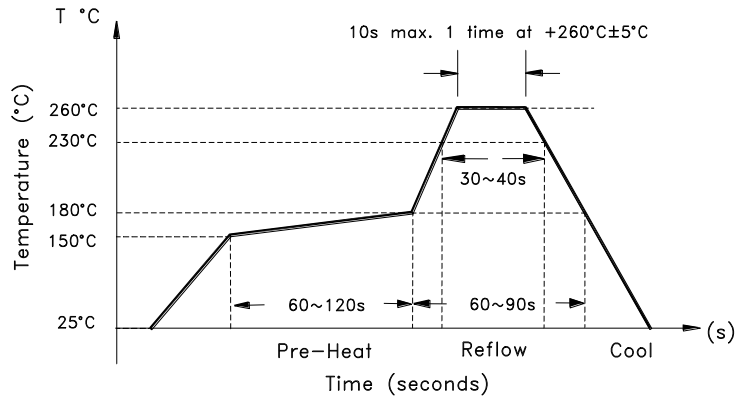

TAPE & REEL:

Packaging: 1000pcs/reel

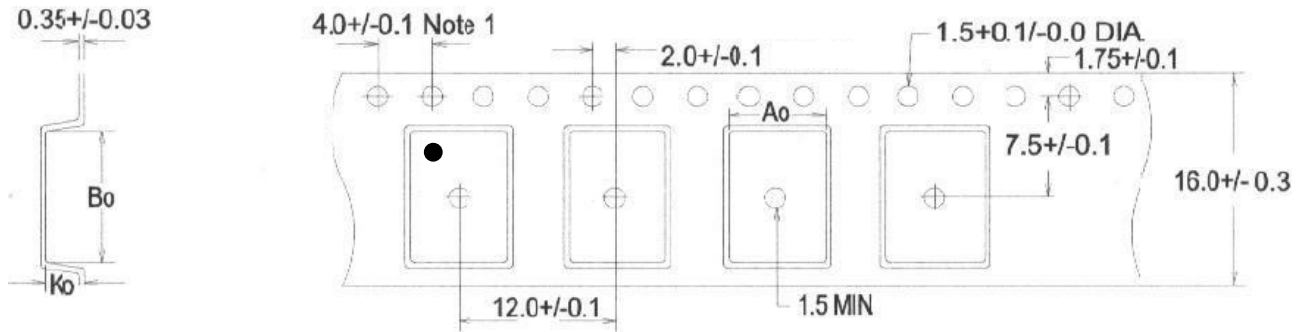

| A0 | B0 | K0 |
|----------|----------|----------|
| 7.10±0.1 | 9.60±0.1 | 3.00±0.1 |

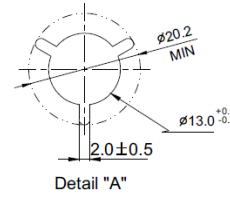
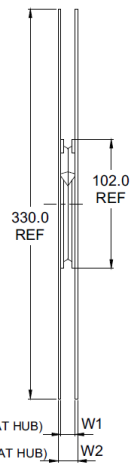
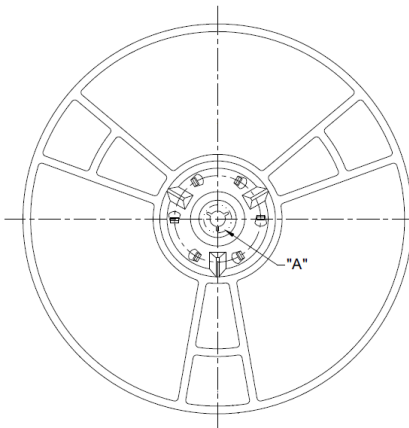

| W1 | W2 |
|---------------|-----------|
| 16.8±0.6/-0.4 | 22.2 max. |

Dimensions: mm

ATTENTION: Abracon Corporation's products are COTS – Commercial-Off-The-Shelf products; suitable for Commercial, Industrial and, where designated, Automotive Applications. Abracon's products are not specifically designed for Military, Aviation, Aerospace, Life-dependant Medical applications or any application requiring high reliability where component failure could result in loss of life and/or property. For applications requiring high reliability and/or presenting an extreme operating environment, written consent and authorization from Abracon Corporation is required. Please contact Abracon Corporation for more information.

ABRACON IS
ISO9001:2008
CERTIFIED



2 Faraday, Suit#B, Irvine, California 92618 Revised: 10.16.14

tel:949-546-8000 | fax:949-546-8001

Visit www.abracon.com for Terms & Conditions of Sale

X-ON Electronics

Largest Supplier of Electrical and Electronic Components

Click to view similar products for [TCVCXO Oscillators](#) category:

Click to view products by [ABRACON](#) manufacturer:

Other Similar products are found below :

[FOX923CH-19.20M](#) [SIT5000ACC8E-33VQ-19.200000X](#) [KT7050A10000KAW33TAD](#) [LFTVXO009900BULK](#) [LFTVXO076348CUTT](#)
[LFTVXO076344CUTT](#) [KT2016K27600ZAW18TCS](#) [LFTVXO076346CUTT](#) [LFTVXO076343CUTT](#) [LFTVXO072344CUTT](#)
[LFTVXO076349CUTT](#) [KT1612A26000ACW28TAN](#) [LFTVXO009907BULK](#) [AST3TQ53-V-20.000MHz-5-C](#) [ASVTX-12-A-16.369MHZ-I15-T](#) [ASVTX-13-A-19.200MHZ-D15-T](#) [ASVTX-13-A-26.000MHZ-D15-T](#) [LFTVXO009917BULK](#) [LFTVXO009919Bulk](#)
[LFTVXO009920BULK](#) [LFTVXO063787BULK](#) [LFTVXO070167Cutt](#) [LFTVXO070168Cutt](#) [LFTVXO070186Cutt](#) [LFTVXO009915BULK](#)
[TCD4029-26.0M](#) [THD3004-16.384M](#) [LFTVXO009900](#) [LFTVXO009901BULK](#) [ASVTX-09-19.440MHZ-T](#) [FOX801BELF-100](#)
[LFTVXO009919](#) [LFTVXO009915](#) [LFTVXO009917](#) [LFTVXO063705](#)