

Molding Type Power Inductor

ASPI-0530LR



RoHS
Compliant



5.6 x 5.2 x 3.0 mm

FEATURES:

- High saturation current.
- Low loss due to low DC resistance.
- Frequency application up to 3MHz.
- Low profile with max thickness 3.0mm.
- 100% lead free and metted RoHS standard.
- Suitable for reflow soldering.
- High reliable SMD package

APPLICATIONS:

- DC/DC converters in Notebook, Netbook, desktop and server
- Low profile, high current power supplies.

STANDARD SPECIFICATIONS

Abrakon P/N:	ASPI-0530LR Series
Operating Temperature & Humidity:	-55°C to +125°C (Including self generated heat)
Storage Temperature & Humidity:	+25°C to +35°C, 45% to 85% RH

Part Number	Inductance	Tolerance	DCR Typ	DCR Max	Saturation Current	Temperature Rise Current
Units	μH	%	mΩ	mΩ	A	A
Symbol	L	M			Isat	Irms
ASPI-0530LR-1R5	1.5	M	18.5	20.0	7.0	8.0
ASPI-0530LR-2R2	2.2	M	24.0	26.0	5.5	7.0
ASPI-0530LR-3R3	3.3	M	32.0	36.0	5.0	6.5
ASPI-0530LR-4R7	4.7	M	54.0	60.0	4.5	4.5
ASPI-0530LR-5R6	5.6	M	55.0	65.0	4.0	4.5

Test Conditions

Inductance is measured in HP-4284A Precision LCR Meter.

RDC is measured in HP-4338B milli ohm meter.(or equivalent).

Isat: Based on inductance change ($\Delta L/L_o : \leq -20\%$)

Irms: Based on temperature rise ($\Delta T : 40^\circ\text{C TYP.}$)

ELECTRICAL CHARACTERISTIC CURVES

ASPI-0530LR-1R5

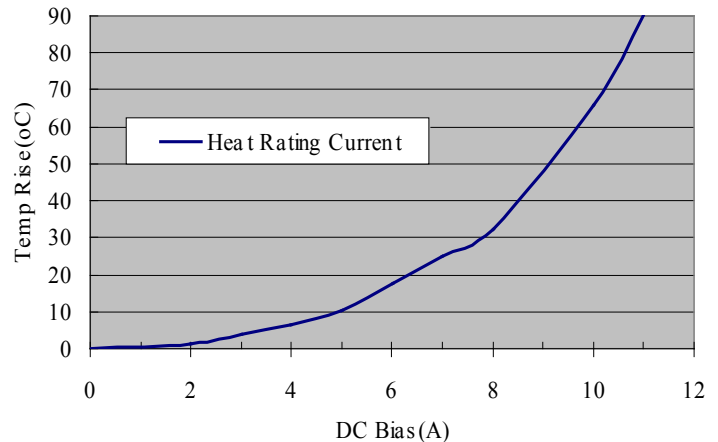
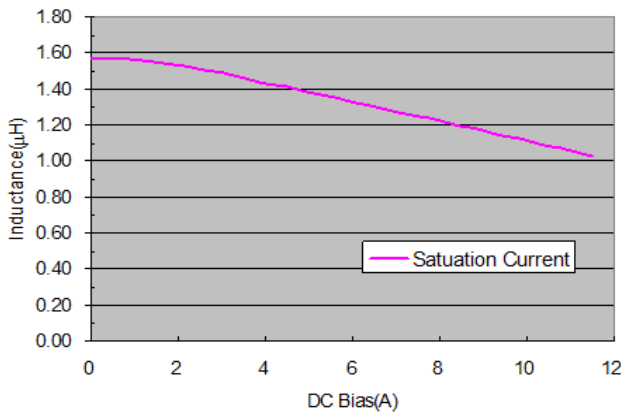

Molding Type Power Inductor

ASPI-0530LR



RoHS
Compliant



5.6 x 5.2 x 3.0 mm

ELECTRICAL CHARACTERISTIC CURVES

ASPI-0530LR-2R2

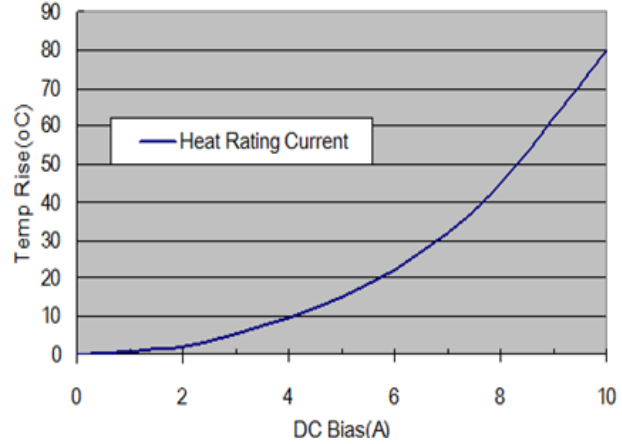
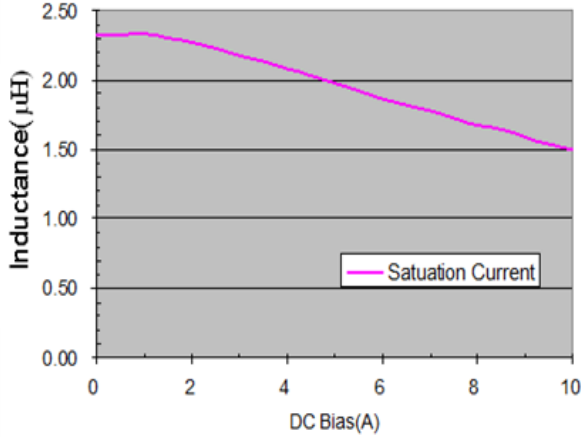

ASPI-0530LR-3R3

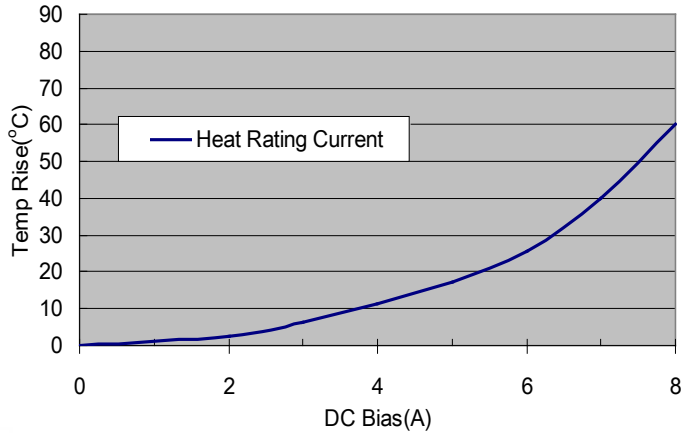
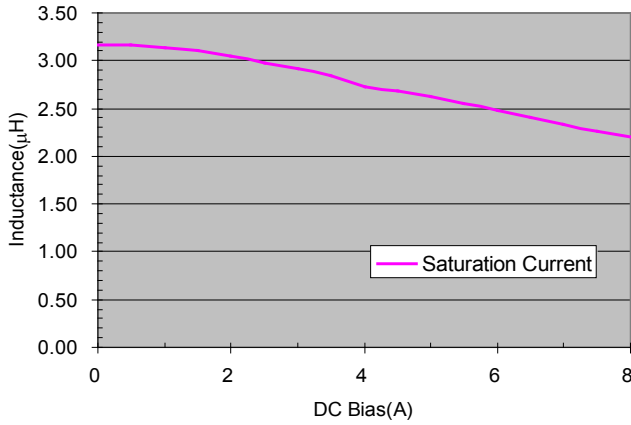

ASPI-0530LR-4R7

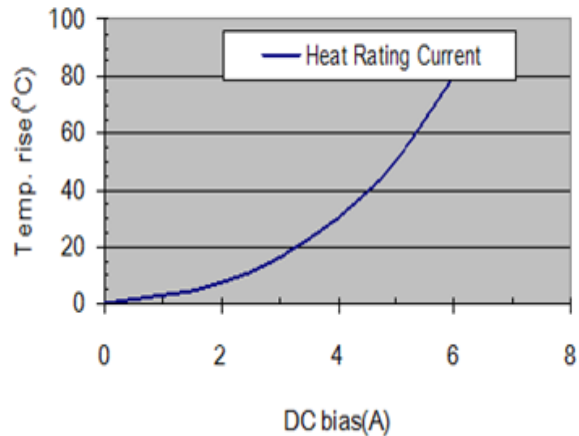
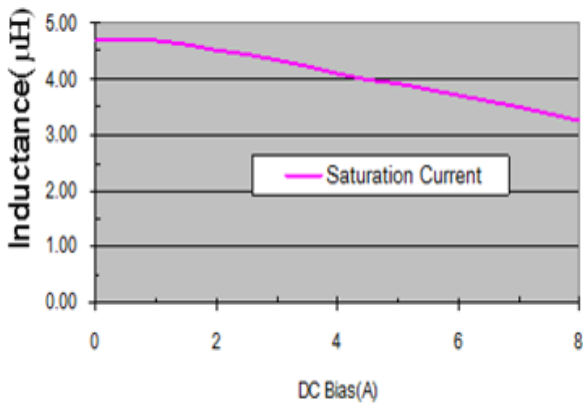

Molding Type Power Inductor

ASPI-0530LR



RoHS
Compliant



5.6 x 5.2 x 3.0 mm

ELECTRICAL CHARACTERISTIC CURVES

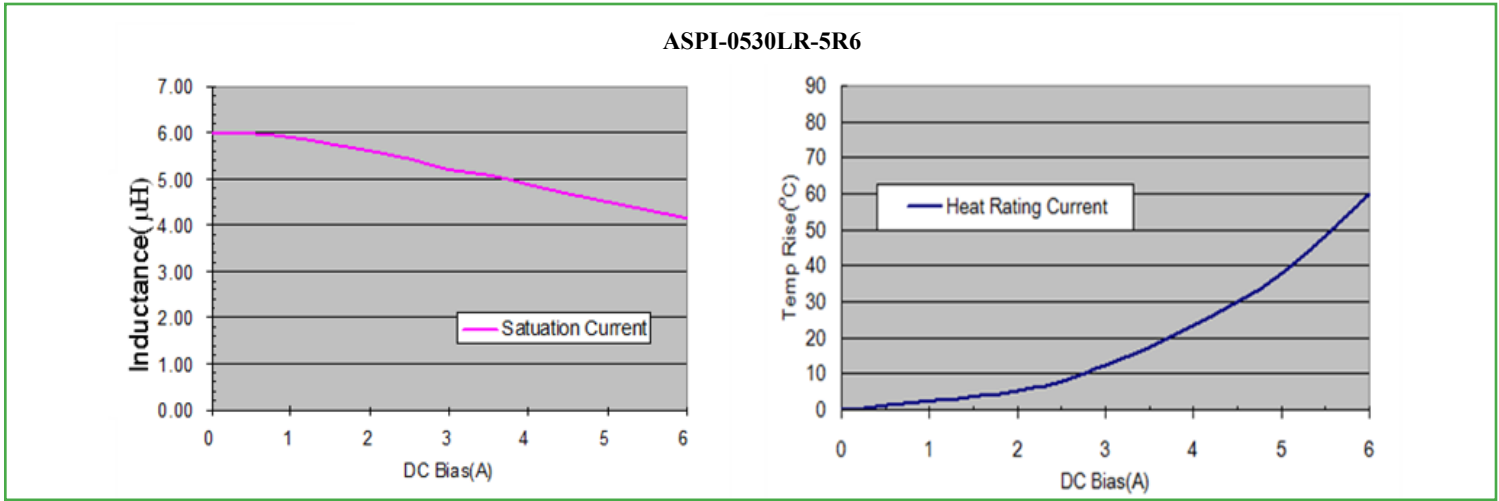

PART NUMBER IDENTIFICATION

ASPI-0530LR- -

Inductance Code	Tolerance	Packaging
Please refer to the Electrical Spec Table	M: ±20%	T2: Tape and Reel (2kpcs / reel)

OUTLINE DRAWING:

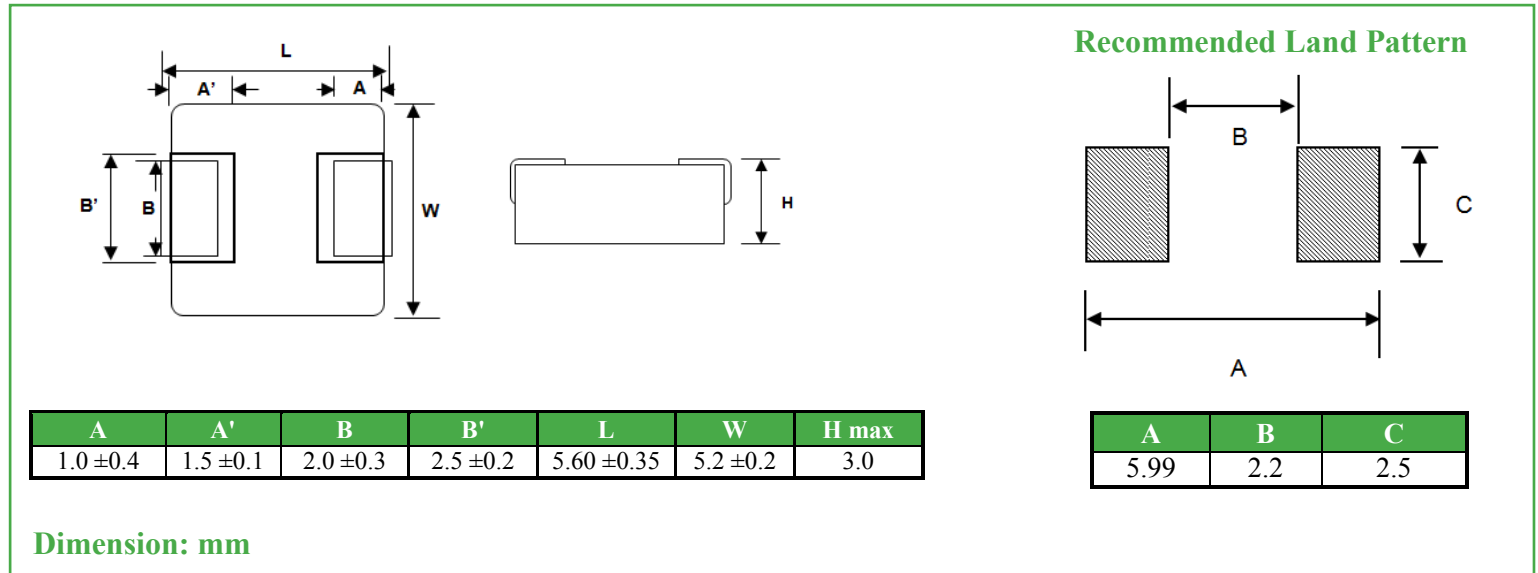

Molding Type Power Inductor

ASPI-0530LR



RoHS
Compliant



5.6 x 5.2 x 3.0 mm

TAPE & REEL:

T2: 2,000pcs / reel

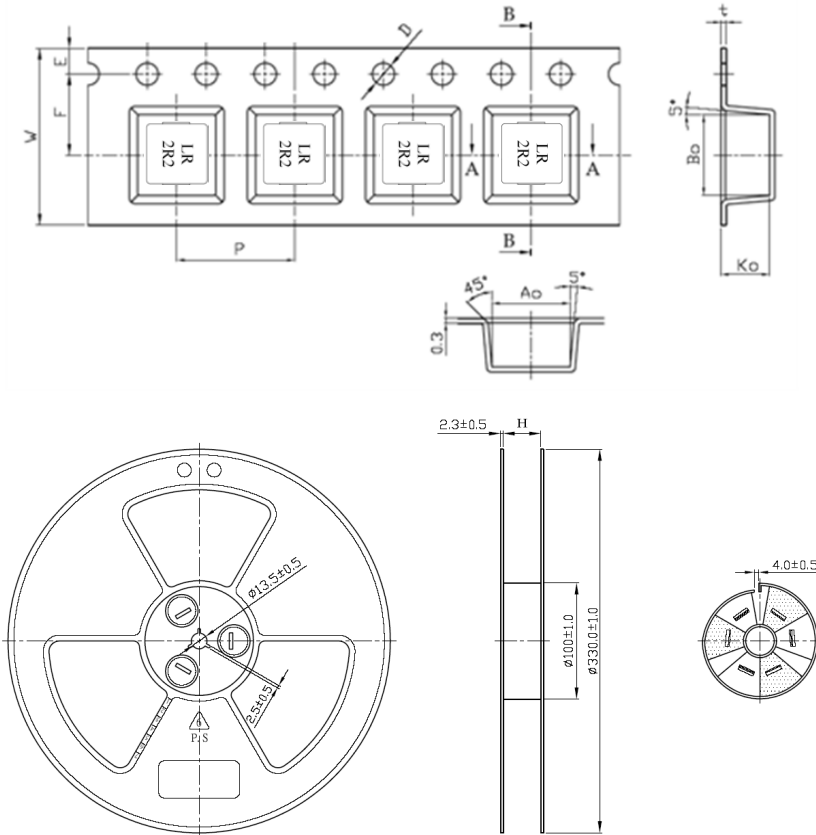

A0	5.3
B0	5.5
K0	3.3
P	8.0
t	0.4
W	12
E	1.75
F	5.5
D	1.5

Dimension: mm

REFLOW PROFILE:

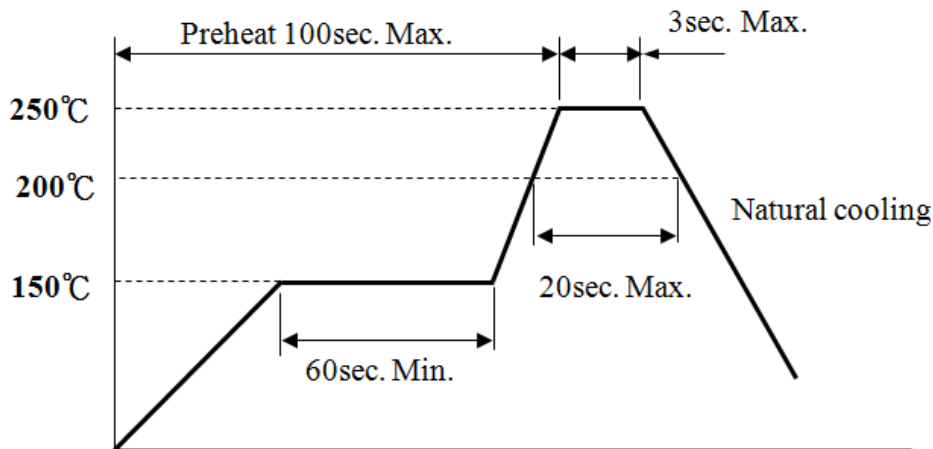

ATTENTION: Abracon Corporation's products are COTS – Commercial-Off-The-Shelf products; suitable for Commercial, Industrial and, where designated, Automotive Applications. Abracon's products are not specifically designed for Military, Aviation, Aerospace, Life-dependant Medical applications or any application requiring high reliability where component failure could result in loss of life and/or property. For applications requiring high reliability and/or presenting an extreme operating environment, written consent and authorization from Abracon Corporation is required. Please contact Abracon Corporation for more information.

ABRACON IS
ISO 9001:2008
CERTIFIED



Visit www.abracon.com for Terms & Conditions of Sale

Revised: 11.13.11

30332 Esperanza, Rancho Santa Margarita, California 92688
tel 949-546-8000 | fax 949-546-8001 | www.abracon.com

X-ON Electronics

Largest Supplier of Electrical and Electronic Components

Click to view similar products for [Fixed Inductors](#) category:

Click to view products by [ABRACON](#) manufacturer:

Other Similar products are found below :

[CR43NP-680KC](#) [CR54NP-820KC](#) [CR54NP-8R5MC](#) [CTX32CT-100](#) [70F224AI](#) [MGDQ4-00004-P](#) [MHL1ECTTP18NJ](#) [MHL1JCTTD12NJ](#)
[PE-51506NL](#) [PE-53601NL](#) [PE-53602NL](#) [PE-53630NL](#) [PE-53824SNLT](#) [PE-62892NL](#) [PE-92100NL](#) [PG0434.801NLT](#) [PG0936.113NLT](#)
[9310-16](#) [PM06-2N7](#) [PM06-39NJ](#) [A01TK](#) [1206CS-471XJ](#) [HC2-2R2TR](#) [HC2LP-R47-R](#) [HC3-2R2-R](#) [HCF1305-3R3-R](#) [1206CS-151XG](#)
[RCH664NP-140L](#) [RCH664NP-4R7M](#) [RCH8011NP-221L](#) [RCP1317NP-332L](#) [RCP1317NP-391L](#) [RCR1010NP-470M](#) [RCR110DNP-331L](#)
[DH2280-4R7M](#) [DS1608C-106](#) [ASPI-4020HI-R10M-T](#) [B10TJ](#) [B82477P4333M](#) [B82498B3101J000](#) [B82498B3680J000](#) [ELJ-RE27NJF2](#)
[1812CS-153XJ](#) [1812CS-183XJ](#) [1812CS-223XJ](#) [1812LS-104XJ](#) [1812LS-105XJ](#) [1812LS-124XJ](#) [1812LS-154XJ](#) [1812LS-223XJ](#)