

SMD POWER INDUCTOR



15.24 x 18.54 x 7.11 mm

ASPI-1306T

 RoHS Compliant

FEATURES:

- Low profile, compact size
- Large Terminal surface for good PCB bonding
- Low DCR, High Energy storage, suitable for large currents
- Ideal for a variety of DC-DC converter inductor applications

APPLICATIONS:

- Desktop, Laptop, servers
- Network hubs, bridges, routers
- Portable communication equipment
- OA equipment
- LCD, DVD, modem, set-top box
- DC/DC converters

ELECTRICAL SPECIFICATIONS:

Abracon P/N:	ASPI-1306T
Operating Temperature:	-40°C to +85°C
Storage Temperature:	: -40°C to +85°C

Key Electrical Specifications at 25°C

PART NUMBER	INDUCTANCE (uH)	Tolerance	SRF (MHz) max	RDC (Ω) max	Isat (A) max	Irms (A) max
ASPI-1306T-1R0	1	M	80	0.009	20	8.6
ASPI-1306T-2R2	2.2	M	80	0.014	16	7.1
ASPI-1306T-3R3	3.3	M	60	0.015	14	6.2
ASPI-1306T-4R7	4.7	M	60	0.018	13	6
ASPI-1306T-5R6	5.6	M	40	0.02	12	5.3
ASPI-1306T-8R2	8.2	M	30	0.029	10	4.8
ASPI-1306T-100	10	M	30	0.031	10	4.3
ASPI-1306T-150	15	M	22	0.036	8	4
ASPI-1306T-220	22	M	20	0.047	7	3.5
ASPI-1306T-330	33	M	15	0.066	5.5	3
ASPI-1306T-470	47	M	9	0.086	4.5	2.6
ASPI-1306T-680	68	M	8	0.13	3.5	2.3
ASPI-1306T-750	75	M	8	0.152	3	2.3
ASPI-1306T-101	100	M	7	0.19	3	1.8
ASPI-1306T-151	150	M	6	0.25	2.6	1.5
ASPI-1306T-221	220	M	5	0.38	2.4	1.2
ASPI-1306T-331	330	M	4	0.56	1.9	1
ASPI-1306T-471	470	M	3	0.85	1.4	0.82
ASPI-1306T-681	680	M	2.5	1.10	1.2	0.72
ASPI-1306T-102	1000	M	2	1.80	1	0.56

Test Conditions

Inductance: 100kHz, 0.1V

Isat: $\Delta L/L$ (initial) $\leq 10\%$

Irms: $\Delta T \leq 40^\circ\text{C}$

ABRACON IS
ISO 9001:2008
CERTIFIED



ABRACON
CORPORATION

Visit www.abracon.com for Terms & Conditions of Sale **Revised: 06.07.13**
30332 Esperanza, Rancho Santa Margarita, California 92688
tel 949-546-8000 | fax 949-546-8001 | www.abracon.com

SMD POWER INDUCTOR



15.24 x 18.54 x 7.11 mm

ASPI-1306T

RoHS Compliant

OPTIONS AND PART IDENTIFICATION

ASPI-1306T - -

Inductance Code
Please refer to the table above

Tolerance %
M: $\pm 20\%$

Packaging
T: Tape and Reel
(500pcs / reel)

ELECTRICAL CHARACTERISTICS CURVES

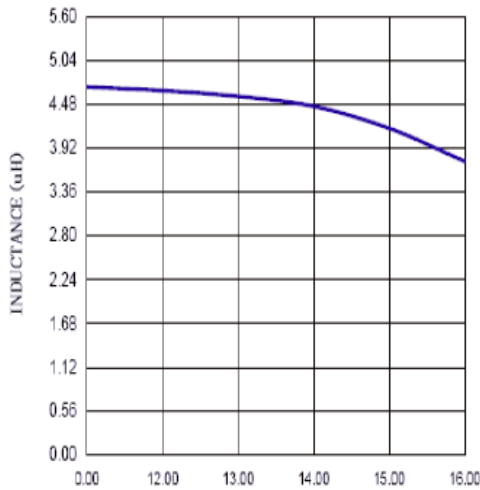

CURRENT (A)
ASPI-1306T-4R7M

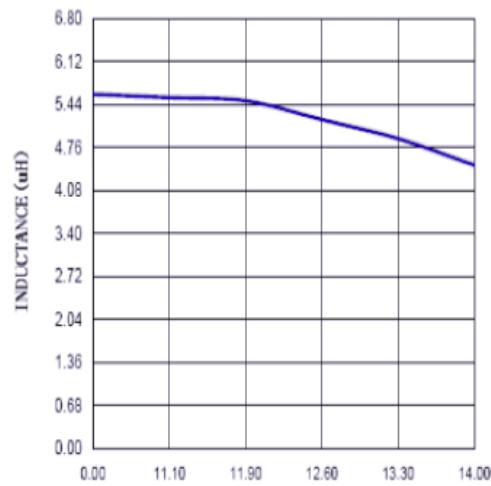

CURRENT (A)
ASPI-1306T-5R6M

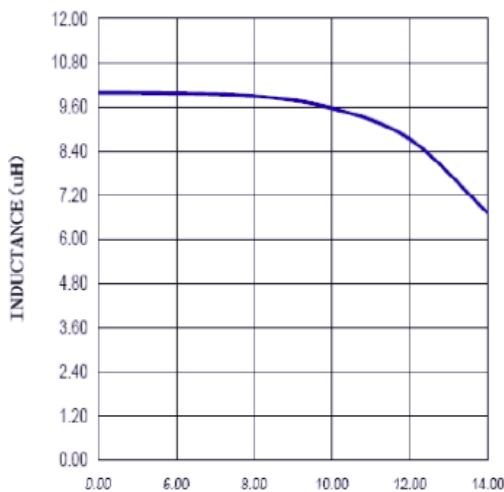

CURRENT (A)
ASPI-1306T-100M

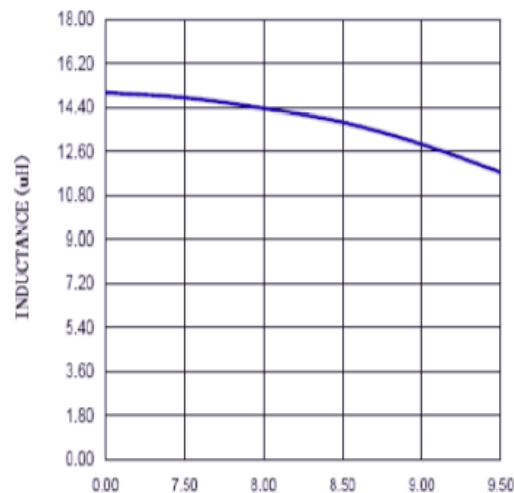

CURRENT (A)
ASPI-1306T-150M

SMD POWER INDUCTOR



15.24 x 18.54 x 7.11 mm

ASPI-1306T

RoHS Compliant

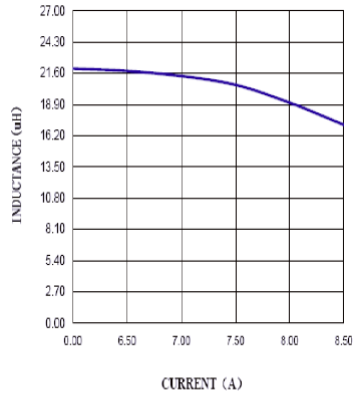

ASPI-1306T-220M

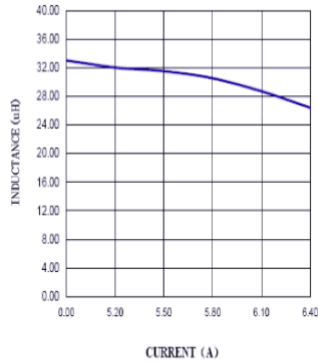

ASPI-1306T-330M

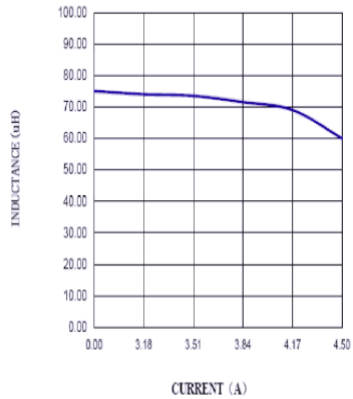

ASPI-1306T-750M

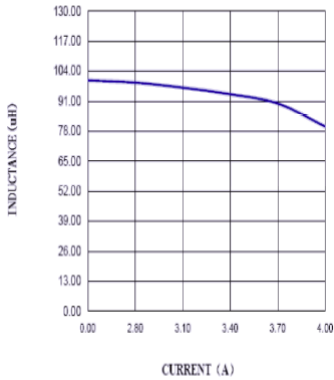

ASPI-1306T-101M

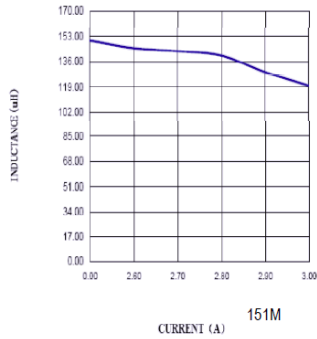

ASPI-1306T-151M

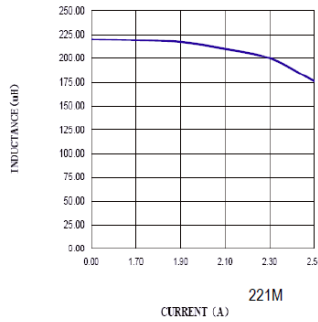

ASPI-1306T-221M

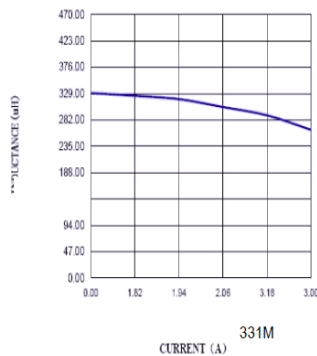

ASPI-1306T-331M

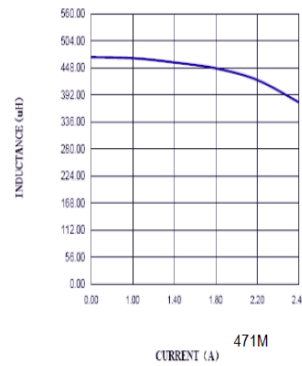

ASPI-1306T-471M

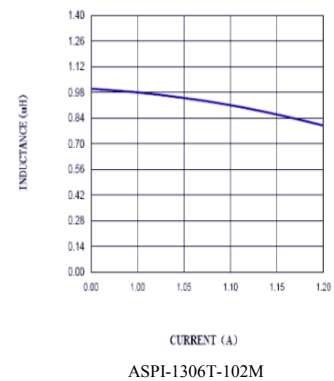

ASPI-1306T-102M

ABRACON IS
ISO 9001:2008
CERTIFIED



ABRACON
CORPORATION

Visit www.abracon.com for Terms & Conditions of Sale **Revised: 06.07.13**
30332 Esperanza, Rancho Santa Margarita, California 92688
tel 949-546-8000 | fax 949-546-8001 | www.abracon.com

SMD POWER INDUCTOR



15.24 x 18.54 x 7.11 mm

ASPI-1306T

RoHS Compliant

OUTLINE DIMENSION:

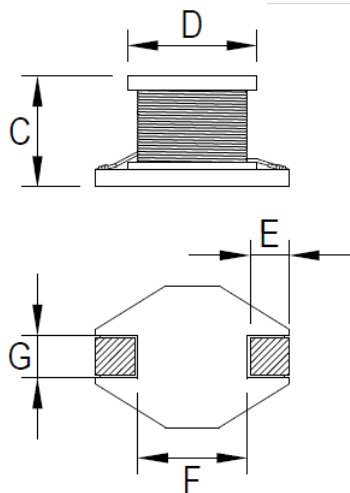
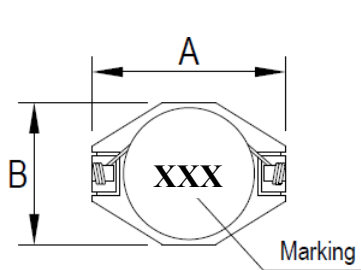

Recommended Land Pattern

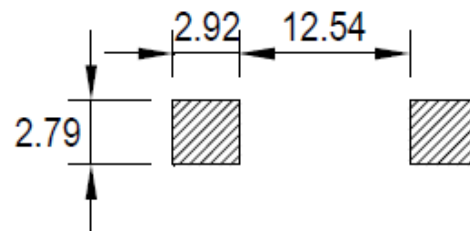

	DIM.	TOL.
A	18.54	Max.
B	15.24	Max.
C	7.11	Max.
D	12.70	±0.3
E	2.54	±0.3
F	12.70	±0.3
G	2.54	±0.3

Dimension: mm

REFLOW PROFILE:

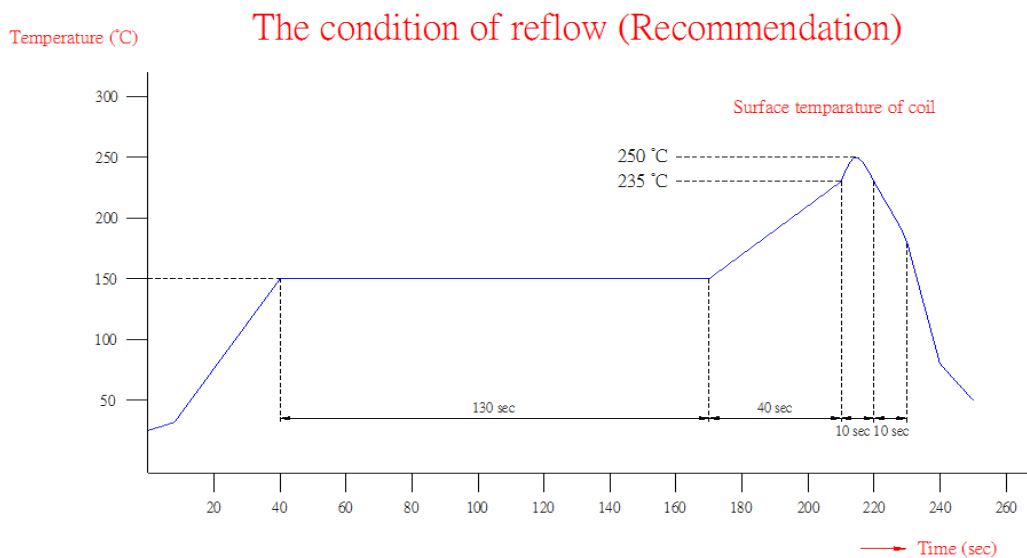

SMD POWER INDUCTOR



15.24 x 18.54 x 7.11 mm

ASPI-1306T

RoHS Compliant

TAPE & REEL

T: 500pcs / reel

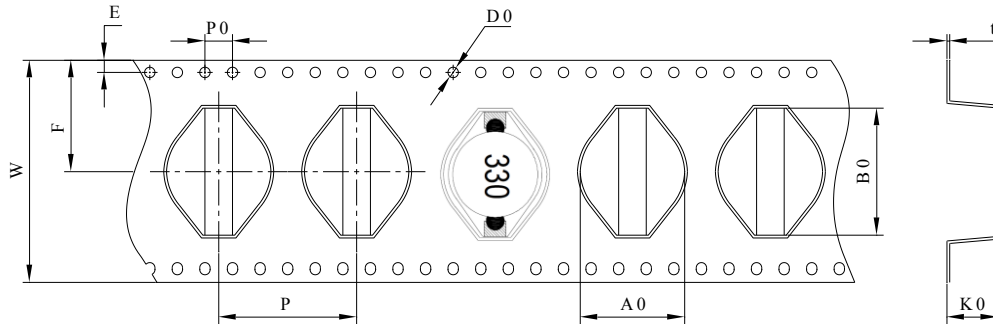

W	E	F	P	A0	B0	D0	P0	K0	t
32±0.3	1.75±0.1	16.25±0.1	20.0±0.1	15.5±0.1	19.5±0.1	1.5±0.1	4.0±0.1	7.1±0.1	0.3±0.05

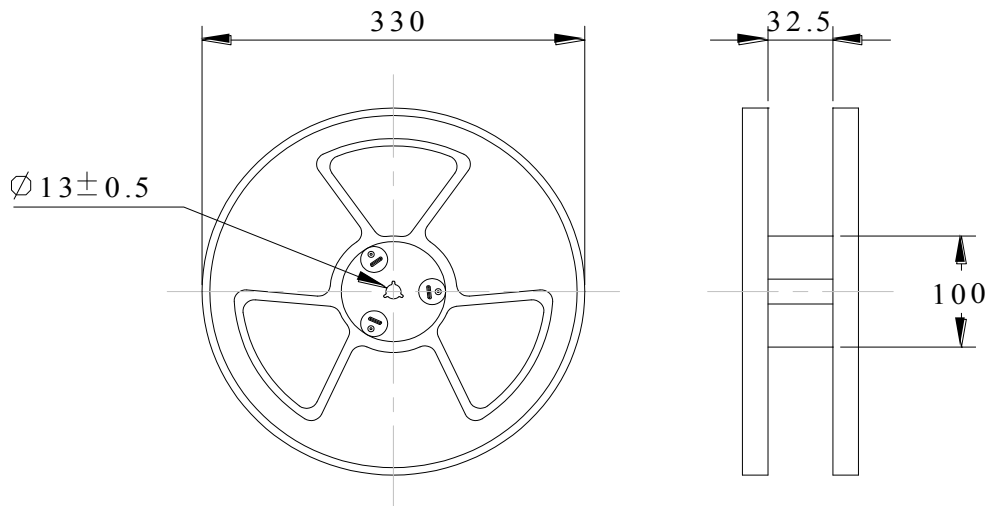

Dimension: mm

ATTENTION: Abracon Corporation's products are COTS – Commercial-Off-The-Shelf products; suitable for Commercial, Industrial and, where designated, Automotive Applications. Abracon's products are not specifically designed for Military, Aviation, Aerospace, Life-dependant Medical applications or any application requiring high reliability where component failure could result in loss of life and/or property. For applications requiring high reliability and/or presenting an extreme operating environment, written consent and authorization from Abracon Corporation is required. Please contact Abracon Corporation for more information.

ABRACON IS
ISO 9001:2008
CERTIFIED



Visit www.abracon.com for Terms & Conditions of Sale **Revised: 06.07.13**
30332 Esperanza, Rancho Santa Margarita, California 92688
tel 949-546-8000 | fax 949-546-8001 | www.abracon.com

X-ON Electronics

Largest Supplier of Electrical and Electronic Components

Click to view similar products for [Fixed Inductors](#) category:

Click to view products by [Abracon](#) manufacturer:

Other Similar products are found below :

[CR32NP-100KC](#) [CR32NP-151KC](#) [CR32NP-180KC](#) [CR32NP-181KC](#) [CR32NP-1R5MC](#) [CR32NP-390KC](#) [CR32NP-3R9MC](#) [CR32NP-680KC](#) [CR32NP-820KC](#) [CR32NP-8R2MC](#) [CR43NP-390KC](#) [CR43NP-560KC](#) [CR43NP-680KC](#) [CR54NP-181KC](#) [CR54NP-470LC](#) [CR54NP-820KC](#) [CR54NP-8R5MC](#) [70F224AI](#) [MGDQ4-00004-P](#) [MHL1ECTTP18NJ](#) [MHQ1005P10NJ](#) [MHQ1005P1N0S](#) [MHQ1005P2N4S](#) [MHQ1005P3N6S](#) [MHQ1005P5N1S](#) [MHQ1005P8N2J](#) [PE-51506NL](#) [PE-53601NL](#) [PE-53602NL](#) [PE-53630NL](#) [PE-53824SNLT](#) [PE-92100NL](#) [PG0434.801NLT](#) [PG0936.113NLT](#) [9220-20](#) [9310-16](#) [PM06-2N7](#) [PM06-39NJ](#) [A01TK](#) [1206CS-471XJ](#) [HC2LP-R47-R](#) [HC2-R47-R](#) [HC3-2R2-R](#) [HCF1305-3R3-R](#) [1206CS-151XG](#) [RCH664NP-140L](#) [RCH664NP-4R7M](#) [RCH8011NP-221L](#) [RCP1317NP-332L](#) [RCP1317NP-391L](#)