

THIN FILM CHIP INDUCTORS

ATFC-0201

RoHS
Compliant

0.60 x 0.30 x 0.23mm

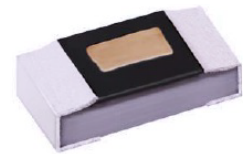

FEATURES:

- Photolithographic single layer ceramic chip
- High SRF, excellent Q, superior temperature stability
- Tight tolerance $\pm 0.1nH$ available
- Self resonant frequency controlled within 10%
- Stable inductance in high frequency circuit
- Highly stable design for critical needs

APPLICATIONS:

- Cell phones and GPS
- VCO, TCXO Circuit and RF Transceiver Module
- Wireless LAN, Bluetooth Module, Communication Appliances

STANDARD SPECIFICATIONS:

PARAMETERS

ABRACON P/N:	ATFC-0201
Operating temperature :	-25°C to +85°C
Storage temperature:	25 \pm 3°C; Humidity <80%RH in Tape & Reel.

Part Number ATFC-0201- Inductance Code	L(nH)	Tolerance (\pm %)	Q, Min @ 500MHz	SRF Min (GHz)	R _{DC} Max (Ω)	I _{DC} Max (mA)
ATFC-0201-0N1	0.1	B, C, S	8	9	0.20	400
ATFC-0201-0N2	0.2	B, C, S	8	9	0.20	400
ATFC-0201-0N3	0.3	B, C, S	8	9	0.20	400
ATFC-0201-0N4	0.4	B, C, S	8	9	0.25	350
ATFC-0201-0N5	0.5	B, C, S	8	9	0.25	350
ATFC-0201-0N6	0.6	B, C, S	8	9	0.25	350
ATFC-0201-0N7	0.7	B, C, S	8	9	0.30	300
ATFC-0201-0N8	0.8	B, C, S	8	9	0.30	300
ATFC-0201-0N9	0.9	B, C, S	8	9	0.30	300
ATFC-0201-1N0	1.0	B, C, S	8	9	0.30	300
ATFC-0201-1N1	1.1	B, C, S	8	9	0.35	300
ATFC-0201-1N2	1.2	B, C, S	8	9	0.35	300
ATFC-0201-1N3	1.3	B, C, S	8	9	0.45	250
ATFC-0201-1N4	1.4	B, C, S	8	9	0.45	250
ATFC-0201-1N5	1.5	B, C, S	8	9	0.45	250
ATFC-0201-1N6	1.6	B, C, S	8	9	0.55	200
ATFC-0201-1N7	1.7	B, C, S	8	9	0.55	200
ATFC-0201-1N8	1.8	B, C, S	8	9	0.55	200
ATFC-0201-1N9	1.9	B, C, S	8	9	0.55	200
ATFC-0201-2N0	2.0	B, C, S	8	8	0.70	200
ATFC-0201-2N1	2.1	B, C, S	8	8	0.70	200
ATFC-0201-2N2	2.2	B, C, S	8	8	0.70	200
ATFC-0201-2N3	2.3	B, C, S	8	8	0.80	150
ATFC-0201-2N4	2.4	B, C, S	8	8	0.80	150
ATFC-0201-2N5	2.5	B, C, S	8	8	0.80	150
ATFC-0201-2N6	2.6	B, C, S	8	8	0.80	150
ATFC-0201-2N7	2.7	B, C, S	8	8	0.80	150
ATFC-0201-2N8	2.8	B, C, S	8	6	1.00	150
ATFC-0201-2N9	2.9	B, C, S	8	6	1.00	150
ATFC-0201-3N0	3.0	B, C, S	8	6	1.00	150
ATFC-0201-3N1	3.1	B, C, S	8	6	1.00	150
ATFC-0201-3N2	3.2	B, C, S	8	6	1.00	150
ATFC-0201-3N3	3.3	B, C, S	8	6	1.00	150
ATFC-0201-3N4	3.4	B, C, S	8	6	1.20	150
ATFC-0201-3N5	3.5	B, C, S	8	6	1.20	150
ATFC-0201-3N6	3.6	B, C, S	8	6	1.20	150
ATFC-0201-3N7	3.7	B, C, S	8	6	1.20	150
ATFC-0201-3N8	3.8	B, C, S	8	6	1.20	150
ATFC-0201-3N9	3.9	B, C, S	8	6	1.20	150

ABRACON IS
ISO 9001 /2008
CERTIFIED



Visit www.abracon.com for Terms & Conditions of Sale
30332 Esperanza, Rancho Santa Margarita, California 92688
tel 949-546-8000 | fax 949-546-800 | www.abracon.com

Revised: 05.20.13
30332 Esperanza, Rancho Santa Margarita, California 92688
www.abracon.com

THIN FILM CHIP INDUCTORS

ATFC-0201

RoHS
Compliant

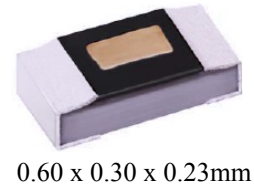

Key Electrical Specifications (Con'd)

Part Number AITFC-0201- Inductance Code	L(nH)	Tolerance (±%)	Q, Min @ 500MHz	SRF Min (GHz)	R _{DC} Max (Ω)	I _{DC} Max (mA)
ATFC-0201-4N0	4.0	B, C, S	8	6	1.20	150
ATFC-0201-4N4	4.4	B, C, S	8	6	1.30	140
ATFC-0201-4N7	4.7	B, C, S	8	6	1.40	130
ATFC-0201-4N9	4.9	B, C, S	8	6	1.60	130
ATFC-0201-5N6	5.6	G, J	8	4	1.80	130
ATFC-0201-6N1	6.1	G, J	8	4	2.00	120
ATFC-0201-6N8	6.8	G, J	8	4	2.30	110
ATFC-0201-7N4	7.4	G, J	8	4	2.80	110
ATFC-0201-8N2	8.2	G, J	8	3	3.00	110
ATFC-0201-9N1	9.1	G, J	8	3	3.25	100
ATFC-0201-9N2	9.2	G, J	8	3	3.25	100
ATFC-0201-10N	10	G, J	8	2	3.50	80

Test Conditions and Equipments

Inductance (L)

- Test equipment: Agilent4287A+Agilent16196C
- Test frequency: 500MHz

PART IDENTIFICATION:

ATFC- 0201- -

Inductance Code	Inductance Tolerance	Packaging
Please refer to the table above	J: ±5%	T: Tape and Reel (10kpcs / reel)
	G: ±2%	
	S: ±0.3nH	
	C: ±0.2nH	
	B: ±0.1nH	

OUTLINE DIMENSIONS:

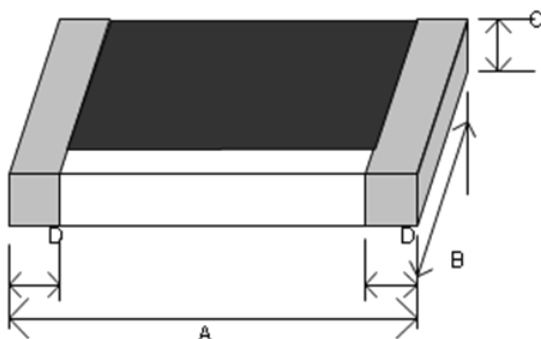

A	B	C	D
0.60±0.05	0.30±0.05	0.23±0.05	0.15±0.05

Recommended Land Pattern

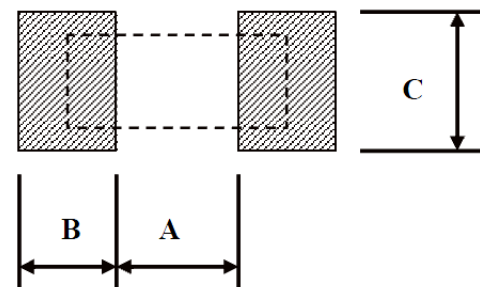

A	B	C
0.30	0.25	0.30±0.2

Dimension: mm

THIN FILM CHIP INDUCTORS

ATFC-0201

RoHS
Compliant

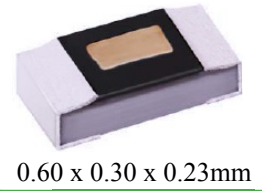

MATERIALS:

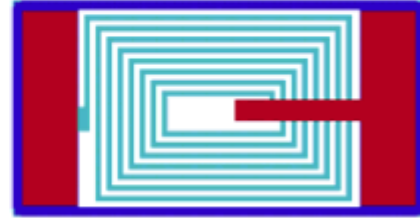
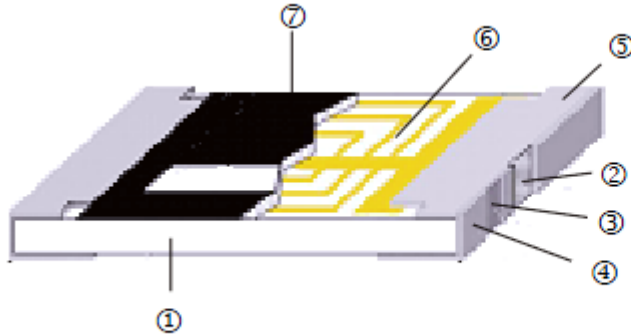

No.	Material
1	Alumina Substrate
2	Inner Electrode (Ni-Cr)
3	Barrier Layer (Ni)
4	External Electrode (Sn)
5	Edge Electrode
6	Cu Circuits
7	Overcoat

REFLOW PROFILE:

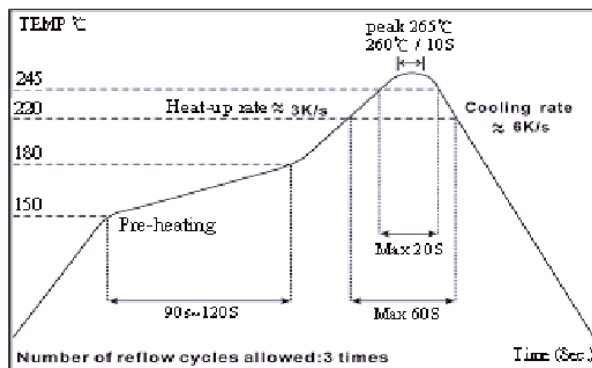

THIN FILM CHIP INDUCTORS

ATFC-0201

RoHS
Compliant

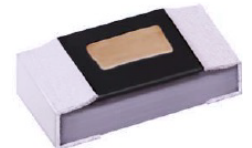

0.60 x 0.30 x 0.23mm

TAPE & REEL:

T= tape and reel (10,000pc/reel)

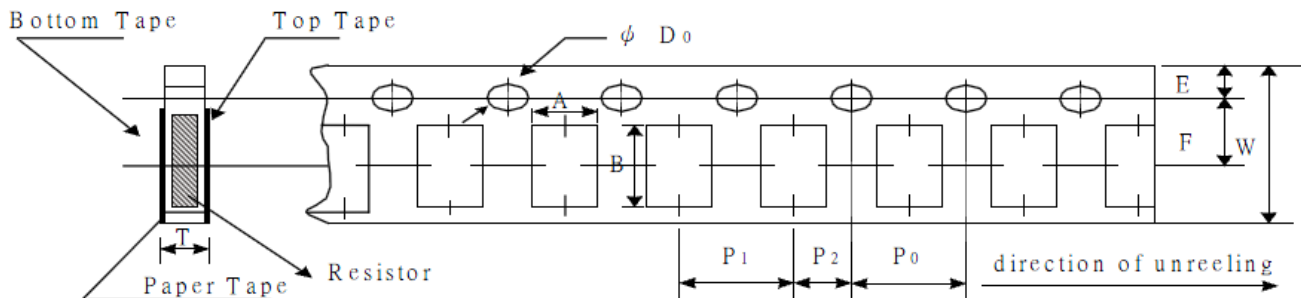

A	B	W	E	F	P0	P1	P2	ΦD0	T
0.40±0.05	0.70±0.05	8.00±0.10	1.75±0.05	3.50±0.05	4.00±0.10	2.00±0.05	2.00±0.05	1.55±0.03	0.42±0.02

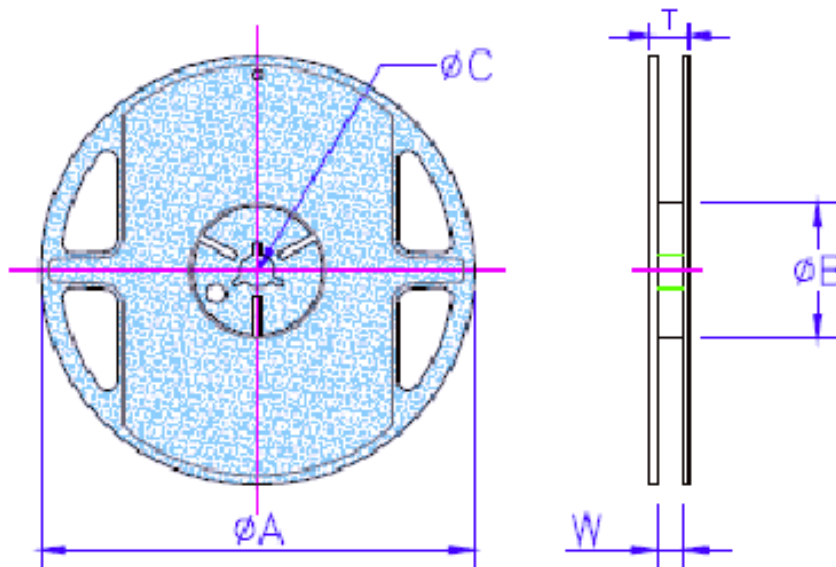

ΦA	ΦB	ΦC	W	T
178±1.0	60.0±1.0	13.5±0.70	9.5±1.0	11.5±1.0

Dimension: mm

ATTENTION: Abracon Corporation's products are COTS – Commercial-Off-The-Shelf products; suitable for Commercial, Industrial and, where designated, Automotive Applications. Abracon's products are not specifically designed for Military, Aviation, Aerospace, Life-dependant Medical applications or any application requiring high reliability where component failure could result in loss of life and/or property. For applications requiring high reliability and/or presenting an extreme operating environment, written consent and authorization from Abracon Corporation is required. Please contact Abracon Corporation for more information.

ABRACON IS
ISO 9001 /2008
CERTIFIED



Visit www.abracon.com for Terms & Conditions of Sale

Revised: 05.20.13

30332 Esperanza, Rancho Santa Margarita, California 92688
tel 949-546-8000 | fax 949-546-8001 | www.abracon.com

X-ON Electronics

Largest Supplier of Electrical and Electronic Components

Click to view similar products for [Fixed Inductors](#) category:

Click to view products by [ABRACON](#) manufacturer:

Other Similar products are found below :

[MLZ1608M6R8WTD25](#) [MLZ1608N6R8LT000](#) [MLZ1608N3R3LTD25](#) [MLZ1608N3R3LT000](#) [MLZ1608N150LT000](#)
[MLZ1608M150WTD25](#) [MLZ1608M3R3WTD25](#) [MLZ1608M3R3WT000](#) [MLZ1608M150WT000](#) [MLZ1608A1R5WT000](#)
[MLZ1608N1R5LT000](#) [B82432C1333K000](#) [PCMB053T-1R0MS](#) [PCMB053T-1R5MS](#) [PCMB104T-1R5MS](#) [CR32NP-100KC](#) [CR32NP-151KC](#) [CR32NP-180KC](#) [CR32NP-181KC](#) [CR32NP-1R5MC](#) [CR32NP-390KC](#) [CR32NP-3R9MC](#) [CR32NP-680KC](#) [CR32NP-820KC](#)
[CR32NP-8R2MC](#) [CR43NP-390KC](#) [CR43NP-560KC](#) [CR43NP-680KC](#) [CR54NP-181KC](#) [CR54NP-470LC](#) [CR54NP-820KC](#) [CR54NP-8R5MC](#)
[MGDQ4-00004-P](#) [MGDU1-00016-P](#) [MHL1ECTTP18NJ](#) [MHL1JCTTD12NJ](#) [PE-51506NL](#) [PE-53601NL](#) [PE-53630NL](#) [PE-53824SNLT](#) [PE-62892NL](#) [PE-92100NL](#) [PG0434.801NLT](#) [PG0936.113NLT](#) [PM06-2N7](#) [PM06-39NJ](#) [HC2LP-R47-R](#) [HC2-R47-R](#) [HC3-2R2-R](#) [HC8-1R2-R](#)