

CONTINUOUS VOLTAGE SMD TCXO

ATX-H11

Request Samples



Check Inventory



ESD Sensitive



3.2 x 2.5 x 1.2 mm
RoHS/RoHS II Compliant
MSL Level = 1

Features

- Both continuous & fixed Vdd options available
- Output waveform CMOS
- Hermetically seam-sealed ceramic package
- Low current consumption

Applications

- Cellular and cordless phones
- Standard oscillator for exact equipment
- Consumer electronics
- Industrial control & automation
- Mobile communication

Electrical Specifications ^[Note 1]

Parameters	Min.	Typ.	Max.	Units	Notes
Frequency Range	9.6		60	MHz	
Operating Temperature	-40		+105	°C	See Options (Table 1)
Storage Temperature	-40		+125	°C	
Frequency Stability $\Delta f/f_0$ vs:					
<i>Tolerance</i>	-1.0		+1.0	ppm	Reference to f_0 , at 25°C±2°C, Pre-reflow
<i>Tolerance</i>	-2.0		+2.0		Reference to f_0 , at 25°C ±2°C, 24 hours after reflow, two times
<i>Temperature</i>	-2.5		+2.5		See Options (Table 1)
<i>Supply Voltage Change</i>	-0.2		+0.2		Reference to f_0 , at 25°C ±2°C
<i>Load Change</i>	-0.2		+0.2		Vdd ± 5%
Aging	-1.0		+1.0		First year @+25°C±2°C
Supply Voltage (Vdd)	+3.135	+3.3	+3.465	V	Option E
	+2.85	+3.0	+3.15		Option A
	+2.66	+2.8	+2.94		Option B
	+2.375	+2.5	+2.625		Option C
	+1.71	+1.8	+1.89		Option D
	+1.68		+3.63		Option F
Supply Current (Idd)			4.8	mA	9.60MHz to 20.00MHz
			5.5		20.01MHz to 30.00MHz
			6.0		30.01MHz to 40.00MHz
			7.0		40.01MHz to 50.00MHz
			8.0		50.01MHz to 60.00MHz
Start-up Time			10	ms	
Rise and Fall Time (Tr/Tf) @10%Vdd-90%Vdd, 15pF load			5	ns	
Symmetry @ ½ Vdd	45	50	55	%	
Output Voltage	V _{OH}	90%Vdd		V	
	V _{OL}		10%Vdd		
Output Load			15	pF	CMOS
Output Waveform	CMOS				
Tri-state function ^[Note 2]	“1” (VIH≥0.7*Vdd) or Open: Oscillation; “0” (VIL<0.3*Vdd): No Oscillation/Hi Z			V	

Note 1: All measurements made at 25°C ±2°C, nominal Vdd, unless otherwise specified

Note 2: Do not leave pin 1 ($\overline{\text{INH}}$) floating. If pin 1 ($\overline{\text{INH}}$) is not utilized for toggling, it must be tied to Vdd (logic 1).



5101 Hidden Creek Ln Spicewood TX 78669
Phone: 512-371-6159 | Fax: 512-351-8858
For terms and conditions of sales, please visit:
www.abracon.com

REVISED: 05-26-23

ABRACON IS
ISO9001-2015
CERTIFIED

CONTINUOUS VOLTAGE SMD TCXO

ATX-H11

Request Samples



Check Inventory



ESD Sensitive



3.2 x 2.5 x 1.2 mm
RoHS/RoHS II Compliant
MSL Level = 1

Electrical Specifications continued

Parameters	Min.	Typ.	Max.	Units	Notes
Phase Noise (@ 10 MHz Carrier, @ 25°C ±2°C)					
@10Hz offset		-98	-94	dBc/Hz	Applicable to all standard available frequencies with Vdd = +1.8V, +2.5, +2.8, +3.0V, +3.3V
@100Hz offset		-122	-118		
@1kHz offset		-145	-141		
@10kHz offset		-152	-149		
@100kHz offset		-154	-151		
@1MHz offset		-154	-151		
@5MHz offset		-155	-152		
Phase Noise (@ 52 MHz Carrier, @ 25°C ±2°C)					
@10Hz offset		-83	-79	dBc/Hz	Applicable to all standard available frequencies with Vdd = +1.8V, +2.5, +2.8, +3.0V, +3.3V
@100Hz offset		-106	-102		
@1kHz offset		-127	-123		
@10kHz offset		-147	-144		
@100kHz offset		-154	-151		
@1MHz offset		-155	-152		
@10MHz offset		-155	-152		
@20MHz offset		-155	-152		

CONTINUOUS VOLTAGE SMD TCXO

ATX-H11

Request Samples 

Check Inventory 



ESD Sensitive



3.2 x 2.5 x 1.2 mm
RoHS/RoHS II Compliant
 MSL Level = 1

Part Identification

ATX-H11-- MHz--

Vdd (V)
A: 3.0V±5%
B: 2.8V±5%
C: 2.5V±5%
D: 1.8V±5%
E: 3.3V±5%
F: +1.68V ~ +3.63V

Frequency in MHz
Please specify the frequency in MHz. e.g. 26.000MHz

Packaging
Blank: Bulk
T: 1000pcs/reel
T3: 3000pcs/reel

Table 1: Frequency Stability vs Operating Temperature

OTR	±2.5ppm	±3.0ppm	±4.0ppm	±5.0ppm	±10.0ppm
0°C ~ +70°C	A25	A30	A40	A50	A100
-10°C ~ +60°C	B25	B30	B40	B50	B100
-20°C ~ +70°C	C25	C30	C40	C50	C100
-30°C ~ +75°C	D25	D30	D40	D50	D100
-30°C ~ +85°C	E25	E30	E40	E50	E100
-40°C ~ +85°C	F25	F30	F40	F50	F100
-40°C ~ +105°C	-	-	-	G50	G100

CONTINUOUS VOLTAGE SMD TCXO

ATX-H11

Request Samples



Check Inventory



ESD Sensitive



3.2 x 2.5 x 1.2 mm
RoHS/RoHS II Compliant
 MSL Level = 1

Mechanical Dimensions

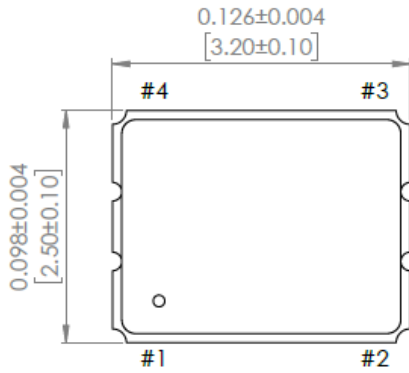

TOP VIEW

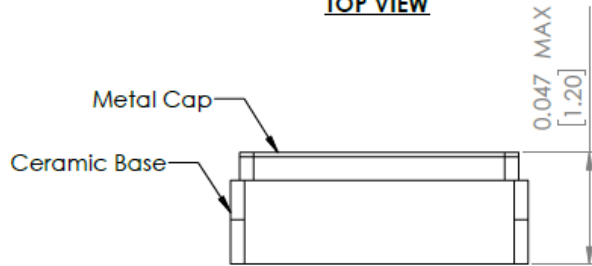

SIDE VIEW

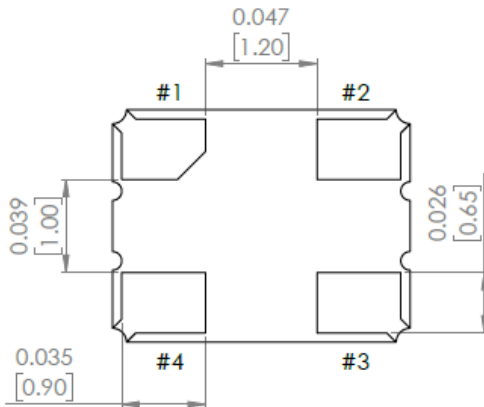

BOTTOM VIEW

Recommended Land Pattern

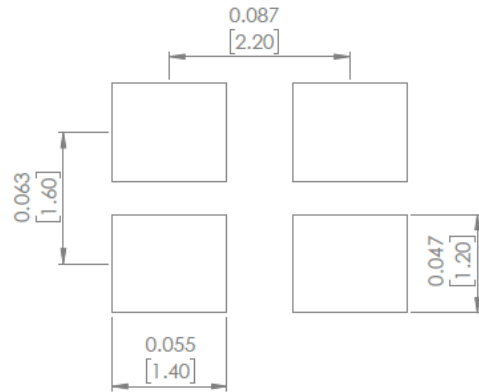

Pin #	Function
1	INH
2	GND
3	Output
4	Vdd

INH Function	
#1	#3 (Output)
Open	Active
"H" Level	Active
"L" Level	High Z (No Oscillation)

Note 3:

- Do not leave Pin 1 ($\overline{\text{INH}}$) floating
- If Pin 1 ($\overline{\text{INH}}$) is not utilized for toggling, it must be tied to Vdd (logic 1)

Note 4:

Recommended to use approximately 0.01µF bypass capacitor between PIN 2 and PIN 4

Dimensions: inches (mm)



5101 Hidden Creek Ln Spicewood TX 78669
 Phone: 512-371-6159 | Fax: 512-351-8858
 For terms and conditions of sales, please visit:
www.abracon.com

REVISED: 05-26-23

ABRACON IS
 ISO9001-2015
 CERTIFIED

CONTINUOUS VOLTAGE SMD TCXO

ATX-H11

Request Samples



Check Inventory



ESD Sensitive



3.2 x 2.5 x 1.2 mm
RoHS/RoHS II Compliant
MSL Level = 1

Reflow Profile [JDEC J-STD-020]

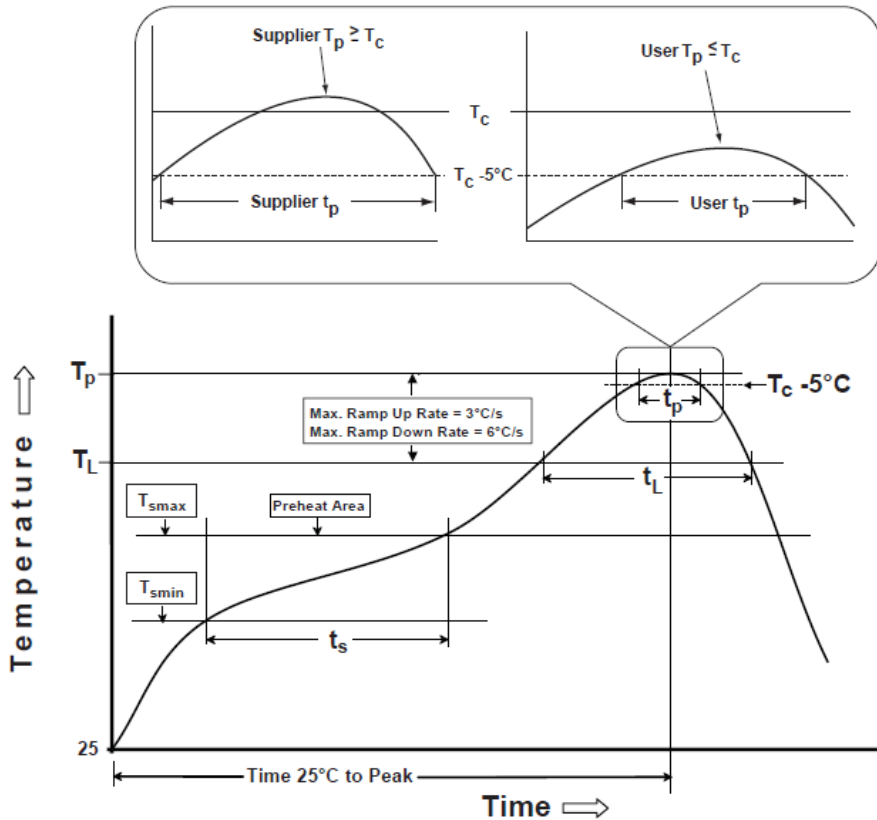

Table 1

SnPb Eutectic Process Classification Temperatures (T_c)		
Package Thickness	Volume mm^3 <350	Volume mm^3 \geq 350
<2.5 mm	235 °C	220 °C
\geq 2.5 mm	220 °C	220 °C

Table 2

Pb-Free Process Classification Temperatures (T_c)			
Package Thickness	Volume mm^3 <350	Volume mm^3 350-2000	Volume mm^3 >2000
<1.6 mm	260 °C	260 °C	260 °C
1.6 mm - 2.5 mm	260 °C	250 °C	245 °C
$>$ 2.5 mm	250 °C	245 °C	245 °C

Profile Feature	Sn-Pb Eutectic Assembly	Pb-Free Assembly
Preheat / soak		
Temperature minimum (T_{smin})	100°C	150°C
Temperature maximum (T_{smax})	150°C	200°C
Time (T_{smin} to T_{smax}) (t_s)	60 - 120 sec.	60 - 120 sec.
Average ramp-up rate (T_{smax} to T_p)	3°C/sec. max	3°C/sec. max
Liquidous temperature (T_L)	183°C	217°C
Time at liquidous (t_L)	60 - 150 sec.	60 - 150 sec.
Peak package body temperature (T_p)*	<i>see Table 1</i>	<i>see Table 2</i>
Time (t_p)** within 5°C of the specified classification temperature (T_c)	20 sec.	30 sec.
Ramp-down rate (T_p to T_{smax})	6°C/sec. max	6°C/sec. max
Time 25°C to peak temperature	6 min. max	8 min. max

*Tolerance for peak profile temperature (T_p) is defined as a supplier minimum and a user maximum.

**Tolerance for time at peak profile temperature (t_p) is defined as a supplier minimum and a user maximum.

CONTINUOUS VOLTAGE SMD TCXO

ATX-H11

Request Samples



Check Inventory



ESD Sensitive



3.2 x 2.5 x 1.2 mm
RoHS/RoHS II Compliant
 MSL Level = 1

Packaging

T: 1,000pcs/reel

T3: 3,000pcs/reel

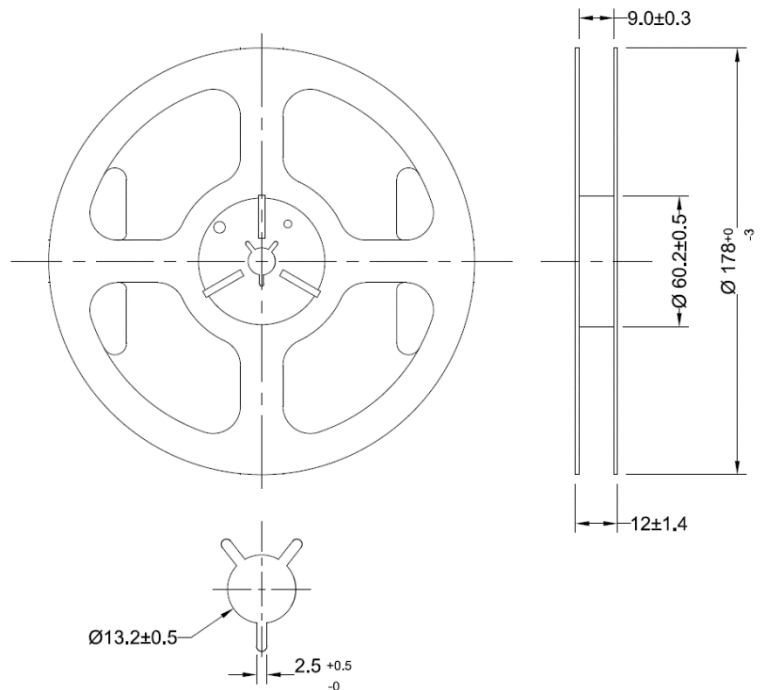
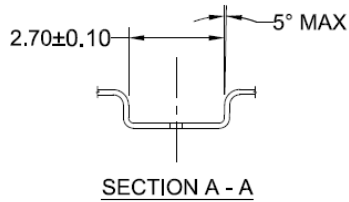
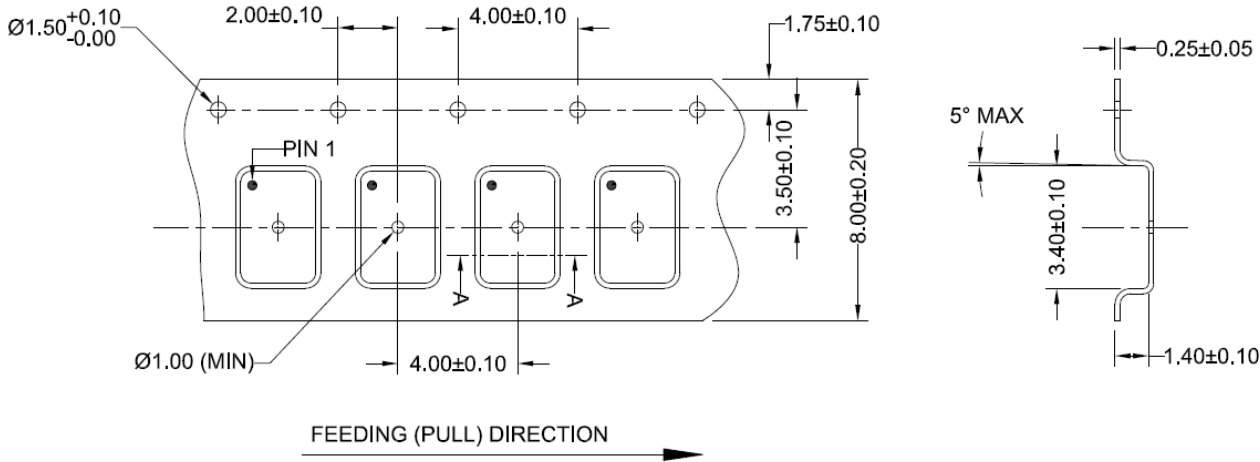

Dimensions: mm

ATTENTION: Abracon LLC's products are COTS – Commercial-Off-The-Shelf products; suitable for Commercial, Industrial and, where designated, Automotive Applications. Abracon's products are not specifically designed for Military, Aviation, Aerospace, Life-dependent Medical applications or any application requiring high reliability where component failure could result in loss of life and/or property. For applications requiring high reliability and/or presenting an extreme operating environment, written consent and authorization from Abracon LLC is required. Please contact Abracon LLC for more information.



5101 Hidden Creek Ln Spicewood TX 78669
 Phone: 512-371-6159 | Fax: 512-351-8858
 For terms and conditions of sales, please visit:
www.abracon.com

REVISED: 05-26-23

ABRACON IS
 ISO9001-2015
 CERTIFIED

X-ON Electronics

Largest Supplier of Electrical and Electronic Components

Click to view similar products for [TCXO Oscillators](#) category:

Click to view products by [Abracon](#) manufacturer:

Other Similar products are found below :

[SIT5000ACC8E-33VQ-19.200000X](#) [SiT5001AI-2E-33N0-48.000000X](#) [TG3225CEN 25.0000M-KFGNNAB](#) [SIT5001AI-2E-33N0-24.000000x](#)
[SIT1566AC-JV-18E-32.768E](#) [AST3TDATACJ5-10.0000MHz](#) [AST3TDATACJ5-20.0000MHz](#) [AST3TDA53TACJ2-19.2000MHz](#)
[AST3TDA53TACJ2-38.8800MHz](#) [AST3TDATACJ5-38.8800MHz](#) [NT0503CC3I287EN10](#) [NT0503CH3I287CN25](#) [NT0503CH3I287CN30.72](#)
[NT0503CC3I287DN20](#) [TG-3541CE 32.7680KXB0](#) [KT1612A26000AAW18TBL](#) [KT1612A26000AAW18NBL](#) [TG-5006CG-12H 26.0000M0](#)
[TG2520SMN 38.4000M-MCGNNM3](#) [X1G004131000900](#) [X1G0041310042](#) [1XXC26000PKA](#) [X1G005441030316](#) [X1G005441020616](#)
[X1G005441030416](#) [X1G005421020416](#) [X1G005441020316](#) [7L26002007](#) [1XTV12800MDA](#) [X1G005421031215](#) [X1G005421020516](#)
[SX1T19.200B010J020S](#) [T132S4-25000ML33DTL](#) [X1G0053710200](#) [NT0503CH3I287EN10](#) [8153H-50.000LH33DTL](#) [NT0503EH3I106EN10](#)
[NT0507BH3I107BN40](#) [NT0503CH3I207EN10](#) [NT0507BH3I507EA10](#) [NT0507BH3I106EA10](#) [BT0507BC3I287CN38.4B](#)
[NT0507BH3I106BA50](#) [NT0503CH3I507CN24.576](#) [OW2EL89CENUXFMYLC-16M](#) [OW2EL89CENUXFMYLC-32M](#)
[OW2EL89CENUXFMYLC-24M](#) [OW7EL89CENUYO3YLC-24M](#) [OW3EL89CENUNFAYLC-26M](#) [OW7EL89CENUYO3YLC-20M](#)