

## REGULATORY COMPLIANCE

 <p><b>Lead Free</b> COMPLIANT</p>	 <p><b>EU RoHS</b> 2011/65 + 2015/863 COMPLIANT</p>	 <p><b>China RoHS</b> COMPLIANT</p>	 <p><b>REACH</b> SVHC COMPLIANT</p>	 <p><b>DRC</b> CONFLICT FREE</p>
--	--	--	--	---

## ITEM DESCRIPTION

MEMS Clock Oscillators LVCMOS (CMOS) 2.5Vdc 4 Pad 2.0mm x 2.5mm Plastic Surface Mount (SMD)

## ELECTRICAL SPECIFICATIONS

<b>Nominal Frequency</b>	1MHz to 125MHz
<b>Frequency Tolerance/Stability</b>	Inclusive of all conditions: Calibration Tolerance at 25°C, Frequency Stability over the Operating Temperature Range, Supply Voltage Change, and Output Load Change ±100ppm Maximum over 0°C to +70°C ±50ppm Maximum over 0°C to +70°C ±25ppm Maximum over 0°C to +70°C ±20ppm Maximum over 0°C to +70°C ±100ppm Maximum over -20°C to +70°C ±50ppm Maximum over -20°C to +70°C ±25ppm Maximum over -20°C to +70°C ±20ppm Maximum over -20°C to +70°C ±100ppm Maximum over -40°C to +85°C ±50ppm Maximum over -40°C to +85°C ±25ppm Maximum over -40°C to +85°C ±20ppm Maximum over -40°C to +85°C
<b>Aging at 25°C</b>	±1.5ppm Maximum First Year
<b>Supply Voltage</b>	3.3Vdc ±10%
<b>Input Current</b>	No Load 5mA Maximum over Nominal Frequency of 1MHz to 20MHz 6mA Maximum over Nominal Frequency of 20.000001MHz to 50MHz 7mA Maximum over Nominal Frequency of 50.000001MHz to 80MHz 9mA Maximum over Nominal Frequency of 80.000001MHz to 125MHz
<b>Output Voltage Logic High (V<sub>OH</sub>)</b>	I <sub>OH</sub> = -4mA 90% of V <sub>DD</sub> Minimum
<b>Output Voltage Logic Low (V<sub>OL</sub>)</b>	I <sub>OL</sub> = +4mA 10% of V <sub>DD</sub> Maximum
<b>Rise/Fall Time</b>	Measured from 20% to 80% of waveform 1.2nSec Typical, 3nSec Maximum
<b>Duty Cycle</b>	Measured at 50% of waveform 50 ±10(%) 50 ±5(%)
<b>Load Drive Capability</b>	15pF Maximum
<b>Output Logic Type</b>	CMOS
<b>Output Control Function</b>	Tri-State (Disabled Output: High Impedance) Power Down (Disabled Output: Logic Low)
<b>Output Control Input Voltage Logic High (V<sub>IH</sub>)</b>	70% of V <sub>DD</sub> Minimum or No Connect to Enable Output
<b>Output Control Input Voltage Logic Low (V<sub>IL</sub>)</b>	30% of V <sub>DD</sub> Maximum to Disable Output
<b>Power Down Output Enable Time</b>	5mSec Maximum (Disabled Output: Logic Low)
<b>Tri-State Output Enable Time</b>	150nSec Maximum (Disabled Output: High Impedance)
<b>Power Down Output Disable Time</b>	150nSec Maximum (Disabled Output: Logic Low)
<b>Tri-State Output Disable Time</b>	150nSec Maximum (Disabled Output: High Impedance)
<b>Standby Current</b>	10µA Maximum (Disabled Output: Logic Low)
<b>Period Jitter (RMS)</b>	2pSec Typical, 4pSec Maximum

RMS Phase Jitter (Fj = 900kHz to 7.5MHz; Random)	0.5pSec Typical, 1pSec Maximum
RMS Phase Jitter (Fj = 12kHz to 20MHz; Random)	1.5pSec Typical, 3pSec Maximum
Start Up Time	5mSec Maximum
Storage Temperature Range	-65°C to +150°C

## PART NUMBERING GUIDE

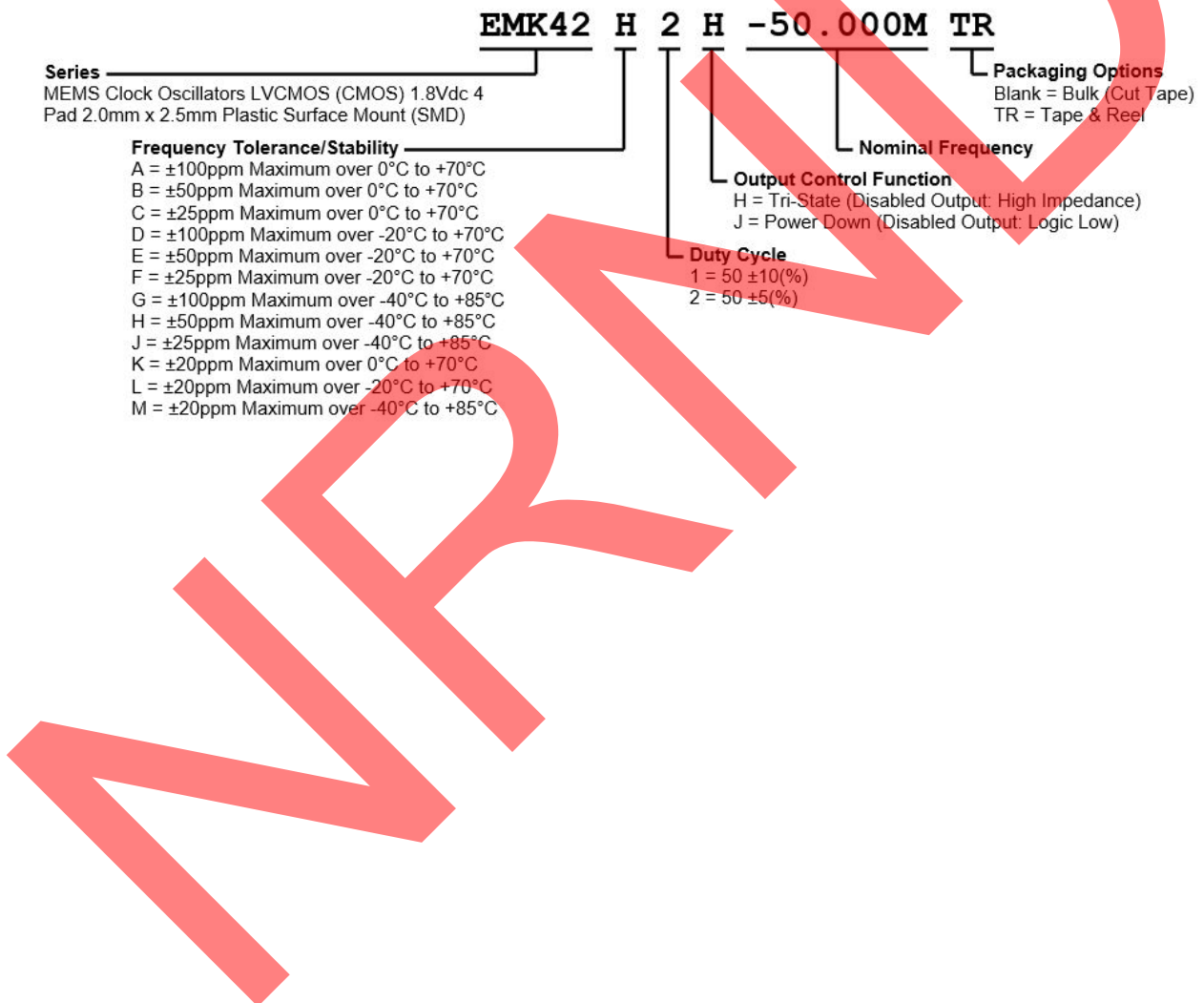

**MECHANICAL DIMENSIONS**

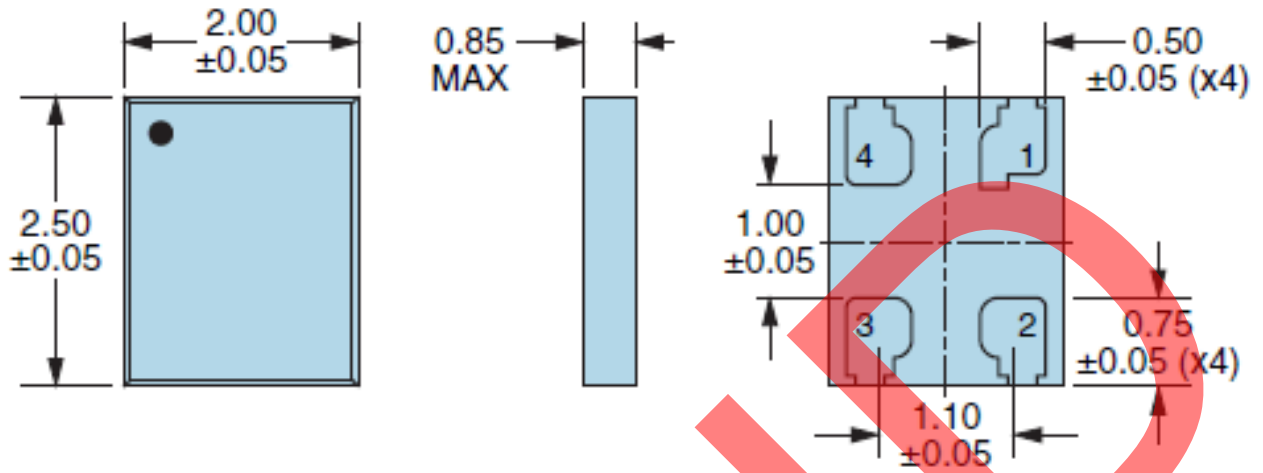

**SUGGESTED SOLDER PAD LAYOUT**

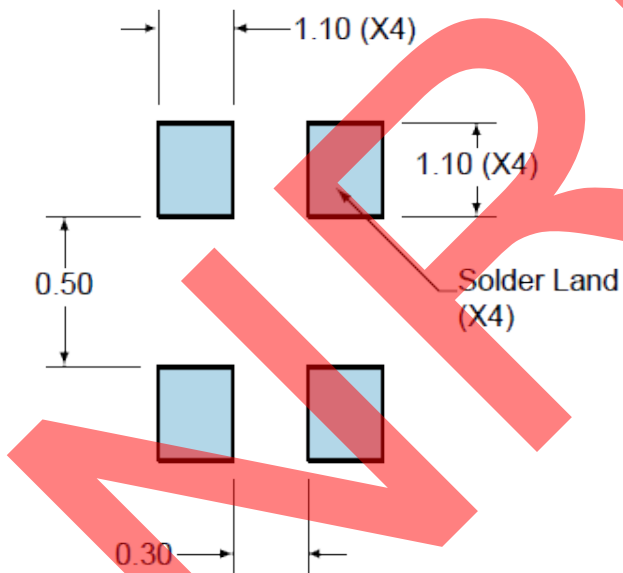

PIN	CONNECTION
1	Power Down Or Tri-State
2	Ground
3	Output
4	Supply Voltage

All Tolerances are  $\pm 0.1$

**All Dimensions in Millimeters**

**OUTPUT WAVEFORM & TIMING DIAGRAM**

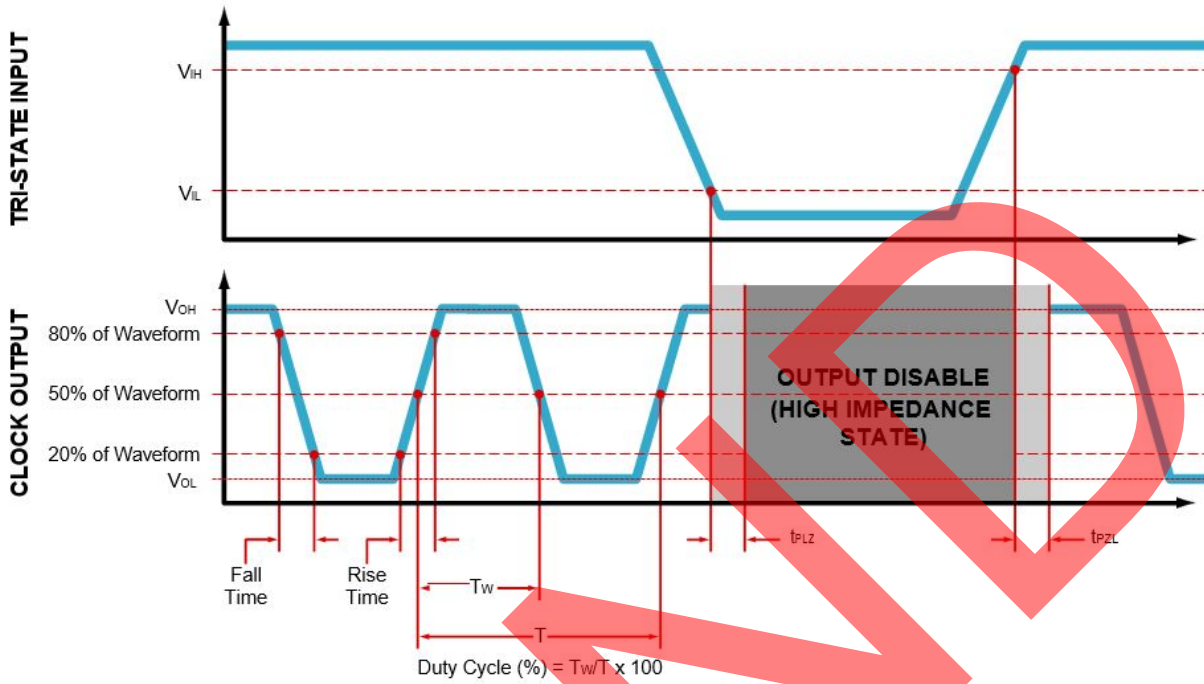

## TEST CIRCUIT FOR CMOS OUTPUT

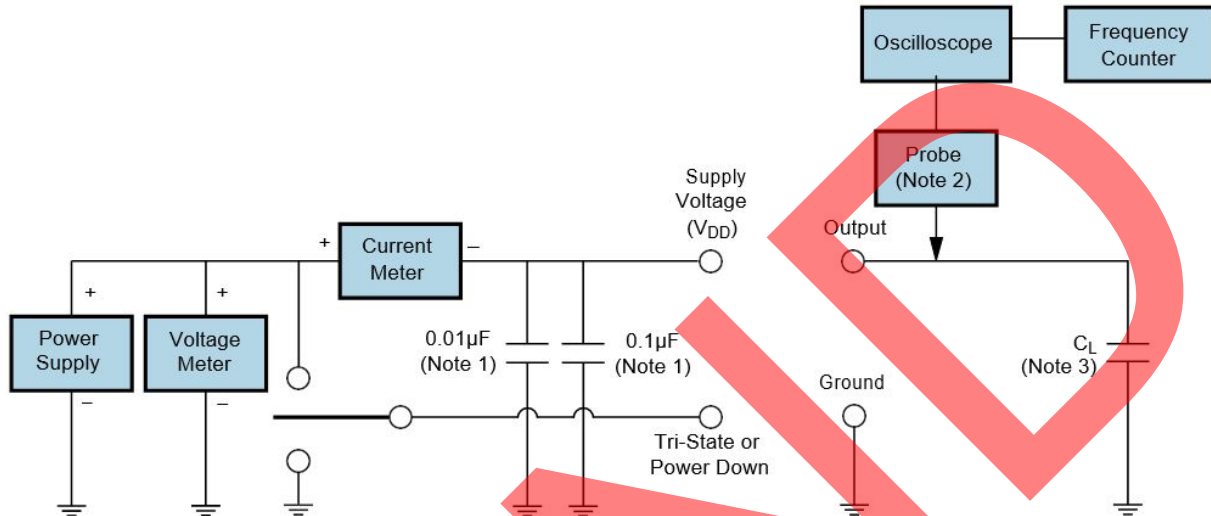

**Note 1:** An external 0.01µF ceramic bypass capacitor in parallel with a 0.1µF high frequency ceramic bypass capacitor close (less than 2mm) to the package ground and supply voltage pin is required.

**Note 2:** A low input capacitance (<12pF), 10X Attenuation Factor, High Impedance (>10Mohms), and High bandwidth (>300MHz) Passive probe is recommended.

**Note 3:** Capacitance value CL includes sum of all probe and fixture capacitance. See applicable specification sheet for 'Load Drive Capability'.

**TAPE & REEL DIMENSIONS**

Quantity per Reel: 1,000 Units

All Dimensions in Millimeters

Compliant to EIA-481

X = 8.00±0.30 or 12±0.30

Y = 3.50±0.05 or 5.5±0.05

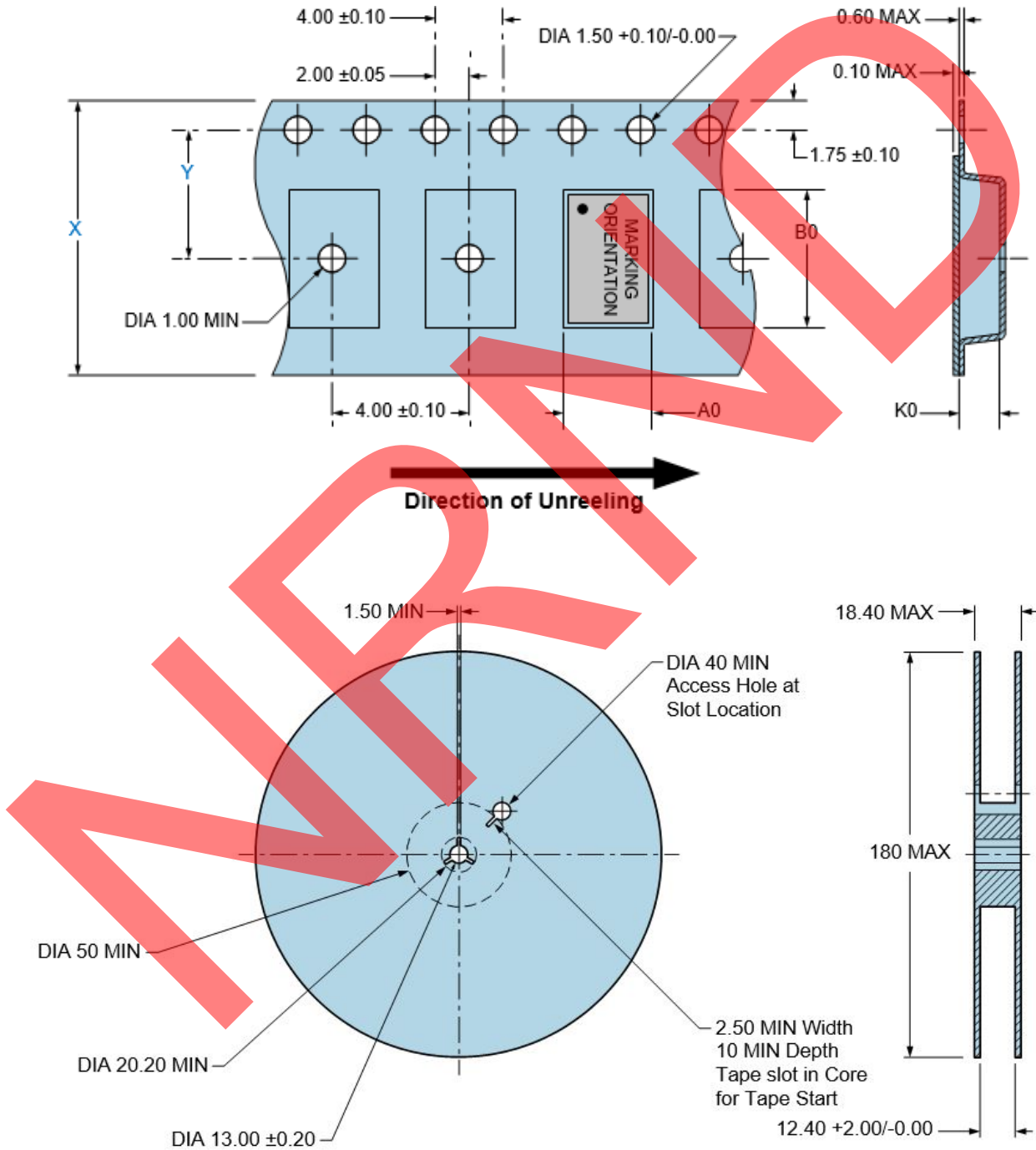

RECOMMENDED SOLDER REFLOW METHOD

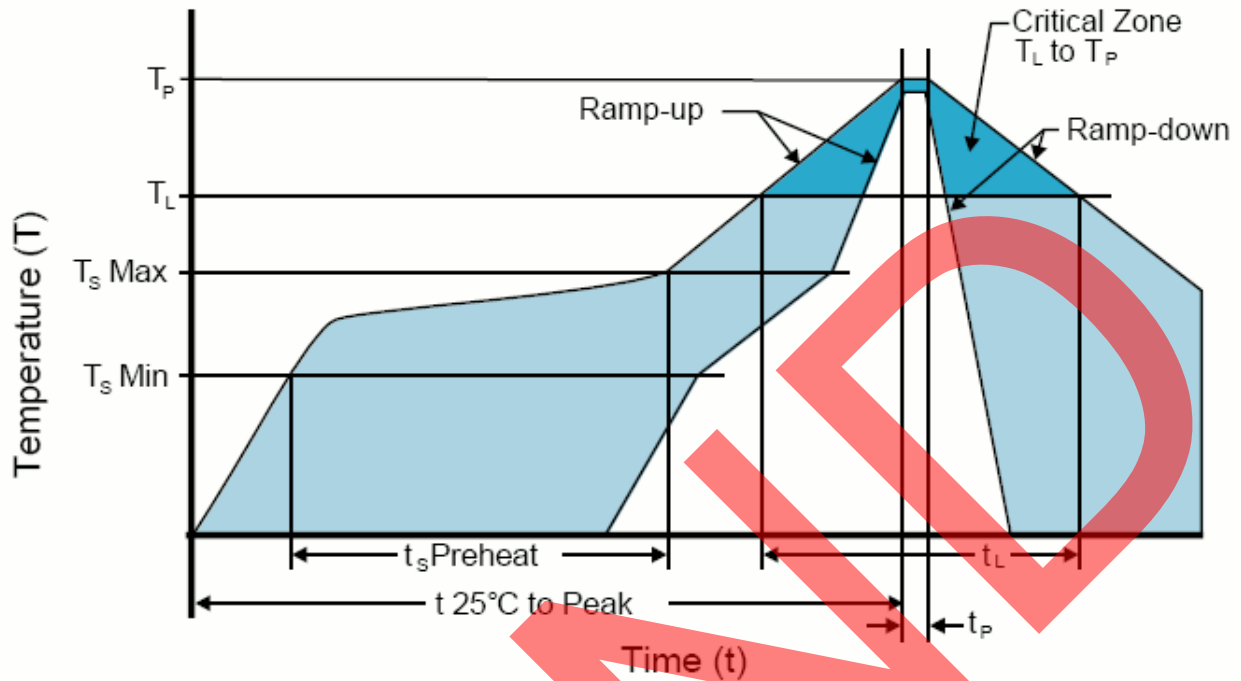

**HIGH TEMPERATURE INFRARED/CONVECTION**

T <sub>S</sub> MAX to T <sub>L</sub> (Ramp-up Rate)	3°C/Second Maximum
<b>Preheat</b>	
- Temperature Minimum (T <sub>S</sub> MIN)	150°C
- Temperature Typical (T <sub>S</sub> TYP)	175°C
- Temperature Maximum(T <sub>S</sub> MAX)	200°C
- Time (t <sub>s</sub> MIN)	60 - 180 Seconds
<b>Ramp-up Rate (T<sub>L</sub> to T<sub>P</sub>)</b>	3°C/Second Maximum
<b>Time Maintained Above:</b>	
- Temperature (T <sub>L</sub> )	217°C
- Time (t <sub>L</sub> )	60 - 150 Seconds
<b>Peak Temperature (T<sub>P</sub>)</b>	260°C Maximum for 10 Seconds Maximum
<b>Target Peak Temperature(T<sub>P</sub> Target)</b>	250°C +0/-5°C
<b>Time within 5°C of actual peak (t<sub>P</sub>)</b>	20 - 40 Seconds
<b>Ramp-down Rate</b>	6°C/Second Maximum
<b>Time 25°C to Peak Temperature (t)</b>	8 Minutes Maximum
<b>Moisture Sensitivity Level</b>	Level 1
<b>Additional Notes</b>	Temperatures shown are applied to body of device.

**High Temperature Manual Soldering**

260°C Maximum for 5 Seconds Maximum, 2 times Maximum. (Temperatures shown are applied to body of device.)

RECOMMENDED SOLDER REFLOW METHOD

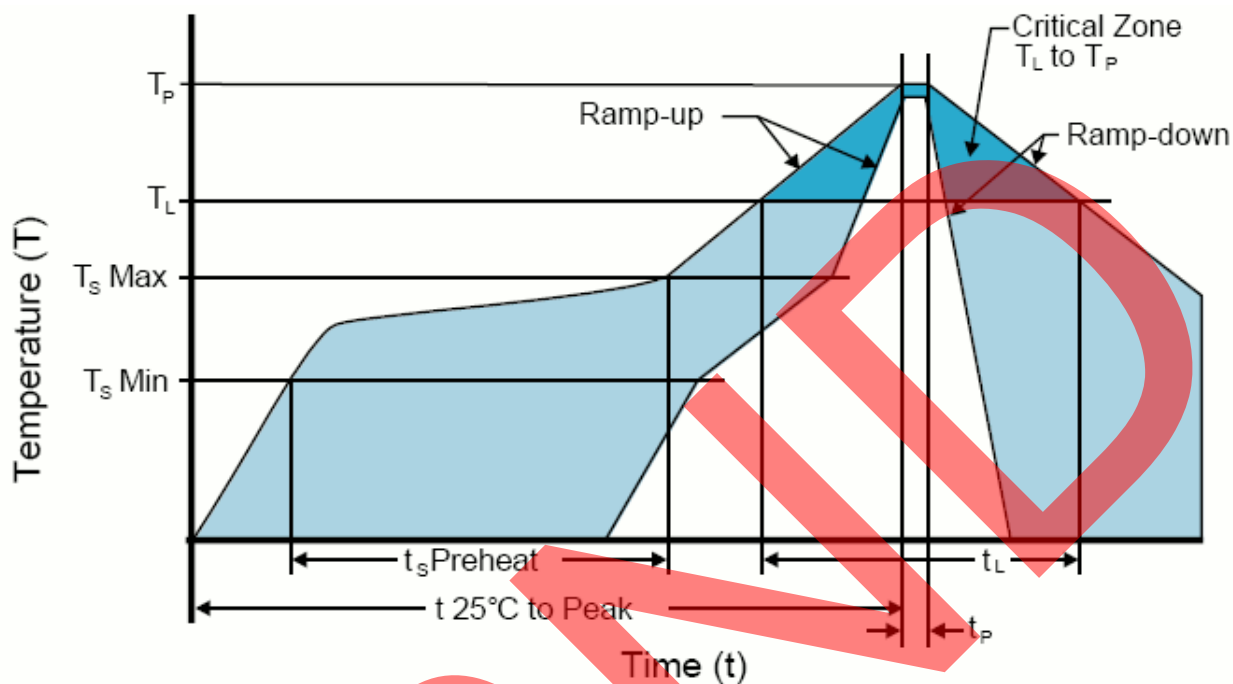

**LOW TEMPERATURE INFRARED/CONVECTION**

<b><math>T_S \text{ MAX}</math> to <math>T_L</math> (Ramp-up Rate)</b>	5°C/Second Maximum
<b>Preheat</b>	
- Temperature Minimum ( $T_S \text{ MIN}$ )	N/A
- Temperature Typical ( $T_S \text{ TYP}$ )	150°C
- Temperature Maximum ( $T_S \text{ MAX}$ )	N/A
- Time ( $t_s \text{ MIN}$ )	60 - 120 Seconds
<b>Ramp-up Rate (<math>T_L</math> to <math>T_P</math>)</b>	5°C/Second Maximum
<b>Time Maintained Above:</b>	
- Temperature ( $T_L$ )	150°C
- Time ( $t_L$ )	200 Seconds Maximum
<b>Peak Temperature (<math>T_P</math>)</b>	240°C Maximum
<b>Target Peak Temperature (<math>T_P \text{ Target}</math>)</b>	240°C Maximum 2 Times / 230°C Maximum 1 Time
<b>Time within 5°C of actual peak (<math>t_P</math>)</b>	10 Seconds Maximum 2 Times / 80 Seconds Maximum 1 Time
<b>Ramp-down Rate</b>	5°C/Second Maximum
<b>Time 25°C to Peak Temperature (<math>t</math>)</b>	N/A
<b>Moisture Sensitivity Level</b>	Level 1
<b>Additional Notes</b>	Temperatures shown are applied to body of device.

**Low Temperature Manual Soldering**

185°C Maximum for 10 Seconds Maximum, 2 times Maximum. (Temperatures shown are applied to body of device.)



## X-ON Electronics

Largest Supplier of Electrical and Electronic Components

*Click to view similar products for [Standard Clock Oscillators](#) category:*

*Click to view products by [Abracon](#) manufacturer:*

Other Similar products are found below :

[601252](#) [F335-12](#) [F335-25](#) [F535L-33.333](#) [F535L-50](#) [ASV-20.000MHZ-LR-T](#) [ECS-2018-160-BN-TR](#) [MXO45HS-2C-66.6666MHZ](#)  
[SiT8209AI-32-33E-125.000000](#) [SIT8918AA-11-33S-50.000000G](#) [SM4420TEV-40.0M-T1K](#) [F335-24](#) [F335-40](#) [F535L-10](#) [F535L-12](#) [F535L-16](#) [F535L-24](#) [F535L-27](#) [F535L-48](#) [PE7744DW-100.0M](#) [CSX-750FCC14745600T](#) [ASF1-3.686MHZ-N-K-S](#) [XO57CTECNA3M6864](#) [ECS-2100A-147.4](#) [601251](#) [EP16E7E2H26.000MTR](#) [SIT8918AA-11-33S-16.000000G](#) [XO3003](#) [9120AC-2D2-33E212.500000](#) [9102AI-243N25E100.00000](#) [8208AC-82-18E-25.00000](#) [ASDK2-32.768KHZ-LR-T3](#) [8008AI-72-XXE-24.545454E](#) [8004AC-13-33E-133.33000X](#) [AS-4.9152-16-SMD-TR](#) [ASFL1-48.000MHZ-LC-T](#) [SIT8920AM-31-33E-25.0000](#) [DSC1028DI2-019.2000](#) [9121AC-2C3-25E100.00000](#) [9102AI-233N33E100.00000X](#) [9102AI-233N25E200.00000](#) [9102AI-232H25S125.00000](#) [9102AI-133N25E200.00000](#) [9102AC-283N25E200.00000](#) [9001AC-33-33E1-30.000](#) [XLH536125.000JS4I](#) [3921AI-2CF-33NZ125.000000](#) [5730-1SF](#) [PXA000010](#) [SIT1602BC-83-33E-10.000000Y](#)