

REGULATORY COMPLIANCE

 Lead Free COMPLIANT	 EU RoHS 2011/65 + 2015/863 COMPLIANT	 China RoHS COMPLIANT	 REACH SVHC COMPLIANT	 DRC CONFLICT FREE
---	---	---	---	---

ITEM DESCRIPTION

Quartz Crystal Clock Oscillators XO (SPXO) LVCMOS (CMOS) 3.3Vdc 4 Pad 5.0mm x 7.0mm Ceramic Surface Mount (SMD)

ELECTRICAL SPECIFICATIONS

Nominal Frequency	1MHz to 106.25MHz
Frequency Tolerance/Stability	Inclusive of all conditions: Calibration Tolerance at 25°C, Frequency Stability over the Operating Temperature Range, Supply Voltage Change, Output Load Change, First Year Aging at 25°C, Shock, and Vibration ±100ppm Maximum ±50ppm Maximum
Aging at 25°C	±5ppm/year Maximum
Operating Temperature Range	-20°C to +70°C -40°C to +85°C
Supply Voltage	3.3Vdc ±10%
Input Current	Unloaded 28mA Maximum
Output Voltage Logic High (V_{OH})	I _{OH} = -8mA V _{dd} -0.4Vdc Minimum
Output Voltage Logic Low (V_{OL})	I _{OL} = +8mA 0.4Vdc Maximum
Rise/Fall Time	Measured at 20% to 80% of waveform 4nSec Maximum
Duty Cycle	Measured at 50% of waveform 50 ±10(%) 50 ±5(%) (Only available over Nominal Frequency range of 1M to 50M)
Load Drive Capability	30pF Maximum over Nominal Frequency of 1MHz to 50MHz 15pF Maximum over Nominal Frequency of 50.000001MHz to 106.25MHz
Output Logic Type	CMOS
Pin 1 Connection	Power Down (Disable Output: Logic Low) Tri-State (Disabled Output: High Impedance)
Tri-State Input Voltage (V_{IH} and V_{IL})	70% of V _{dd} Minimum to enable output, 20% of V _{dd} Maximum to disable output, No Connect to enable output.
Standby Current	20µA Maximum (Pin 1 = Ground, Disable Output: Logic Low)
Disable Current	16mA Maximum (Pin 1 = Ground, Disabled Output: High Impedance)
Absolute Clock Jitter	±250pSec Maximum, ±100pSec Typical over Nominal Frequency of 1MHz to 33MHz ±125pSec Maximum, ±75pSec Typical over Nominal Frequency of 33.000001MHz to 106.25MHz
One Sigma Clock Period Jitter	±50pSec Maximum over Nominal Frequency of 1MHz to 33MHz ±40pSec Maximum over Nominal Frequency of 33.000001MHz to 106.25MHz
Start Up Time	10mSec Maximum
Storage Temperature Range	-55°C to +125°C

PART NUMBERING GUIDE

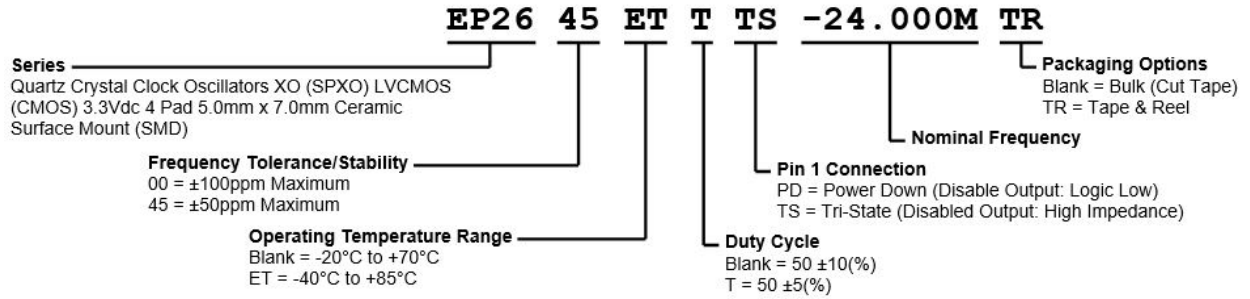

MECHANICAL DIMENSIONS

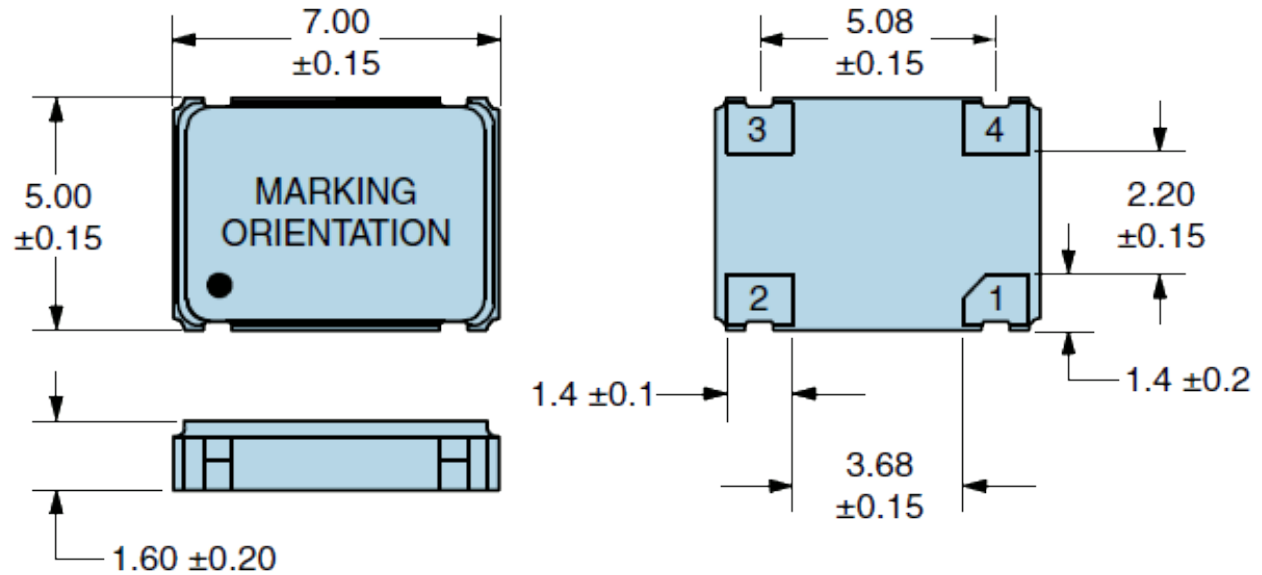

SUGGESTED SOLDER PAD LAYOUT

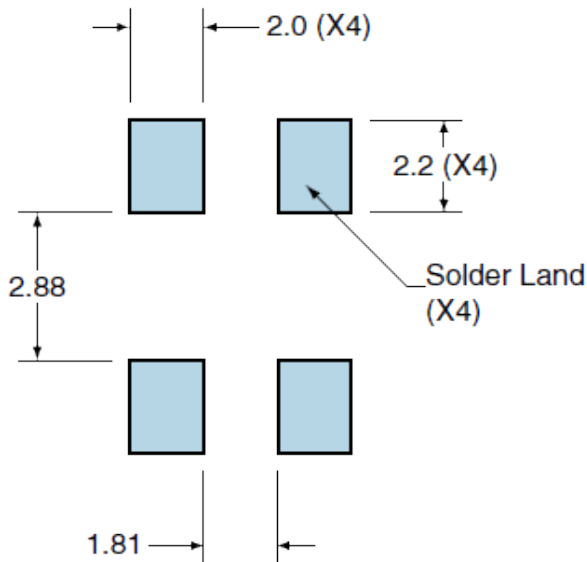

PIN	CONNECTION
1	Power Down (Logic Low) Or Tri-State (High Impedance)
2	Ground/Case Ground
3	Output
4	Supply Voltage

All Tolerances are ±0.1

All Dimensions in Millimeters

OUTPUT WAVEFORM & TIMING DIAGRAM

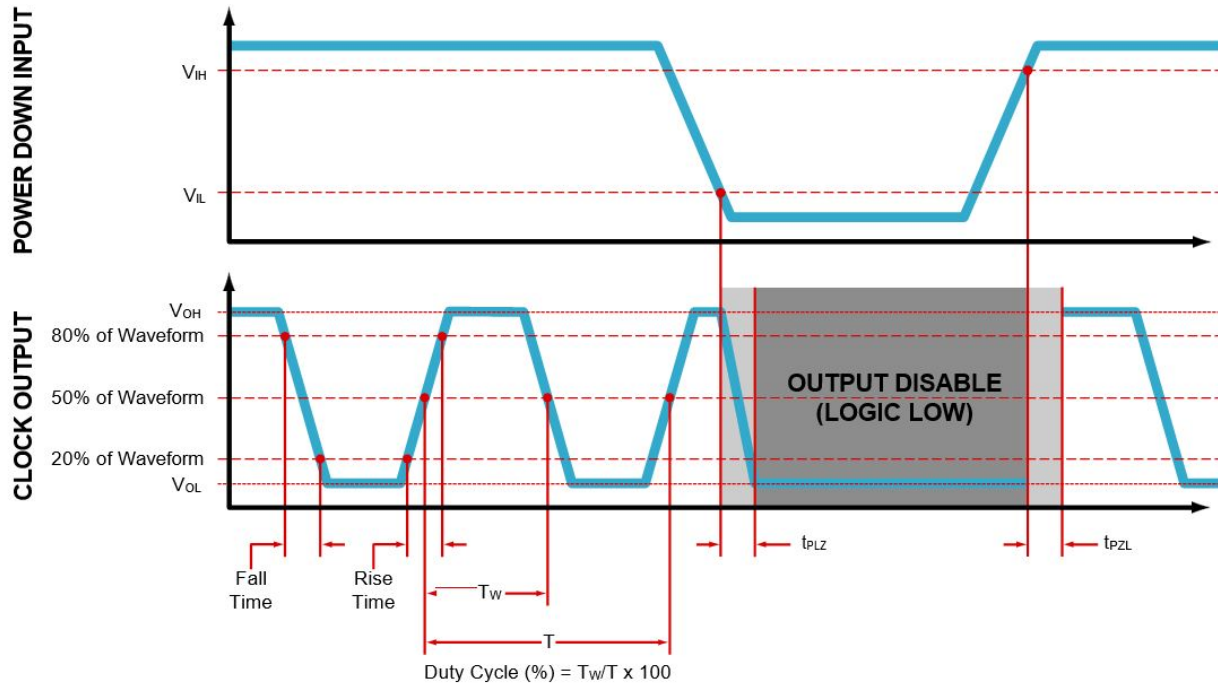

TEST CIRCUIT FOR CMOS OUTPUT

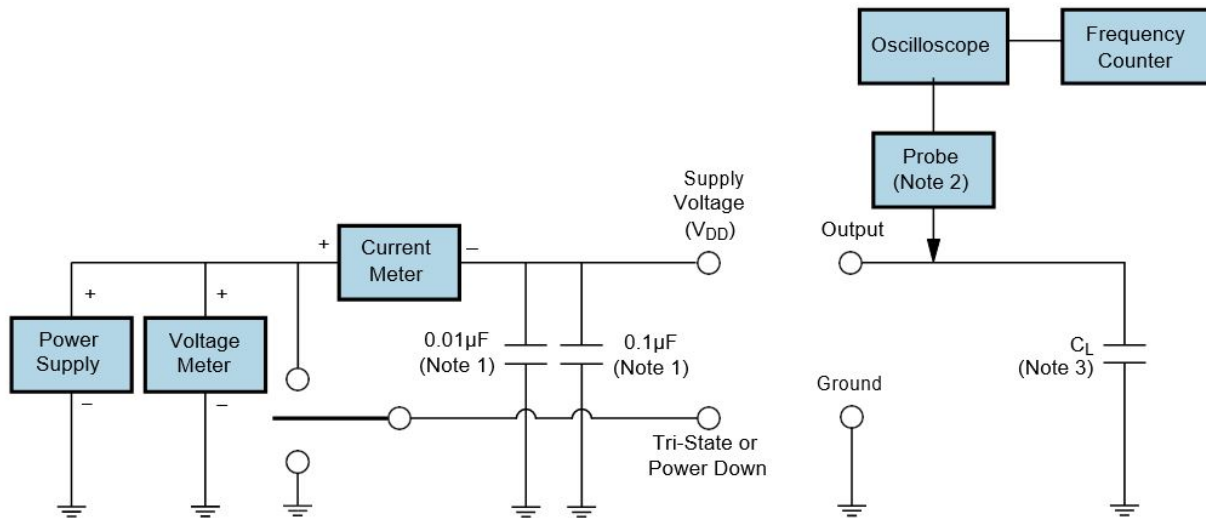

Note 1: An external 0.01µF ceramic bypass capacitor in parallel with a 0.1µF high frequency ceramic bypass capacitor close (less Than 2mm) to the package ground and supply voltage pin is required.

Note 2: A low input capacitance (<12pF), 10X Attenuation Factor, High Impedance (>10Mohms), and High bandwidth (>300MHz) passive probe is recommended.

Note 3: Capacitance value CL includes sum of all probe and fixture capacitance. See applicable specification sheet for 'Load Drive Capability'.

TAPE & REEL DIMENSIONS

Quantity per Reel: 1,000 Units

All Dimensions in Millimeters

Compliant to EIA-481

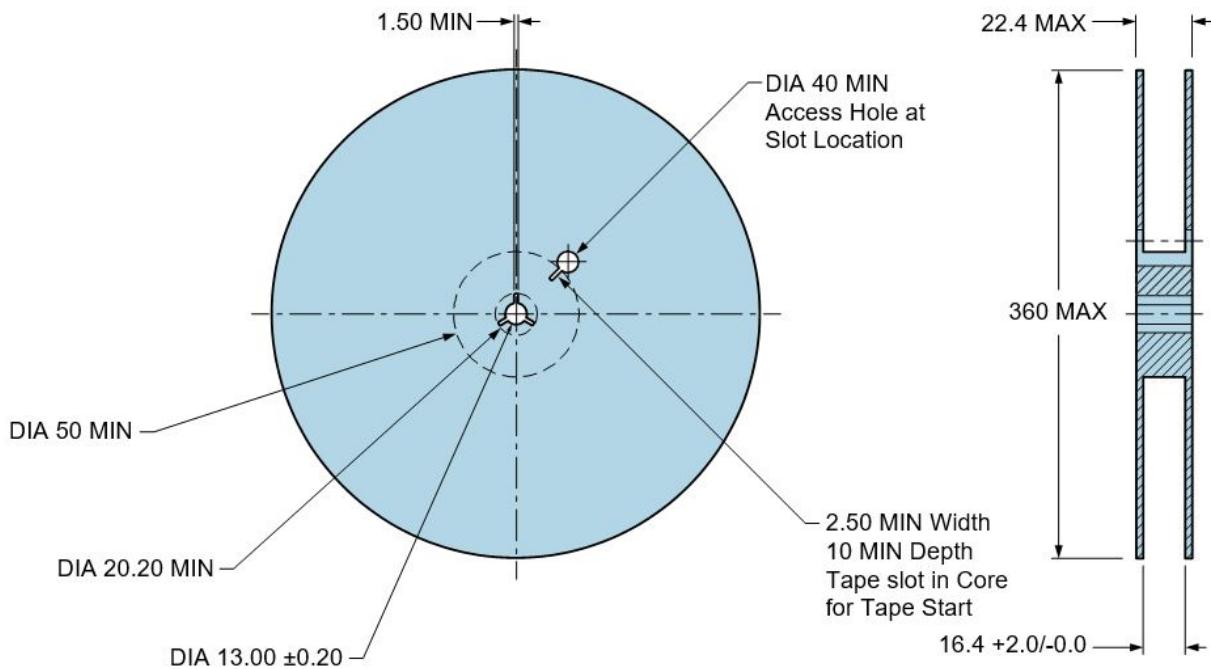
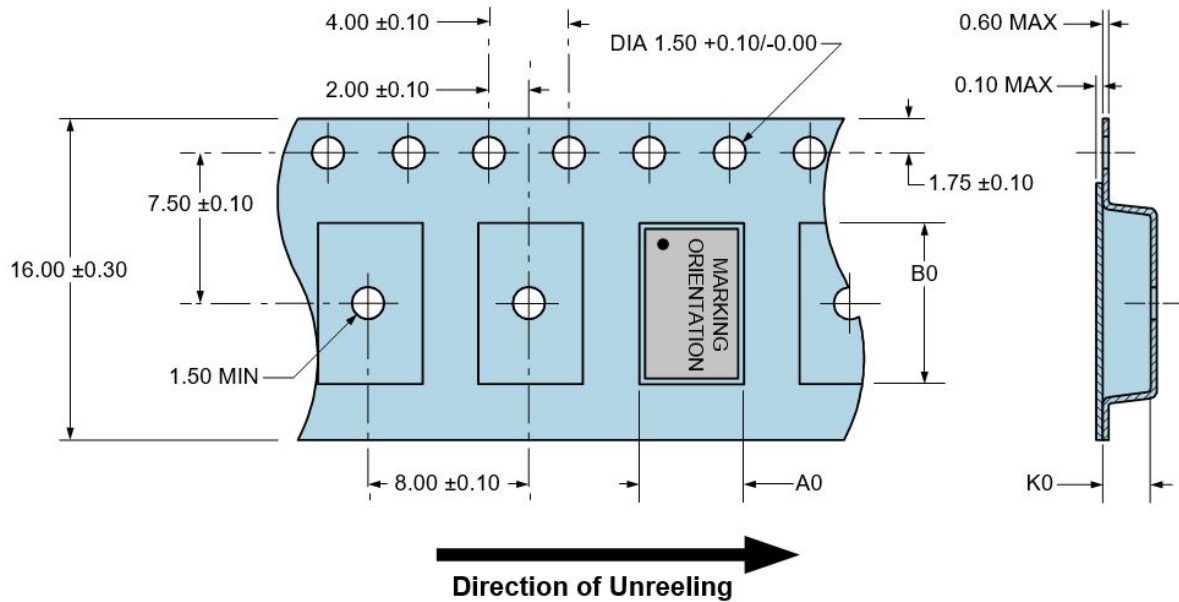

RECOMMENDED SOLDER REFLOW METHOD

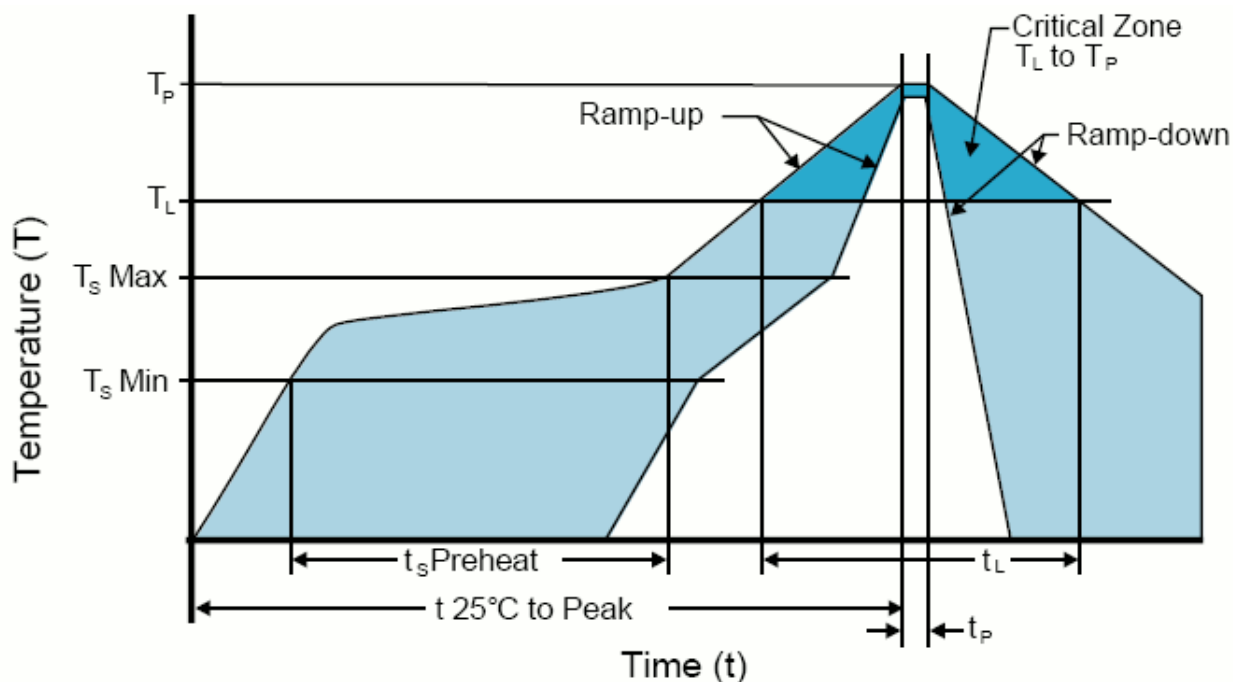

HIGH TEMPERATURE INFRARED/CONVECTION

T _S MAX to T _L (Ramp-up Rate)	3°C/Second Maximum
Preheat	
- Temperature Minimum (T _S MIN)	150°C
- Temperature Typical (T _S TYP)	175°C
- Temperature Maximum(T _S MAX)	200°C
- Time (t _s MIN)	60 - 180 Seconds
Ramp-up Rate (T _L to T _P)	3°C/Second Maximum
Time Maintained Above:	
- Temperature (T _L)	217°C
- Time (t _L)	60 - 150 Seconds
Peak Temperature (T _P)	260°C Maximum for 10 Seconds Maximum
Target Peak Temperature(T _P Target)	250°C +0/-5°C
Time within 5°C of actual peak (t _p)	20 - 40 Seconds
Ramp-down Rate	6°C/Second Maximum
Time 25°C to Peak Temperature (t)	8 Minutes Maximum
Moisture Sensitivity Level	Level 1
Additional Notes	Temperatures shown are applied to body of device.

High Temperature Manual Soldering

260°C Maximum for 5 Seconds Maximum, 2 times Maximum. (Temperatures shown are applied to body of device.)

RECOMMENDED SOLDER REFLOW METHOD

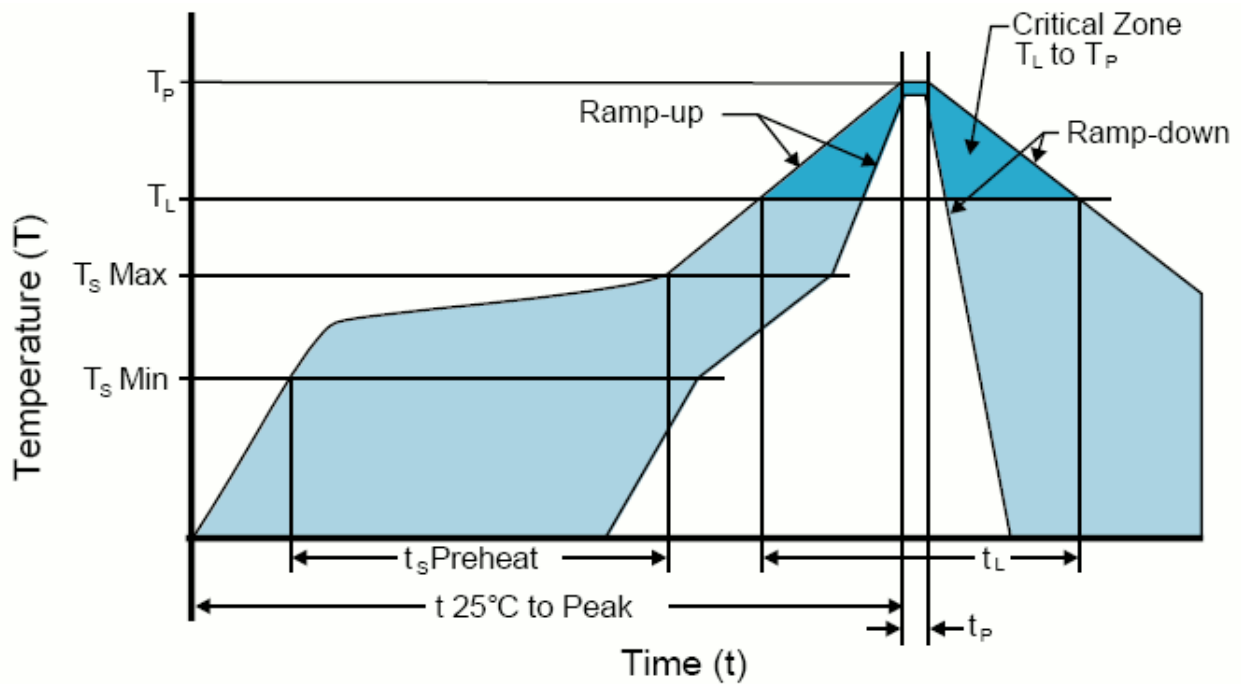

LOW TEMPERATURE INFRARED/CONVECTION

T _S MAX to T _L (Ramp-up Rate)	5°C/Second Maximum
Preheat	
- Temperature Minimum (T _S MIN)	N/A
- Temperature Typical (T _S TYP)	150°C
- Temperature Maximum(T _S MAX)	N/A
- Time (t _S MIN)	60 - 120 Seconds
Ramp-up Rate (T _L to T _P)	5°C/Second Maximum
Time Maintained Above:	
- Temperature (T _L)	150°C
- Time (t _L)	200 Seconds Maximum
Peak Temperature (T _P)	240°C Maximum
Target Peak Temperature(T _P Target)	240°C Maximum 2 Times/230°C Maximum 1Time
Time within 5°C of actual peak (t _P)	10 Seconds Maximum 2 Times / 80 Seconds Maximum 1 Time
Ramp-down Rate	5°C/Second Maximum
Time 25°C to Peak Temperature (t)	N/A
Moisture Sensitivity Level	Level 1
Additional Notes	Temperatures shown are applied to body of device.

Low Temperature Manual Soldering

185°C Maximum for 10 Seconds Maximum, 2 times Maximum. (Temperatures shown are applied to body of device.)

X-ON Electronics

Largest Supplier of Electrical and Electronic Components

Click to view similar products for [Standard Clock Oscillators](#) category:

Click to view products by [Abracon](#) manufacturer:

Other Similar products are found below :

[601252](#) [F335-12](#) [F335-25](#) [F535L-33.333](#) [F535L-50](#) [ASV-20.000MHZ-LR-T](#) [ECS-2018-160-BN-TR](#) [MXO45HS-2C-66.6666MHZ](#)
[SiT8209AI-32-33E-125.000000](#) [SIT8918AA-11-33S-50.000000G](#) [SM4420TEV-40.0M-T1K](#) [F335-24](#) [F335-40](#) [F535L-10](#) [F535L-12](#) [F535L-16](#) [F535L-24](#) [F535L-27](#) [F535L-48](#) [PE7744DW-100.0M](#) [CSX-750FCC14745600T](#) [ASF1-3.686MHZ-N-K-S](#) [XO57CTECNA3M6864](#) [ECS-2100A-147.4](#) [601251](#) [EP16E7E2H26.000MTR](#) [SIT8918AA-11-33S-16.000000G](#) [XO3003](#) [9120AC-2D2-33E212.500000](#) [9102AI-243N25E100.00000](#) [8208AC-82-18E-25.00000](#) [ASDK2-32.768KHZ-LR-T3](#) [8008AI-72-XXE-24.545454E](#) [8004AC-13-33E-133.33000X](#) [AS-4.9152-16-SMD-TR](#) [ASFL1-48.000MHZ-LC-T](#) [SIT8920AM-31-33E-25.0000](#) [DSC1028DI2-019.2000](#) [9121AC-2C3-25E100.00000](#) [9102AI-233N33E100.00000X](#) [9102AI-233N25E200.00000](#) [9102AI-232H25S125.00000](#) [9102AI-133N25E200.00000](#) [9102AC-283N25E200.00000](#) [9001AC-33-33E1-30.000](#) [XLH536125.000JS4I](#) [3921AI-2CF-33NZ125.000000](#) [5730-1SF](#) [PXA000010](#) [XLH535050.000000X](#)