

OnBoard 868 MHz - EVB

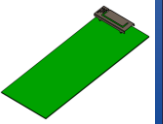

PRO-EB-472

Request Samples



Check Inventory



120.0 x 50.0 mm
RoHS/RoHS II Compliant
MSL Level = 1

Description

The PRO-EB-472 Evaluation board is designed to provide a means to facilitate engineering evaluation of the OnBoard antenna: PRO-OB-471 for 868 MHz operation. With a typical operating frequency range of 860 ~ 870 MHz, the antenna can be used for LPWA/LoRA/SigFox/ISM applications.

To evaluate the performance of the antenna, calibrate the Vector Network analyzer (VNA) for the testing frequency band and connect the evaluation board to the calibrated port using the given SMA connector on the board.

Product Image

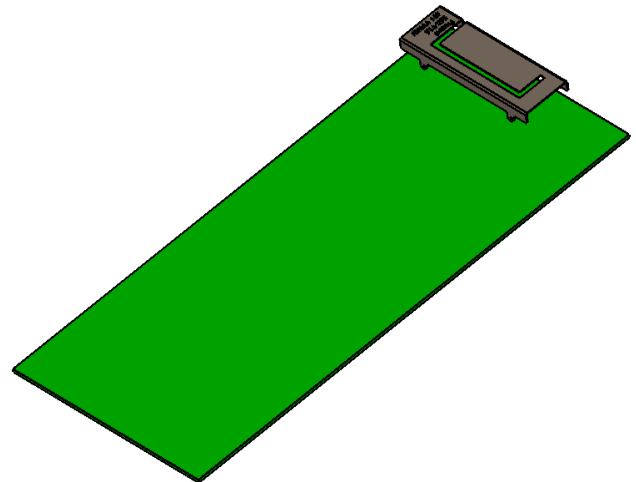
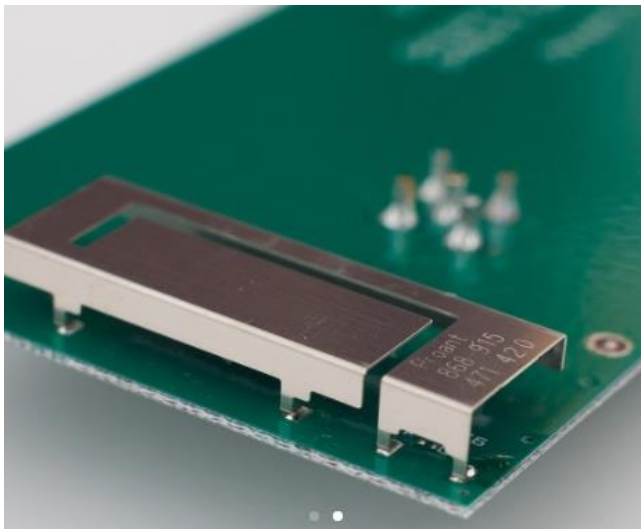

Antenna Image

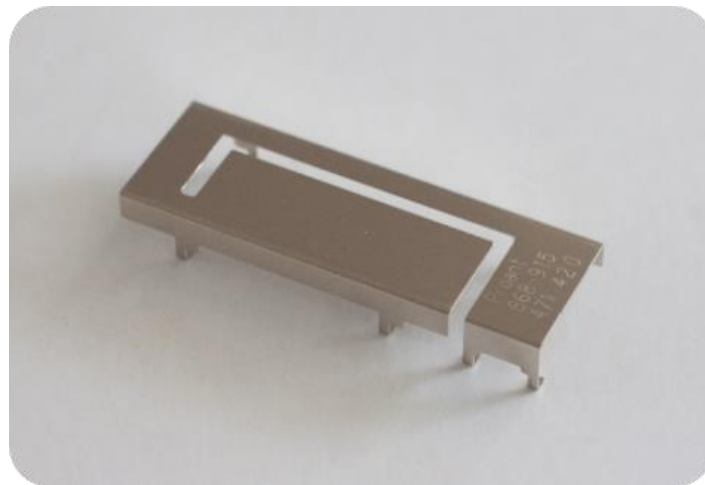

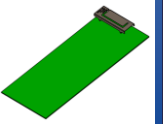

PRO-EB-472

Request Samples



Check Inventory



120.0 x 50.0 mm
RoHS/RoHS II Compliant
MSL Level = 1

Electrical Specification

Parameter	Specification	Unit
Operating Frequency	860 - 870	MHz
Center Frequency	865	
Return Loss	< -9.9	dB
Polarization	Mixed Linear	
Peak Gain	1.7	dB _i
Efficiency	> 63	%
Impedance	50	Ω

Note: All measurements were conducted on the evaluation board in free space. Performance will vary depending on the ground plane, application, and environment.

Mechanical Specification

Parameter	Specification
Evaluation board Dimension	120 x 50 mm

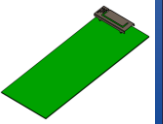

PRO-EB-472

Request Samples



Check Inventory



120.0 x 50.0 mm
RoHS/RoHS II Compliant
MSL Level = 1

Antenna Dimension

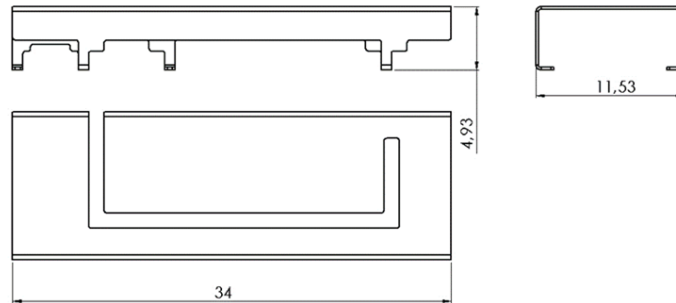

Unit : mm

Antenna pins and keep-out block

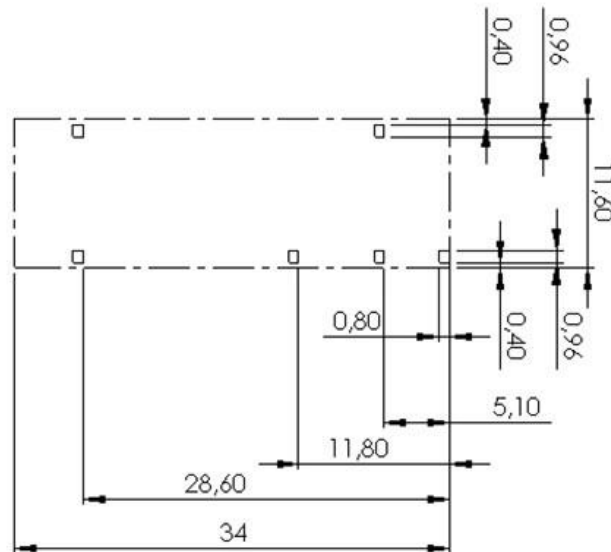

Unit : mm

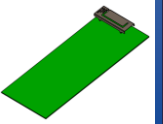

PRO-EB-472

Request Samples



Check Inventory



120.0 x 50.0 mm
RoHS/RoHS II Compliant
MSL Level = 1

PCB layout and antenna pin numbering

The antenna uses PIFA technology and should thus be mounted on a ground plane. If there are several layers in the PCB, there is an advantage to add vias for smooth interconnection of the ground areas to avoid splits in the ground plane. It is also important that there is a ground clearance around the NC pads and the RF feed pad, through all layers of the PCB. It is recommended to implement a matching network to optimize the antenna impedance in your application. The components can be positioned under the antenna. See recommendations in the figures below.

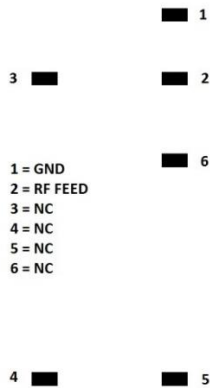

Pin configuration



PCB Layout (from evaluation board)

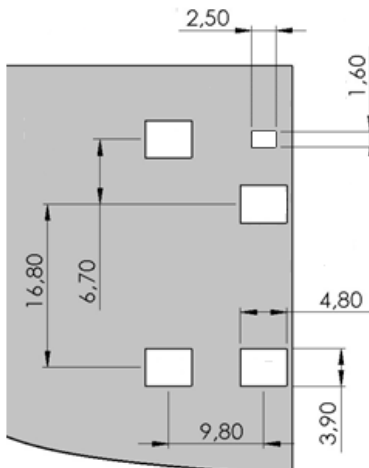
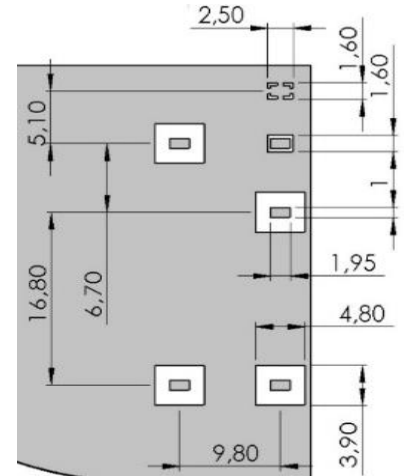

Clearance through all layers

Unit: mm

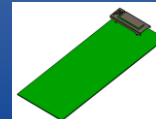

PRO-EB-472

Request Samples



Check Inventory



120.0 x 50.0 mm

RoHS/RoHS II Compliant

MSL Level = 1

Measurement Setup

The antenna measurements were done with the OnBoard SMD 868 MHz evaluation board (PRO-EB-472, 120 x 50 mm) - measured in free space.

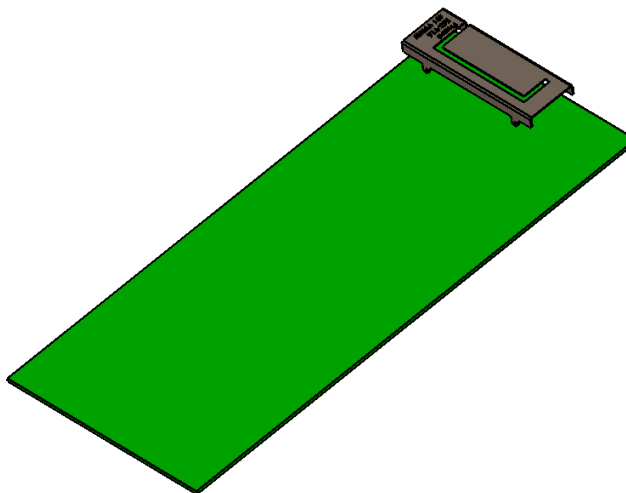

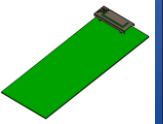

PRO-EB-472

Request Samples



Check Inventory



120.0 x 50.0 mm
RoHS/RoHS II Compliant
MSL Level = 1

Reflection Characteristics – Return Loss

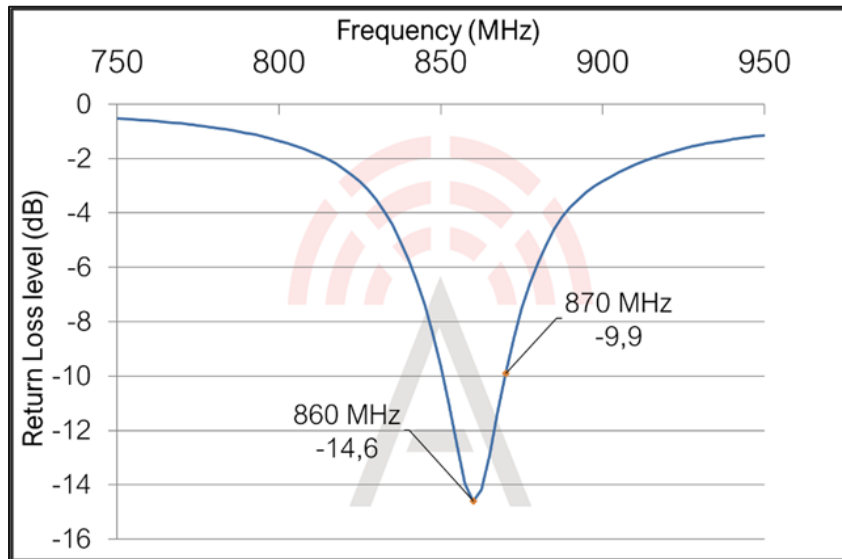

Total Radiation Efficiency

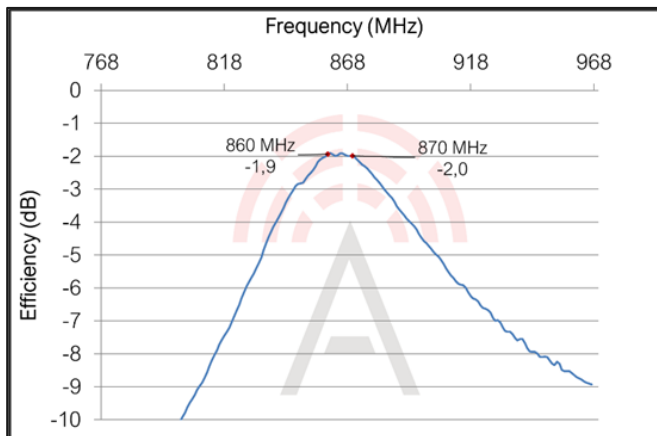

Maximum Radiation Gain

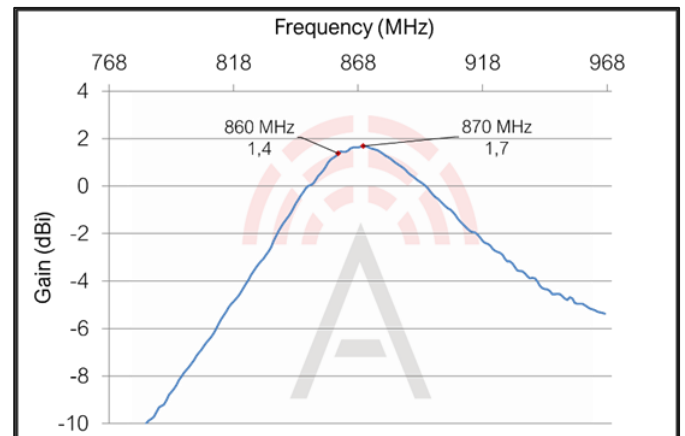

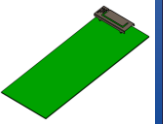

PRO-EB-472

Request Samples



Check Inventory



120.0 x 50.0 mm
 RoHS/RoHS II Compliant
 MSL Level = 1

Radiation Characteristics – 2D Pattern (868 MHz)

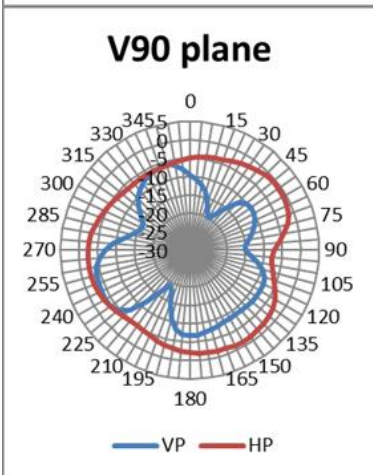
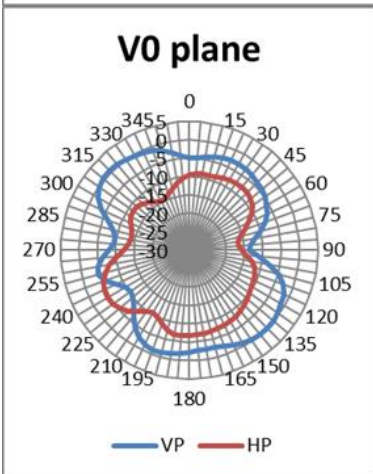
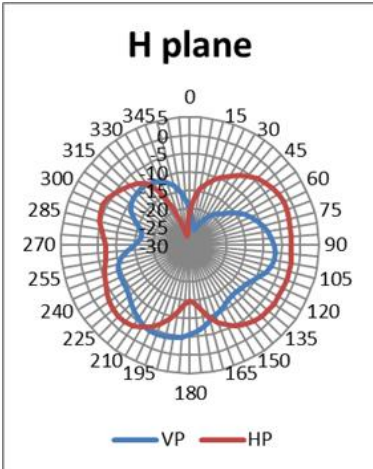

VP: Vertical Polarization
 HP: Horizontal Polarization

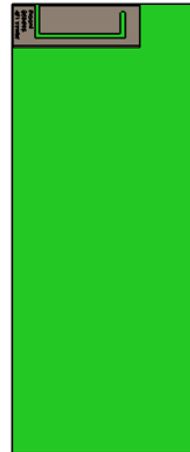

Unit: dBi

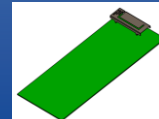

PRO-EB-472

Request Samples



Check Inventory



120.0 x 50.0 mm

RoHS/RoHS II Compliant

MSL Level = 1

Evaluation Board Outline & Matching Circuit

The evaluation board is developed to simplify antenna (PRO-OB-471) testing and evaluation. It has an arbitrary size of 120 x 50 mm and includes an SMA connector. The purpose is to give a reference design for an optimal antenna implementation. The evaluation board can also be used to test other implementations by cutting and soldering the PCB into any device.

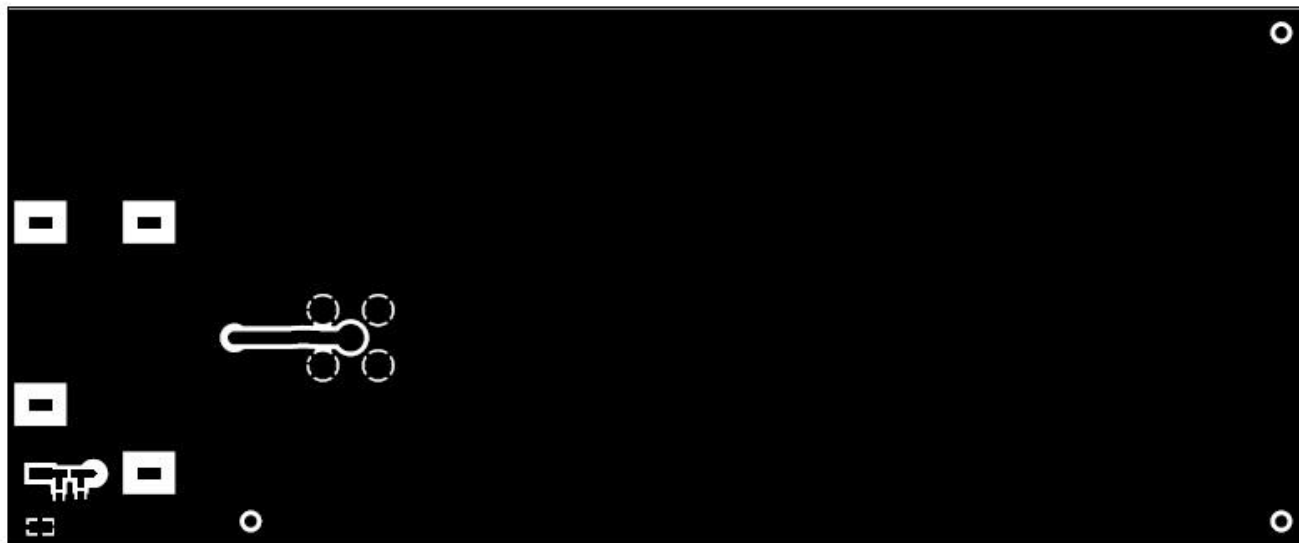

Evaluation board outline

The evaluation board has a matching circuit implemented next to the antenna. This is aimed to enable optimization possibilities for the user. The component positions are sized for 0402 (1005 metric) SMD components.

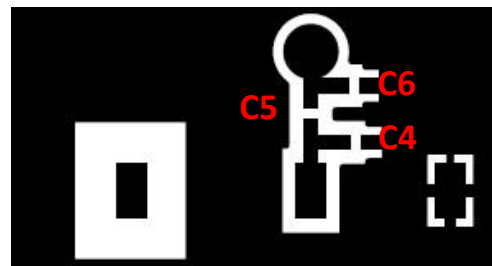
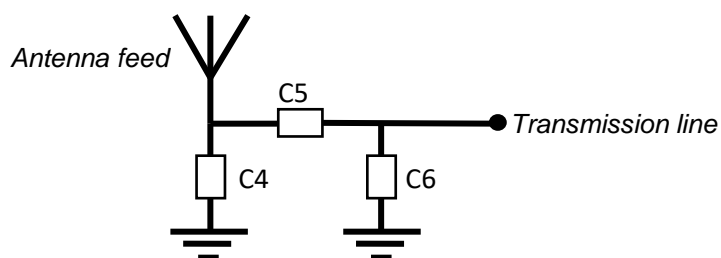

Matching circuit

The antenna needs a matching circuit to adjust the resonant frequency balance. When delivered, the evaluation board is tuned for optimum balance for 860 ~ 870 MHz operation using the following (can be replaced by equivalent):

C4 = N/A

C5 = 5.6 pF (Murata GJM1555C1H5R6WB01)

C6 = 2.2 pF (Murata GJM1555C1H2R2WB01)

However, it is common that the resonant frequency will shift during implementation in an arbitrary device. Therefore, this matching may be changed with other values/components/brands for compensation of such effects. This is further described in General Implementation Guidelines section below.

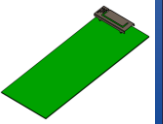

PRO-EB-472

Request Samples



Check Inventory



120.0 x 50.0 mm
RoHS/RoHS II Compliant
MSL Level = 1

General Implementation Guidelines

The antenna can be positioned in different ways, although there are some positions which are more beneficial. Below picture shows a typical PCB with examples on different antenna positions. The optimal position is option 1 or 4.

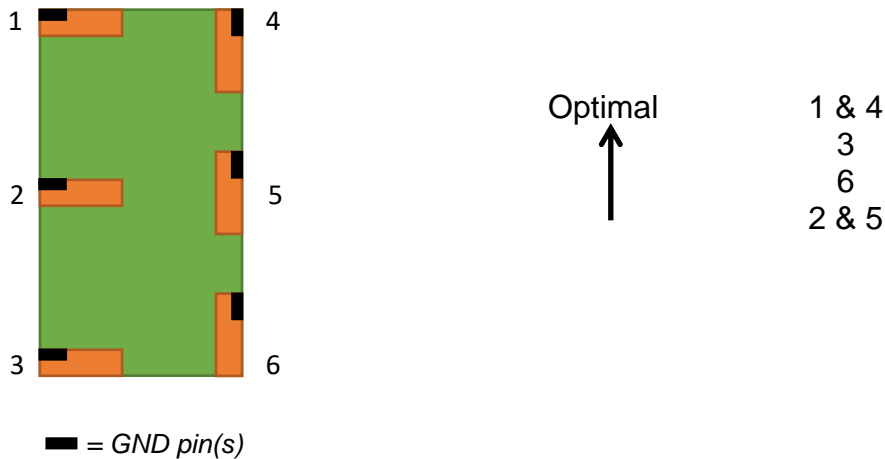

The antenna should be aligned with the PCB edge if possible, preferably with the GND pin(s) close to a corner.

The antenna enables that small electrical components are mounted inside the antenna keep-out block. This is a space-efficient solution which has very little influence on the performance. It may have an impact on the antenna tuning, but is fully possible if there is limited space on the PCB.

Another general aspect on surface mounted antennas is regarding the PCB population. If other electrical components are positioned in the surrounding area of the antenna, some impact on the antenna tuning and radiated performance may be expected. It is recommended that such components are distributed below a topographical slope that starts on PCB level at the antenna keep-out block, and slowly increases the height.

It shall also be highlighted that plastic and metal parts in the near proximity of antennas may influence the antenna tuning and/or performance. This aspect should be noted as a general guideline for all antennas. The effects are difficult to estimate without detailed information, but it is common that a plastic housing above the antenna shifts the resonant frequency down. It is recommended to measure the antenna in the actual device after implementation.

Packaging

1 pcs/box.

ATTENTION: Abracon LLC's products are COTS – Commercial-Off-The-Shelf products; suitable for Commercial, Industrial and, where designated, Automotive Applications. Abracon's products are not specifically designed for Military, Aviation, Aerospace, Life-dependent Medical applications or any application requiring high reliability where component failure could result in loss of life and/or property. For applications requiring high reliability and/or presenting an extreme operating environment, written consent and authorization from Abracon LLC is required. Please contact Abracon LLC for more information.



5101 Hidden Creek Ln Spicewood TX 78669
Phone: 512-371-6159 | Fax: 512-351-8858
For terms and conditions of sales, please visit:
www.abracon.com

REVISED:

ABRACON IS
ISO9001-2015
CERTIFIED

X-ON Electronics

Largest Supplier of Electrical and Electronic Components

Click to view similar products for [Antenna Development Tools](#) category:

Click to view products by [Abracon](#) manufacturer:

Other Similar products are found below :

[PCSD.06.A](#) [1002427-02](#) [1004796-01](#) [YC0010AAEVB](#) [1001013-02](#) [1005454-01](#) [1004795-01](#) [1002436-01](#) [ACR1004A-EVB](#) [RAC00024-EVB](#) [RAC00245-EVB](#) [ACR1004GC-EVB](#) [W3012-K](#) [W3006-K](#) [SPD.25A](#) [74889100TB](#) [A10192-U1](#) [DTAD.01.A.50](#) [SR4C033-EVB-1](#) [AEK-LTE-CER](#) [IOT-K](#) [SR4W035-EVB-1](#) [W3010-K](#) [LORA-K](#) [ISM-K](#) [REFLECTOR-EVB-1](#) [ACAG0201-2450-EVB](#) [ACAG0301-15752450-EVB](#) [ACAG0301-1575-EVB](#) [ACAG0301-24505500-EVB](#) [ACAG0301-5500-EVB](#) [ACAG0801-2450-EVB](#) [ACAG1204-433-EVB](#) [ACAG1204-868-EVB](#) [ACAG1204-915-EVB](#) [ACAR0301-SW2-EVB](#) [ACAR3005-C2WB-EVB](#) [ACAR3005-S824-EVB](#) [ACAR3705-S698-EVB](#) [ACAR4008-S698-EVB](#) [ACR0301U-EVB](#) [ACR1504I3-EVB-A](#) [ACR1504I3-EVB-S](#) [ACR2005I4-EVB](#) [ACR4006X-EVB](#) [PRO-EB-450](#) [PRO-EB-453](#) [PRO-EB-472](#) [PRO-EB-476](#) [PRO-EB-550](#)