

# ACCESSORIES

Frame Size	Fan Series	Plastic Finger Guards Thru Holes	Plastic Finger Guards Barbed Insert	.25" Plastic Filter with Foam Pad	Metal Finger Guard	Plug & Cord Set	Shock & Vibration Mount	Spacer	Mounting Screw Clip	Metal Mesh Filter	Screen	Bracket	Temp Sensor
40 mm	400, 400F, 400J				LZ29-1								
60 mm	600, 600F, 600N, 600NG, 600NV, 620				LZ28								
60 mm	620J				LZ28-1								
80 mm	8200J		LZ32-3		LZ32-4								
80 mm	8000A, 8000N, 8000V, 8100	LZ32-2, LZ32P	LZ32-3	10020-1-5170	LZ22N	LZ120, LZ126	2678-2-2945			LZ60-8			LZ370
80 mm	8300, 8300V		LZ32-3		LZ22N			LZ260	LZ212	LZ60-8			LZ370
80 mm	8400, 8400N, 8400V		LZ32-3		LZ22N			LZ261		LZ60-8			LZ370
92 mm	3000, 3600, 3900	LZ23-2	LZ23-3	10023-1-5170	LZ23	LZ120, LZ126							
92 mm	3300, 3300V	LZ23-2	LZ23-3		LZ23			LZ260	LZ212				LZ370
92 mm	3400, 3400N, 3400NV	LZ23-2	LZ23-3		LZ23			LZ261					LZ370
92 mm	3200J				LZ23-1								
119 mm	4000, 4000AX, 4000N, 4000Z, 4100N, 4200, 4200N, 4400F, 4600N, 4600AX	LZ30-5, LZ30P	LZ30-6	10021-1-5170	LZ30	LZ120, LZ126	2678-2-2945		LZ210	LZ60	LZ40N	LZ40-1	
119 mm	4300, 4300N, 4300V	LZ30-5, LZ30P	LZ30-6		LZ30			LZ260	LZ212				LZ370
119 mm	DV4100	LZ30-5, LZ30P	LZ30-6		LZ30								
119 mm	9900	LZ30-5, LZ30P	LZ30-6	10021-1-5170	LZ30				LZ210	LZ60	LZ40N	LZ40-1	
127 mm	W2G115	88601-2-2929		10024-1-5170	09496-2-4039 50951-2-4039	01433-4-6711 01478-4-6711 01357-4-6711							
127 mm	W2K121			10024-1-5170					LZ210				
127 mm	5200N, DV5200, 5900	LZ33-1	LZ33-2		LZ35								
135 mm	5100N, 5600				LZ25	LZ120, LZ126			LZ210				
150 mm	W2G130				09498-2-4039								
150 mm	W2S130				09498-2-4039 50950-2-4039								
150 mm	7100N, 7200N				LZ24				LZ210				
150 mm	W2E142				03749-2-4039 50950-2-4039	01434-4-6711 01477-4-6711 01505-4-6711							
172 mm	6200N, 6200NT, 6200NTD												
172 mm	6400, DV6400, 6400T				LZ37	LZ120, LZ126			LZ215				
172 mm	DV6200, DV6200TD				LZ38								
172 mm	W2E143				LZ37 (inlet) LZ39 (exhaust)								
172 mm	W2E143				04013-2-4039	01434-4-6711 01477-4-6711 01505-4-6711							
200 mm	W1G180				26386-2-4039								LZ370
225 mm	W1G200T				78128-2-4039								
225 mm	W2E200T				78128-2-4039								
280 mm	W1G250T				09418-2-4039								
280 mm	W2E250T				09418-2-4039								
280 mm	VARIOFAN												LZ370

# Accessories - Metal Finger Guards Tubeaxial Fan

**LZ22N** Series 8000



**LZ25** Series 5100/5600



**LZ28** Series 600



**LZ29-1** Series 400



**LZ23** Series 3000



**LZ26** Series 6000



**LZ30/LZ30F** Series 4000/9000



**LZ24** Series 7000



**LZ27** Series 7000



**09496-2-4039-1** Series W2G115



**78128-2-4039** Series W1G200/W2E200



**26388-2-4039** Series W1G180



**50950-2-4039** Series W2E142



**50952-2-4039** Series W2E143



**50951-2-4039** Series W2G115



## Part Number Changes -

Old Part	New Part
9480-2-4039-1	LZ22N
9483-2-4039-1	LZ23
9497-2-4039-1	LZ30
9497-2-4039-2	LZ30F
9498-2-4039-1	LZ24
92163-2-2929	LZ32P
92165-2-2929	LZ30P

# Accessories - Plastic Finger Guards Tubeaxial Fan

Part Number	Fan series	Dimensions LZ 32..					
		Finger Guards	Mounting	B	C	D	E
LZ32-2	8000	LZ32-2	A 1	3.15 (80)	2.82 (71.5)	.28 (7)	1.34 (34)
LZ32-3	8000	LZ32-3	A 3	3.15 (80)	2.82 (71.5)	.28 (7)	1.34 (34)
LZ32P	8000	LZ32-3	A 3	3.15 (80)	2.82 (71.5)	.28 (7)	1.34 (34)
LZ23-2	3000	LZ23-2	A 1	3.64 (92.5)	3.25 (82.5)	.26 (6.5)	1.81 (46)
LZ23-3	3000	LZ23-3	A 3	3.64 (92.5)	3.25 (82.5)	.26 (6.5)	1.81 (46)
LZ30-5	9000	LZ30-5	A 2	4.69 (119)	4.14 (105)	.26 (6.5)	1.97 (50)
LZ30-6	9000	LZ30-6	A 4	4.69 (119)	4.14 (105)	.26 (6.5)	1.97 (50)
LZ30P	9000	LZ33-1	A 2	5.0 (127)	4.47 (113.5)	.26 (6.5)	1.97 (50)
LZ30-5	4000	LZ33-2	A 4	5.0 (127)	4.47 (113.5)	.26 (6.5)	1.97 (50)
LZ30-6	4000						
LZ30P	4000						
LZ33-1	5200						
LZ33-2	5200						
LZ33-1	5900						
LZ33-2	5900						



### Screw connection



### Barbed inserts



### LZ30P



### LZ32P



Part Number	Series
LZ212	8300
LZ260	8300
LZ261	8400
LZ212	3300
LZ260	3300
LZ210	9000
LZ40N	9000
LZ40-1	9000
LZ60	9000
LZ210	4000
LZ40N	4000
LZ40-1	4000
LZ60	4000
LZ212	4300
LZ260	4300
LZ210	5100
LZ210	5600
LZ210	5200
LZ210	5900
LZ210	7000
LZ370	VARIOFAN

### Filter Kit for 119mm fans

10016-1-5170	Grill Guard
10017-1-5170	Grill Guard and Filter
10018-1-5170	Grill Guard, Filter, Spacer

### LZ 40N / LZ 40-1 / LZ 60

LZ40N of black, fiberglass reinforced plastic with inserted aluminium wire mess LZ60. Mounting with brackets LZ40-1.



### LZ 120

Connecting cable with molded plug. (PVC, black). Stranded wires with multi-core cable ends. For all types of fans with flat pins .12 x .02 in (3.0 x 0.5 mm).



Type	Cable Length in. (mm)	Pins
LZ120	24 (610)	.02 (.5)
LZ126	39.4 (1000)	.02 (.5)

Additional versions are available on special order

### Plug and Cord Sets

.110 x .02 inch (2.8 x .5 mm)

RIGHT ANGLE CONNECTION	
24 inch (610mm)	1434-4-6711-1
36 inch (914mm)	1434-4-6711-3
80 inch (2032mm)	1434-4-6711-80

### LZ 212

Screw clip of rust-resistant spring steel. For mounting fans with threaded pin 3.5 DIN 7970.



### LZ 260 / LZ 261

Spacer of fiberglass reinforced plastic. For screw mounting over both fan and mounting flanges.



### LZ 370

Temperature sensor for speed-controlled fan operation. Temperature range 30...50 C.



Required performance date:

R <sub>25</sub>	= 100 KΩ ±5%
B-value	= 4190 ± 2%
P <sub>max</sub>	= 0,25 W

### LZ 210

Screw clip of hardened steel. For mounting fans with threaded pin 6-32 UNC and/or 3.5 DIN 7970.



### 2678-2-2945

Plastic shock and vibration mount for 119/120 mm fans.





Part Number	Impeller Number	Max. Dimensions (inches)		
		a	b	c
9566-2-4013	133	5.08 (129)	3.43 (87)	0.51 (13)
9588-2-4013	175, 180 & 190	7.28 (185)	5.12 (130)	0.67 (17)
9609-2-4013	220	9.96 (253)	6.10 (155)	0.79 (20)
9597-2-4013	R1G225 R4E225-AR R2E225-BB	8.27 (210)	5.87 (149)	1.10 (28)
9607-2-4013	R4S225 R4E225-AC 250	8.78 (223)	6.57 (167)	0.87 (22)
9614-2-4013	280	10.04 (255)	7.40 (188)	0.98 (25)
9621-2-4013	310	11.81 (300)	7.60 (193)	1.69 (43)
51357-2-4013	355	13.78 (350)	8.90 (226)	2.36 (60)

Part Number	Blower Wheel Size	Max. Dim.- in. (mm)		
		a	b	c
9489-2-4039	085	3.5 (90)	2.9 (74)	3.3 (84)
9485-2-4039	097 ?	-	-	4.5 (114)
9490-2-4039	108	5.0 (126)	4.3 (110)	4.7 (118)
9494-2-4039	120	5.5 (140)	4.9 (124)	5.2 (132)
9500-2-4039	133 ?	-	-	5.7 (145)
9492-2-4039	140/146	6.6 (168)	6.0 (152)	6.2 (158)
9503-2-4039	160	7.1 (180)	6.4 (162)	6.9 (175)
9493-2-4039	180	8.1 (205)	7.2 (183)	7.6 (194)

? – Dual inlet wire guard with three holes at 120°



Material is galvanized wire.

## Technical Note on Scroll Housing

18° EXPANSION, FOR REFERENCE ONLY

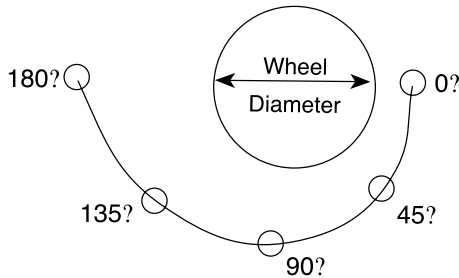

Forward Curved Wheels use 6° - 12° expansion, 10° normal  
Backward Curved Wheel normally uses 18° half scroll  
MODIFY TO SUIT YOUR NEEDS

REFERENCE ONLY BASED ON A 10 INCH DIAMETER WHEEL



ANGLE AROUND WHEEL FROM STARTING POINT  
(a half scroll housing expands for approx. 180 degrees)  
NOTE: Expansion angle must always increase.



# Accessories - Wiring Diagrams and Signals

## Hall Effect Monitor

Selected ebm blowers ordered with this option monitor the speed of the blower with a device consisting of a magnet and solid state switch built into the motor. The output signal is a low voltage DC pulse train that can be incorporated into the end product to trigger an audible or visual alarm or to initiate an orderly system shutdown. This device is suited for telecommunications, computer, peripheral and copier applications, or others as required.

## Hall Effect Monitor for AC Models



Input = 4.5 to 16 VDC;  $T = 60/\text{RPM}$ ;  $V_{out} \approx V_{in}$   
Output Impedance = 4.7 K nominal.

## Hall Effect Monitor for Brushless DC Models



2 pulse / revolution –  $V_{out} \approx 5v$ ; Output current = 5mA max.

## MOTOR WIRING DIAGRAMS

### A. PSC "Type E" Motor

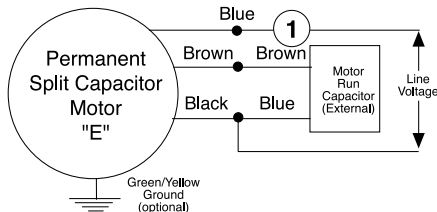

### B. Shaded Pole Motor



① An extra capacitor can be connected in series to yield lower RPM for multi-speed requirements

### C. PSC Motor



### D. PSC Motor



Dotted lines not supplied on all designs

# Accessories - Wiring Diagrams and Signals

## VarioFans have Temperature Dependent Speed Control



## Alarms & Connectors for ebm/Papst Tubeaxial Fans

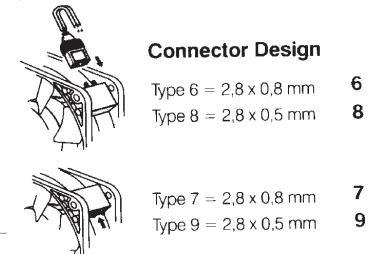
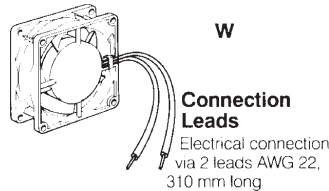
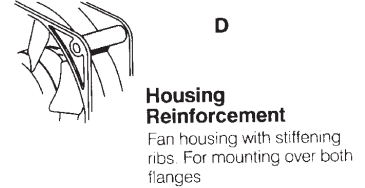
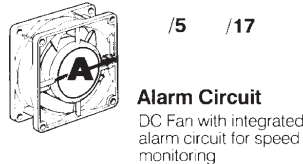
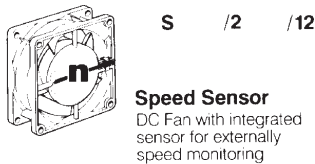

## Characteristics of Fan Signals and Operation with different Alarm Signals

**Speed Sensor Type: S, /2, /12**  
These fans produce speed-proportional square-wave signals via an integrated sensor. This 'electronic' tachometer is used to monitor the fan speed.

**Alarm Signal Type: /10**  
These fans produce a continuous signal output when operating interference-free. When fan speed falls below 75 - 85% of the nominal speed, short low impulses are generated. The greater the fall below the alarm speed, the greater the low impulse width becomes. At rest there is a continuous low signal.

**Alarm Switching Signal Type: /5, /17**  
These fans produce speed-dependent, directly usable high/low square-wave signals via integrated alarm switching circuits.  
/5 models: Switching circuit is galvanically separated with a separate current supply.  
/17: Direct current supply via motor; the switching circuit is not separate.

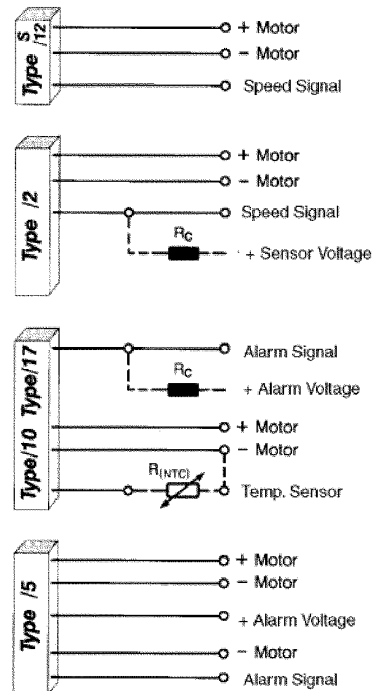

# Accessories - Capacitors

## HOW TO USE CAPACITORS FOR MULTI-SPEED BLOWERS

It is possible to make any ebm blower with a PSC motor a multi-speed blower by adding a second or third capacitor on the load line (blue) at or near the value of the motor run capacitor. Actual capacitor value and RPM achieved are dependent on the nature of each application.

## PLASTIC CAPACITORS

Part Number	Size (mfd)	Temp. Range (°C)	Max. Dim in. (mm)		
			a	b	d
02100-4-7320	1	-25 to +85	1.1 (28)	2.2 (55)	0.5 (12)
99282-4-7320	1.5	-25 to +85	1.1 (28)	2.2 (55)	0.5 (12)
99283-4-7320	2	-25 to +85	1.1 (28)	2.2 (55)	0.5 (12)
02103-4-7320	2.5	-25 to +85	1.1 (28)	2.2 (55)	0.5 (12)
02102-4-7320	3	-25 to +85	1.1 (28)	2.2 (55)	0.5 (12)
99284-4-7320	4	-25 to +85	1.3 (32)	2.2 (55)	0.5 (12)
02101-4-7320	5	-25 to +85	1.4 (36)	2.3 (58)	0.5 (12)
99285-4-7320	6	-25 to +85	1.4 (36)	2.8 (70)	0.5 (12)
99286-4-7320	8	-25 to +85	1.6 (40)	2.6 (67)	0.5 (12)
99287-4-7320	10	-25 to +85	1.6 (40)	2.8 (70)	0.5 (12)

(For larger sizes consult factory)



## METAL CAPACITORS

Part Number	Size (mfd)	Temp. Range (°C)	Max. Dim in. (mm)		
			a	b	c
2151-4-7320	1	-25 to +85	1.0 (25)	2.9 (74)	1.1 (29)
2155-4-7320	1.5	-25 to +85	1.0 (25)	2.9 (74)	1.1 (29)
2156-4-7320	2	-25 to +85	1.0 (25)	2.9 (74)	1.1 (29)
2159-4-7320	2.5	-25 to +85	1.2 (30)	2.8 (71)	1.3 (34)
2160-4-7320	3	-25 to +85	1.2 (30)	3.9 (99)	1.3 (34)
2161-4-7320	4	-25 to +85	1.2 (30)	4.1 (104)	1.3 (34)
2162-4-7320	5	-25 to +85	1.4 (35)	4.1 (104)	1.5 (39)
2163-4-7320	6	-25 to +85	1.4 (35)	4.0 (101)	1.5 (38)
2164-4-7320	7	-25 to +85	1.6 (40)	4.0 (101)	1.7 (43)
2165-4-7320	8	-25 to +85	1.4 (35)	4.0 (101)	1.5 (38)
2166-4-7320	10	-25 to +85	1.4 (35)	3.9 (99)	1.5 (39)
2167-4-7320	12	-25 to +85	1.6 (40)	3.9 (99)	1.7 (43)
2168-4-7320	16	-25 to +75	1.8 (46)	6.3 (160)	1.9 (48)
2169-4-7320	20	-25 to +75	1.8 (46)	6.3 (160)	1.9 (48)
2170-4-7320	25	-25 to +75	1.8 (46)	6.3 (160)	1.9 (48)



# Accessories - Metal Capacitors

with UL, CSA and VDE Approvals

Part Number	Size (mfd)	Temp Range ?C
450-20-0017	1	-20 to +85
450-20-0018	1.5	-20 to +85
450-20-0019	2	-20 to +85
450-20-0020	2.5	-20 to +85
450-20-0021	3	-20 to +85
450-20-0022	4	-20 to +85
450-20-0023	5	-20 to +85
450-20-0024	6	-20 to +85
450-20-0025	7	-20 to +85
450-20-0026	8	-20 to +85
450-20-0027	10	-20 to +85
450-20-0028	12	-20 to +85



LARGER SIZE (see drawing)

Part Number	Size (mfd)	Temp Range ?C
450-20-0029	16	-20 to +85
450-20-0030	20	-20 to +85
450-20-0031	25	-20 to +85
450-20-0033	30	-20 to +85
450-20-0034	40	-20 to +85



Part Number for Boot	710-00-0042
----------------------	-------------

### Boot Dimensions



\* UL File # for capacitors E133000(N)  
 CSA File # for capacitors LR96263  
 UL File # for Boot SA6016(N)

## Accessories - EC Remote Drive And Control Unit

### Part Numbers:

**CHW050-AA01-70**

**CHW050-AA01-71**

### RATINGS:

100-120 VAC, 50/60 Hz, 250 W input  
200-277 VAC, 50/60 Hz, 500 W input  
2.4 A  
Power Factor: >0.98 at 500 W  
Leakage Current: 10 mA  
Maximum ambient temperature: 40° C



### STANDARDS:

UL508C	Power Conversion Equipment file # E208140
EN50081-1	RFI Emissions
EN50082-2	RFI Susceptibility
DIN EN61000-3-2	Harmonics

### Standard features with CHW050-AA01-71:

Digital ebm BUS interface  
Green power ON indicator LED  
Red ALARM indicator LED  
Alarm relay NC  
Alarm relay NO  
Temperature and locked rotor  
protection  
Short circuit protection  
Limited ground fault protection  
Cage clamp connector included

### Additional features with CHW050-AA01-70:

Open collector tach Output (3 pulses/rev.)  
0-10 V external sensor input  
0-10 V control input  
Enable input  
Potentiometers for MIN and MAX settings  
10 VDC / 20 mA stabilized power supply  
18 VDC / 25 mA non-stabilized power supply

### Available Accessories:

25711-2-0199 Application software LISA  
21487-1-0174 Transceiver RS232 / RS485  
25710-1-0174 Repeater RS485

## X-ON Electronics

Largest Supplier of Electrical and Electronic Components

*Click to view similar products for [Fan Accessories](#) category:*

*Click to view products by [ebm papst](#) manufacturer:*

Other Similar products are found below :

[LZ31](#) [LZ32P-1](#) [63070-2-4013](#) [71882-2-4053](#) [73770-2-3634](#) [73806-2-3634](#) [73816-2-3634](#) [854589-1](#) [99485901](#) [99485904](#) [1-21002-3](#) [1247-4-6254](#) [RF119](#) [1434-4-6711-80](#) [1434-4-6711-1](#) [169-002](#) [KM36](#) [27453.32193](#) [27453.32262](#) [99485906](#) [99485912](#) [F92-B](#) [FG92-W2](#) [FK120-30](#) [FK40-30](#) [FK80-45](#) [27453.32241](#) [27453.32298](#) [R88ACPU001M1](#) [R88ACPU001M2](#) [LZ215](#) [LZ22-2](#) [LZ24B](#) [LZ37-2](#) [525-00-0009](#) [KM38](#) [420-05-0276](#) [50824-4-1040](#) [04.846.1353.0](#) [04.846.1453.0](#) [055032](#) [07100-40](#) [07190-50](#) [08195](#) [08245](#) [09325-M/60](#) [09494-2-4039](#) [09576-2-4013](#) [109-1102](#) [109-019H](#)