



PCR sensor A111 EVK hardware user guide

- XR112, XC112, LH112



PCR sensor A111 EVK hardware user guide

- XR112, XC112, LH112

Author: Acconeer

Version 1.5: 2022-08-25

Acconeer AB



Table of Contents

1.	Overview of the XC112/XR112 Evaluation Kit.....	4
1.1	Introduction	4
1.2	Getting Started.....	4
2.	Software for the EVK.....	5
2.1	SW download	5
2.2	SW API Description.....	5
3.	The EVK Hardware.....	6
3.1	XC112 Connector Board.....	7
3.1.1	Overview	7
3.1.2	Power.....	8
3.1.3	Electrical Schematics.....	9
3.1.4	Bill of Material	14
3.1.5	Pinning.....	14
3.2	XR112 Sensor Board.....	16
3.2.1	Overview	16
3.2.2	Electrical Schematics.....	17
3.2.3	Bill of Material	20
3.2.4	Pinning.....	20
3.3	Lens Evaluation Kit LH112.....	22
3.3.1	Overview	22
3.3.2	Contents and assembly	22
3.3.3	Performance.....	24
4	Design considerations.....	25
5	Safety.....	26
5.1	Electrostatic precautions.....	26
6	Regulatory Information	27
7	Revision History.....	28
8	Disclaimer	29



1. Overview of the XC112/XR112 Evaluation Kit

1.1 Introduction

The XC112/XR112 Evaluation Kit (The EVK) is a development platform featuring Acconeer's A111. This is an optimized low-power, high-precision 60 GHz radar in one package solution with integrated Baseband, RF front-end and Antenna.

The A111 is based on pulsed coherent radar technology (PCR). It has leading-edge patented sensor technology with pico-second time resolution. The A111 sets a new benchmark as far as power consumption and distance accuracy are concerned and it comes fully integrated in a small package of 29 mm².

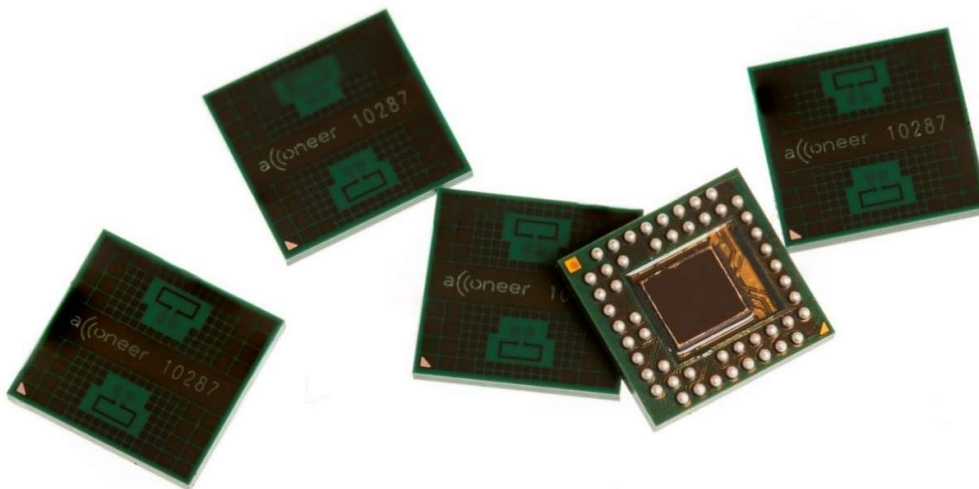

The A111 can measure absolute distance with mm accuracy up to a range of 2m with a continuous sweep update frequency of up to 1500 Hz.

The A111, 60 GHz radar is not compromised by any natural source of interference such as noise, dust, color, direct or indirect light.

The EVK consists of

- 1 XC112 connector board with the possibility to connect up to four radar sensor boards.
- 1 XR112 which is Acconeer's sensor board featuring A111. A 400mm long FFC for connecting XC112 and XR112 is included with the XR112 as of February 1st, 2019. For XR112 sold before this date, a 203.2mm long FFC, Molex 15020-0175 was included with the XR112.

The EVK does not contain any processor or micro controller. It is designed for use with a Raspberry Pi 3.

1.2 Getting Started

A Quick Installation Guide is available at <https://youtu.be/VLswgP2HFJg>

This short instruction video will ensure a smooth setup and installation. For more information on retrieving the Acconeer SW, please refer to the next chapter.



2. Software for the EVK

2.1 SW download

The SW is available for downloading at <https://www.acconeer.com/products>

2.2 SW API Description

The Acconeer SW comes with an API (Application Programming Interface). Acconeer provides several service oriented example applications, as well as customer guidelines for application development when utilizing the API. All APIs provided by Acconeer are documented.

Open the SW zip file downloaded from Acconeer's download site. In the file structure, please locate /doc.

doc/ contains API documentation in HTML format – simply open doc/html/index.html.



3. The EVK Hardware

Figure 1 shows the block diagram for the EVK

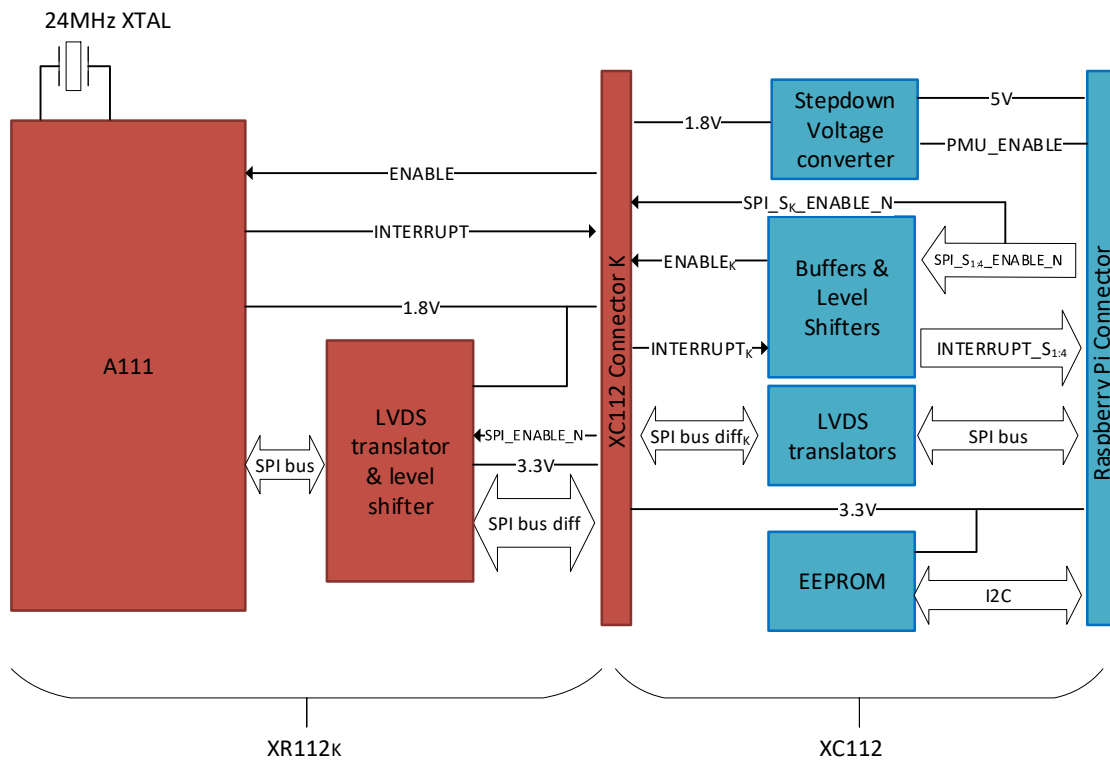

K=Sensor Board Number, 1-4

Figure 1 The EVK block diagram.



3.1 XC112 Connector Board

The XC112 is Acconeer's connector board and part of the EVK.

3.1.1 Overview

Picture 1 shows the XC112 connector board, front side with a Raspberry Pi connected.

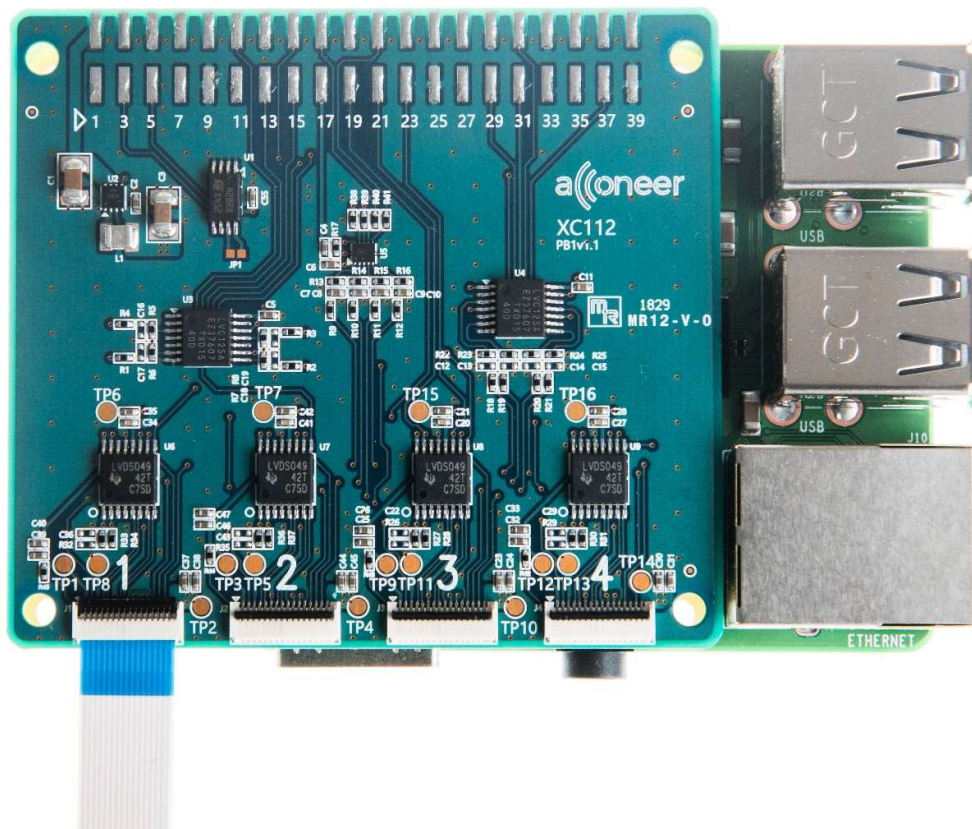



Picture 2 shows the reverse side of the XC112.

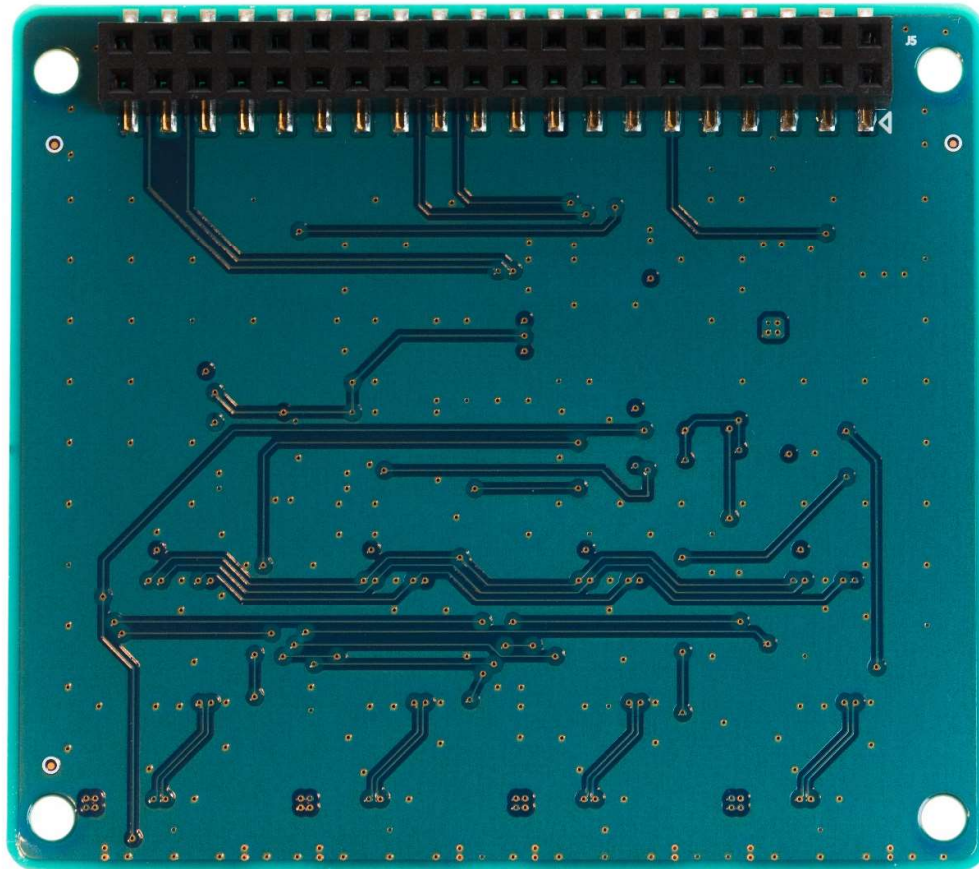

3.1.2 Power

The Evaluation Kit is powered through the Raspberry Pi. When the power LED on the Raspberry Pi is lit, the connector board is powered on and ready for use.



3.1.3 Electrical Schematics

On the following pages, please find the electrical schematics for the XC112.

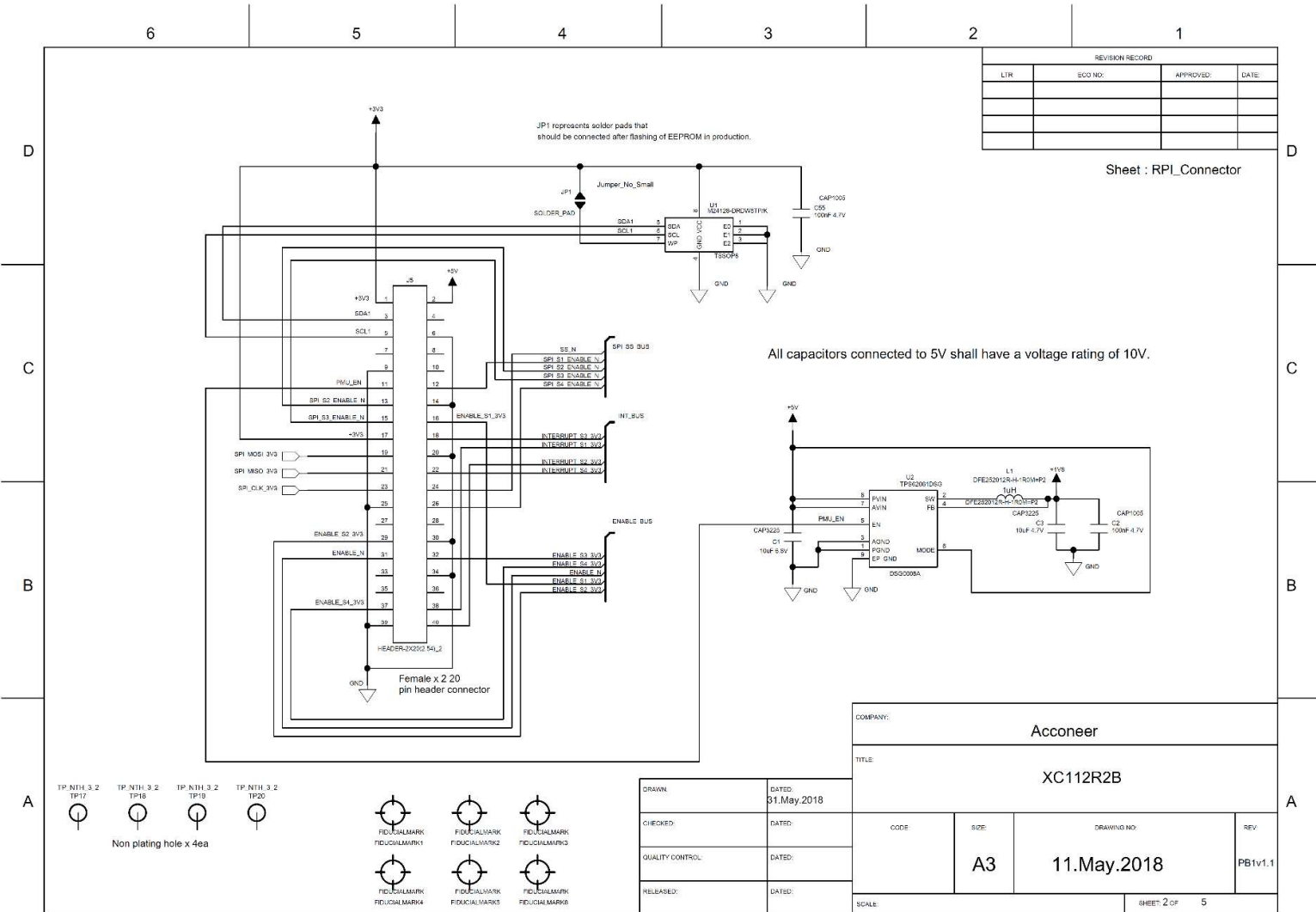

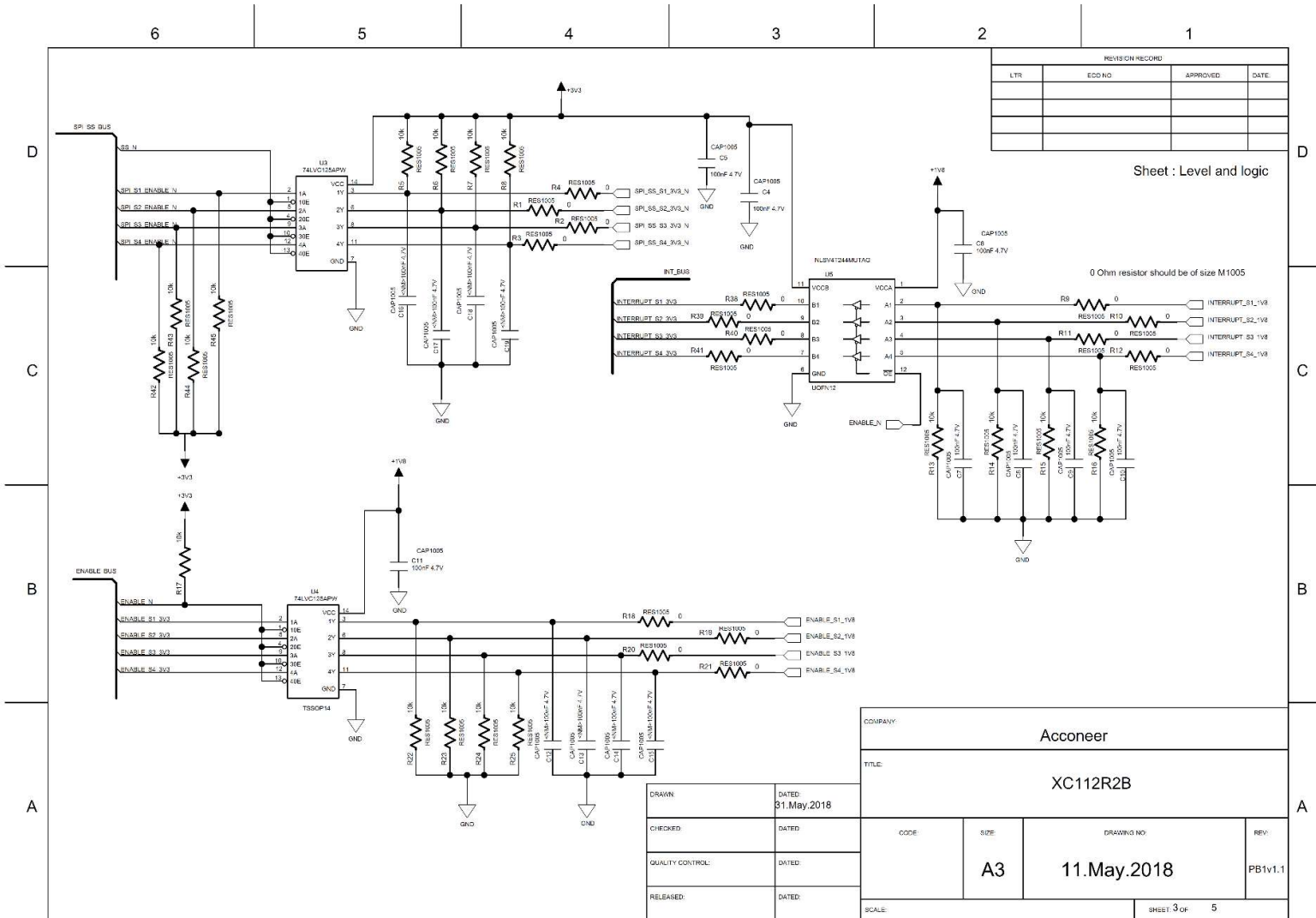

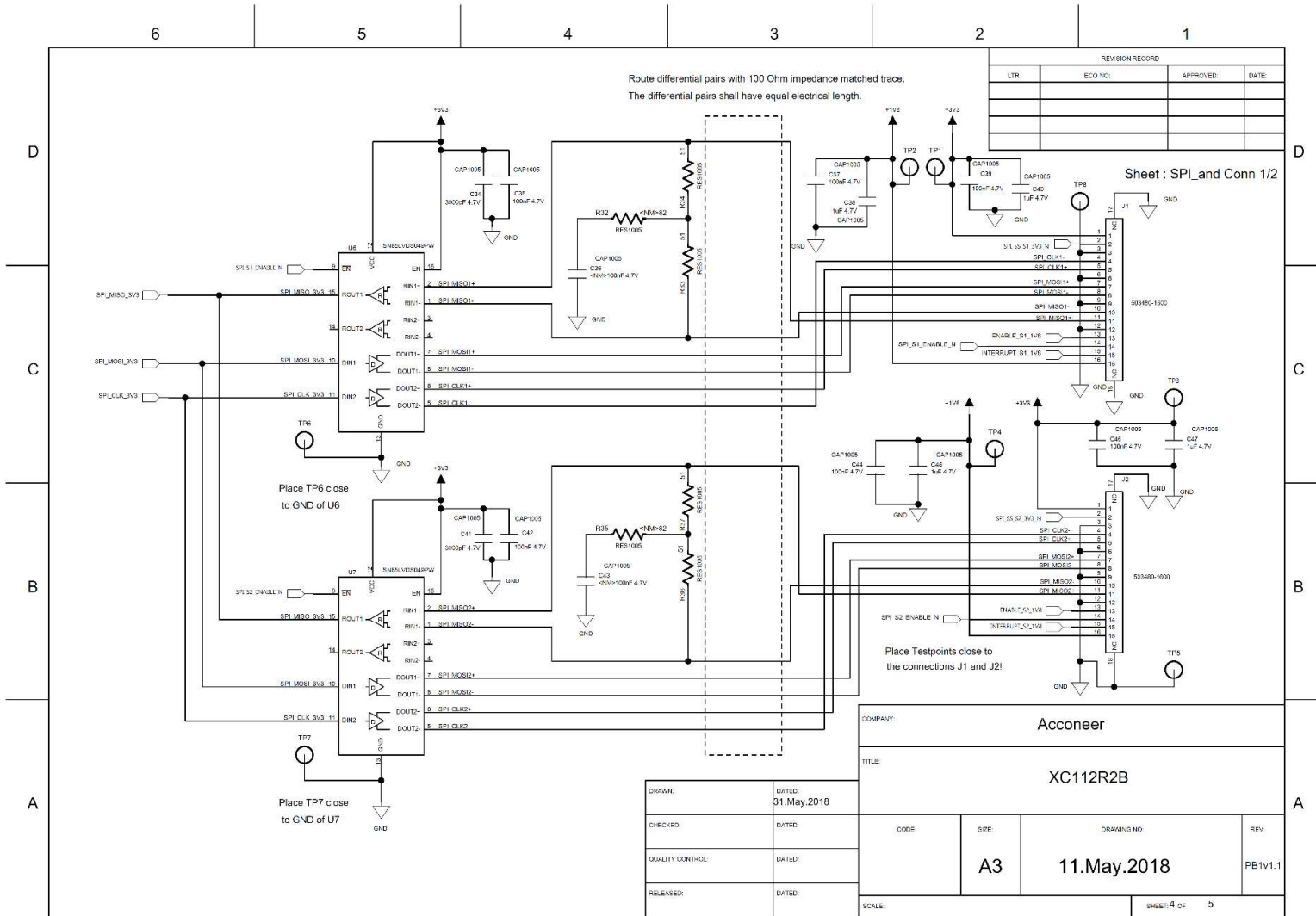



3.1.4 Bill of Material

Table 1 shows the BOM for the XC112

Table 1 The BOM for the XC112.

Component ref.	Part Number	QTY	Value	Comment
C1, C3	10/UF/K/X5R/50V/3216	2	10uF	
C10, C11, C2, C21, C23, C25, C28, C31, C33, C35, C37, C39, C4, C42, C44, C46, C5, C55, C6, C7, C8, C9	100/NF/J/50V/X5R/1005	22	100nF	
C20, C27, C34, C41	3.9/NF/K/50V/X7R/1005	4	3900pF	
C24, C26, C30, C32, C38, C40, C45, C47	1/UF/K/10V/X5R/1005	8	1uF	
L1	MURATA, DFE252012R-H- 1R0M=P2	1	1uH	
J1, J2, J3, J4	Molex 503480-1600	4		16Pin 0.5 FPCB CONN BACKFLIP
J5	CNC, JINLIN, FH254- 40DSMT/2.54MM 2*20 SMD	1		
R1, R10, R11, R12, R18, R19, R2, R20, R21, R3, R38, R39, R4, R40, R41, R9	0/OHM/J/1005	16	0Ohm	
R13, R14, R15, R16, R17, R22, R23, R24, R25, R5, R6, R7, R8, R42, R43, R44, R45	10/KOHM/F/1005	17	10kOhm	
R27, R28, R30, R31, R33, R34, R36, R37	51/OHM/J/1005	8	51Ohm	
U1	M24128-DRDW8TP/K	1		
U2	TPS62061DSGR	1		
U3, U4	74LVC125APW	2		
U5	NLSV4T244MUTAG	1		
U6, U7, U8, U9	SN65LVDS049PW	4		

3.1.5 Pinning

Table 2 shows the pinout of the XC112 Raspberry Pi connector J5.



Table 2 The pinout of the XC112 Raspberry Pi connector.

Pin Number	Description
1	+3.3V
2	+5V
3	SDA1 connected to EEPROM
4	Not connected
5	SCL1 connected to EEPROM
6	GND
7	Not connected
8	Not connected
9	GND
10	Not connected
11	PMU_EN
12	SPI_S1_ENABLE_N, selects sensor 1 to respond to SS_N.
13	SPI_S2_ENABLE_N, selects sensor 2 to respond to SS_N.
14	GND
15	SPI_S3_ENABLE_N, selects sensor 3 to respond to SS_N.
16	ENABLE_S1_3V3, selects sensor 1 to respond to ENABLE_N.
17	+3.3V
18	INTERRUPT_S3_3V3, interrupt from sensor 3.
19	SPI_MOSI_3V3
20	GND
21	SPI_MISO_3V3
22	INTERRUPT_S4_3V3, interrupt from sensor 4.
23	SPI_CLK_3V3
24	SS_N, SPI slave select signal.
25	GND
26	SPI_S4_ENABLE_N, selects sensor 4 to respond to ENABLE_N.
27	Not connected
28	Not connected
29	ENABLE_S2_3V3, selects sensor 2 to respond to ENABLE_N.
30	GND
31	ENABLE_N, sensor enable signal.
32	ENABLE_S3_3V3, selects sensor 3 to respond to ENABLE_N.



Pin Number	Description
33	Not connected
34	GND
35	Not connected
36	Not connected
37	ENABLE_S4_3V3, selects sensor 4 to respond to ENABLE_N.
38	INTERRUPT_S1_3V3, interrupt from sensor 1.
39	GND
40	INTERRUPT_S2_3V3, interrupt from sensor 2.

3.2 XR112 Sensor Board

3.2.1 Overview

Picture 3 shows the XR112. The leftmost picture shows the front side of the XR112, with the A111 mounted centrally, and the rightmost picture shows the reverse side of the XR112.

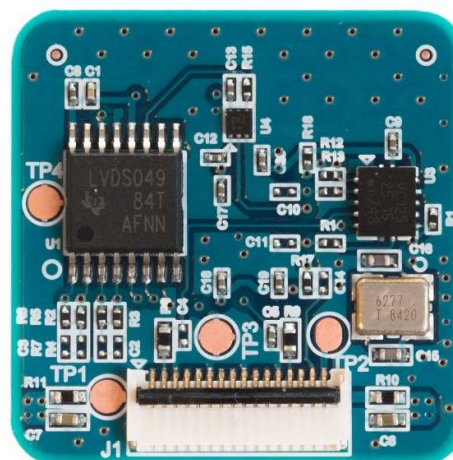



3.2.2 Electrical Schematics

Please find the electrical schematics of the XR112 below.

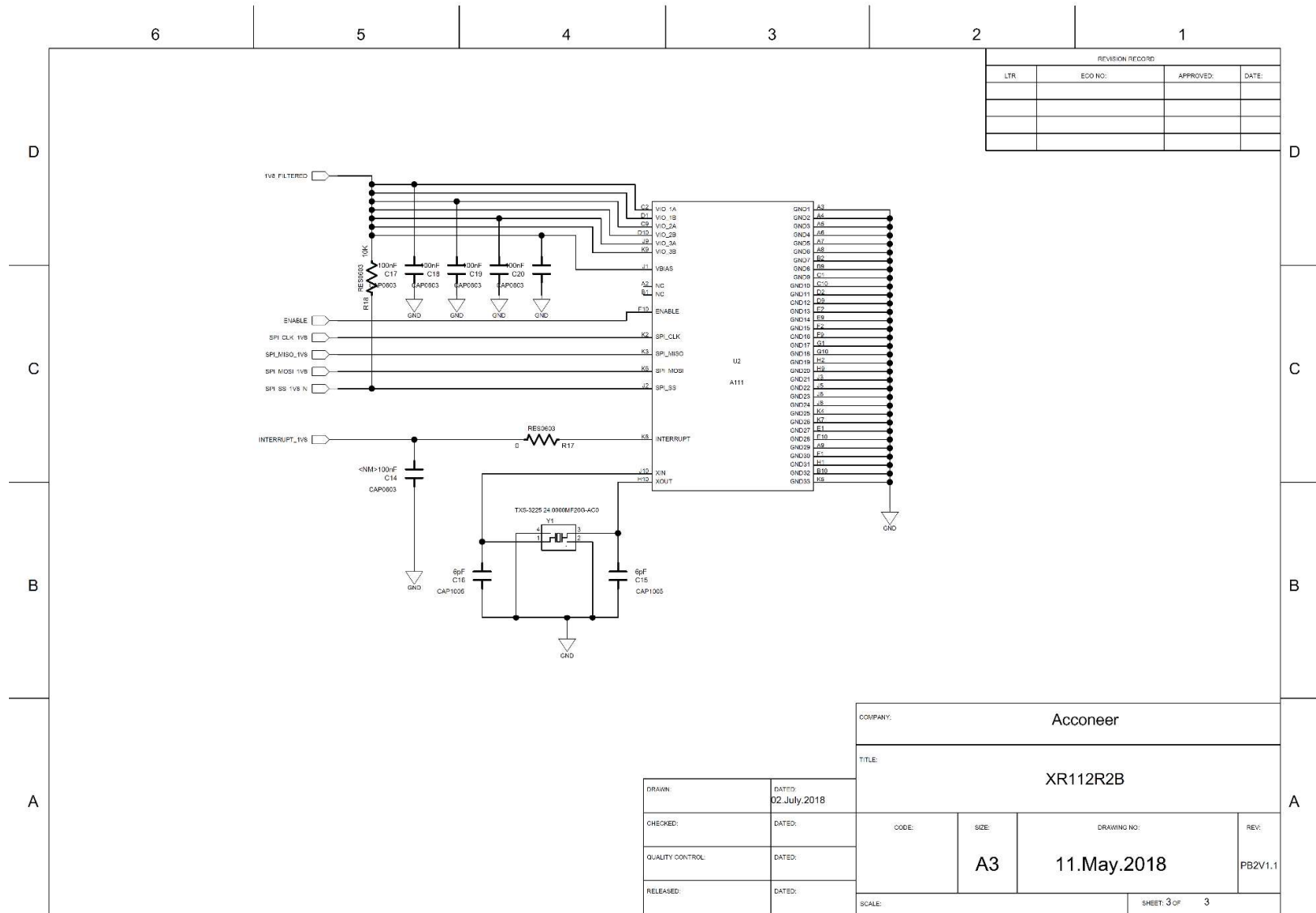

REVISION RECORD			
LTR	ECO NO.	APPROVED:	DATE:

COMPANY: Acconeer			
TITLE: XR112R2B			
DRAWN:	DATED: 02.July.2018	CODE:	SIZE: A3
CHECKED:	DATED:	DRAWING NO: 11.May.2018	REV: PB2V1.1
QUALITY CONTROL:	DATED:	SCALE:	SHEET: 3 OF 3
RELEASED:	DATED:		



3.2.3 Bill of Material

Table 3 shows the BOM for the XR112.

Table 3 The BOM for XR112

Component Ref.	Part Number	QTY	Value	Comment
C1	3.9/NF/K/10V/X5R/0603	1	3900pF	
C12, C13, C17, C18, C19, C20, C5, C8, C9	100/NF/K/6.3V/X5R/0603	9	100nF	
C6, C7	1/UF/K/10V/X5R/1005	2	1uF	
C15, C16	6/PF/C/50V/C0G/1005	2	6pF	
J1	503480-1600	1		16Pin 0.5 FPCB CONN BACKFLIP
R1, R12, R18	10/KOHM/J/0603	3	10kOhm	
R2, R3, R5, R6	51/OHM/F,J/0603	4	50Ohm	
R8, R9, R10, R11	0/OHM/J/1005	4	0Ohm	
R13, R14, R17	0/OHM/J/0603	3	0Ohm	
R15	100/OHM/J/0603	1	100Ohm	
U1	SN65LVDS049PW	1		
U2	A111R2C	1		
U3	74LVC125ABQ	1		
U4	74AUP1T34GF	1		
Y1	EPSON, TSX-3225 24.0000MF20G-AC0	1		24MHz

3.2.4 Pinning

Table 4 shows the pinout of the XC112 connector J1.

Table 4 The pinout of the XC112 connector J1.

Pin Number	Description
1	+3.3V
2	SPI_SS 3V3_N, SPI slave select.
3	GND
4	SPI_CLK-
5	SPI_CLK+
6	GND
7	SPI_MOSI+
8	SPI_MOSI-
9	GND



Pin Number	Description
10	SPI_MISO-
11	SPI_MISO+
12	GND
13	ENABLE_1V8, Sensor Enable.
14	SPI_ENABLE_N, Enable signal for differential converter IC.
15	INTERRUPT_1V8, Interrupt from the Sensor.
16	1.8V



3.3 Lens Evaluation Kit LH112

3.3.1 Overview

The LH112 lens evaluation kit is an accessory for the XR112/XC112 evaluation kit. The lenses can be used to increase sensor performance. The lenses increase signal strength by focusing the beam width of the radiated EM-waves and thereby concentrating the emitted power. The lens kit is sold separately from XR112 and XC112.

3.3.2 Contents and assembly

The LH112 lens kit is delivered including 4 parts. The included items are (as shown in picture below):

1. Lens and PCB holder
2. HBL Lens (Hyperbolic Lens)
3. FZP Lens (Fresnel Zone Plate)
4. Flat cover

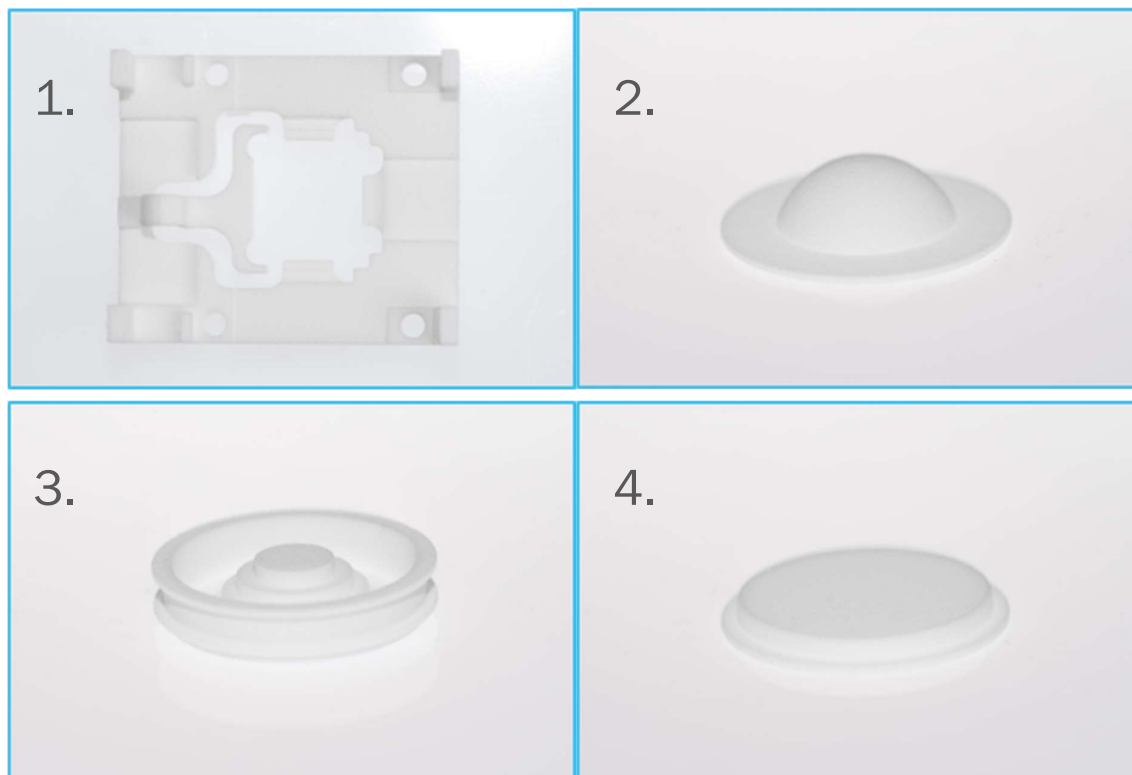

The XR112 can be mounted directly to the lens and PCB holder. Make sure that the sensor is mounted correctly as the exact sensor position in relation to the lens is important for optimal performance.

The pictures below show XR112 mounted in the PCB holder from below and above:

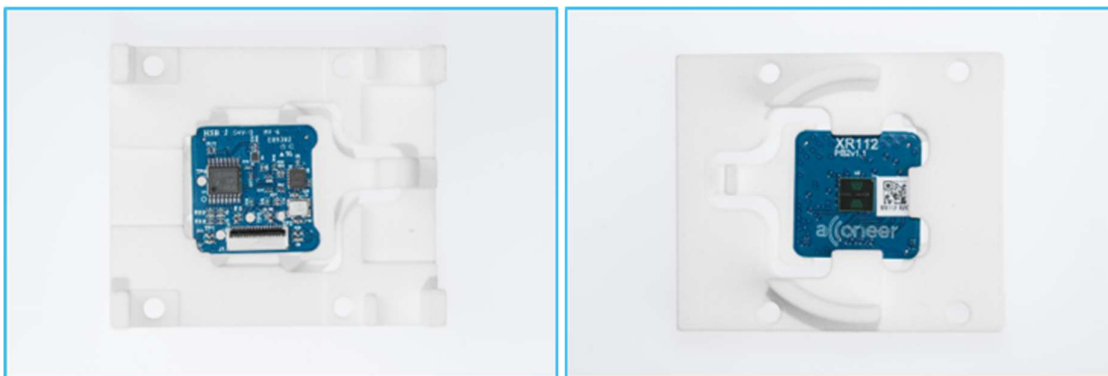

Both lenses can be fitted in the holder in two different positions, D1 or D2. The cover is only used in the D1 position. The two positions will give you slightly different performance. Performance results can be found in the next section. The pictures below show the difference between positions D1 and D2:

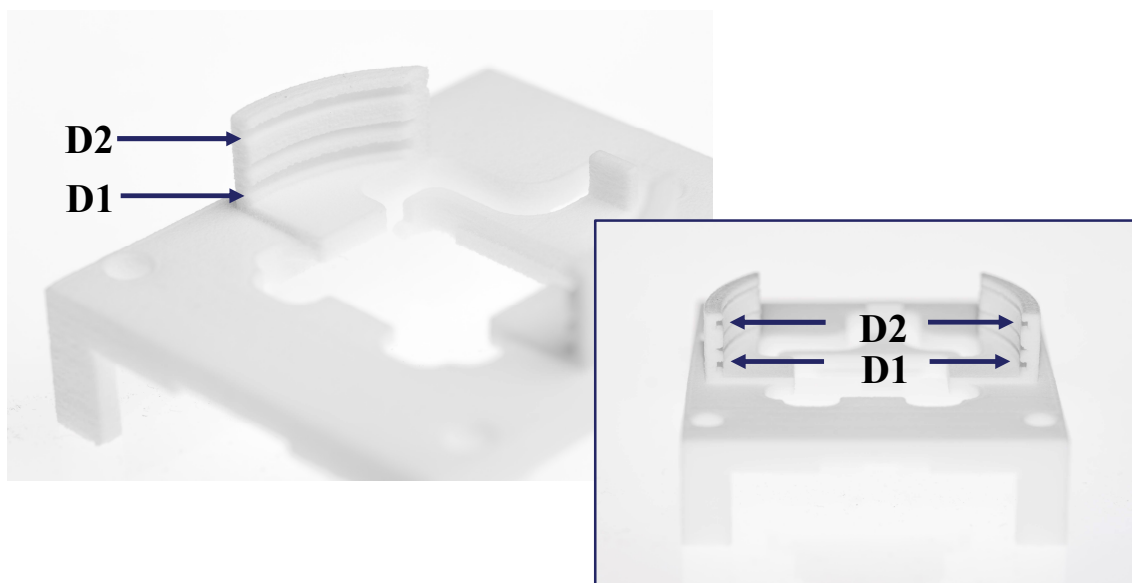



3.3.3 Performance

The transmitted electromagnetic waves from the Acconeer sensor has different divergence for the E-plane and H-plane. When mounted in front of the sensor the lenses affect the signal strength as well as the spread of the signal.

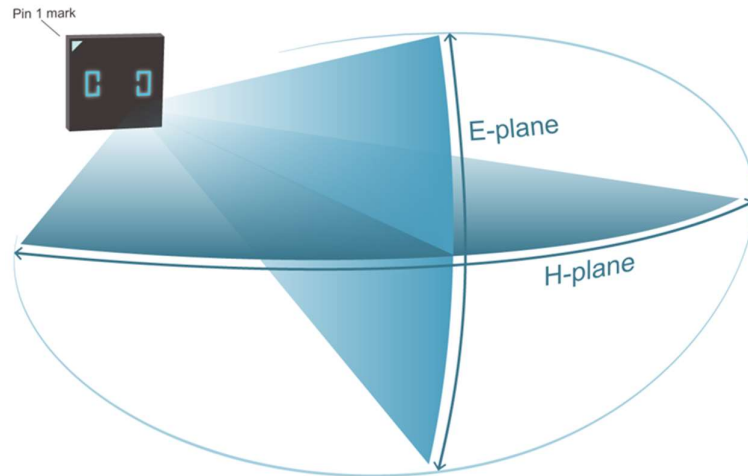

The expected performance for maximum gain and half power beam width (HPBW) can be found in the table below.

	Max Gain. (dB _{FS})		HPBW-E (degree)		HPBW-H (degree)	
Free Space	0		40		63	
Cover	-0.15		40		63	
Lens Position	D1	D2	D1	D2	D1	D2
HBL	5.4	9.5	15	12	20	12
FZP	5.6	8.5	25	12	12	10

* The dB_{FS} gain is the radar loop gain (Tx + Rx gain) relative to a free-space measurement.



4 Design considerations

The EVK was designed for sensor evaluation purposes only. Should you want to design a product, it is strongly recommended to carefully read and follow the A111 data sheet. The Evaluation Kit is not optimized for product development.



5 Safety

5.1 Electrostatic precautions



Please take electrostatic precautions, including using ground straps, when using the EVK or any of its components. An electrostatic discharge could damage the device.



6 Regulatory Information

Acconeer have no plans to certify the XC112/XR112 EVK, it is only for evaluation purposes.
Regulatory Compliance for A111, refer to A111 datasheet.



7 Revision History

Date	Revision	Changes
2018-08-14	1.0	Original version
2019-02-04	1.1	Updated information about FFC in chapter 1.1.
2019-11-25	1.2	Added information regarding LH112
2021-04-21	1.3	ISO 14001 updates
2021-10-04	1.4	
2022-08-25	1.5	Updated chapter "Regulatory Information".



8 Disclaimer

The information herein is believed to be correct as of the date issued. Acconeer AB (“**Acconeer**”) will not be responsible for damages of any nature resulting from the use or reliance upon the information contained herein. Acconeer makes no warranties, expressed or implied, of merchantability or fitness for a particular purpose or course of performance or usage of trade. Therefore, it is the user’s responsibility to thoroughly test the product in their particular application to determine its performance, efficacy and safety. Users should obtain the latest relevant information before placing orders.

Unless Acconeer has explicitly designated an individual Acconeer product as meeting the requirement of a particular industry standard, Acconeer is not responsible for any failure to meet such industry standard requirements.

Unless explicitly stated herein this document Acconeer has not performed any regulatory conformity test. It is the user’s responsibility to assure that necessary regulatory conditions are met and approvals have been obtained when using the product. Regardless of whether the product has passed any conformity test, this document does not constitute any regulatory approval of the user’s product or application using Acconeer’s product.

Nothing contained herein is to be considered as permission or a recommendation to infringe any patent or any other intellectual property right. No license, express or implied, to any intellectual property right is granted by Acconeer herein.

Acconeer reserves the right to at any time correct, change, amend, enhance, modify, and improve this document and/or Acconeer products without notice.

This document supersedes and replaces all information supplied prior to the publication hereof.



Acconeer AB
IDEON Gateway
Scheelevägen 27
223 63 LUND
Sweden

www.acconeer.com
info@acconeer.com
+46 10 218 92 00

X-ON Electronics

Largest Supplier of Electrical and Electronic Components

Click to view similar products for [Modules Accessories](#) category:

Click to view products by [Acconeer](#) manufacturer:

Other Similar products are found below :

[7010-0001](#) [SI-HDMI-EDID-EM](#) [AXXSTCPUCAR](#) [AXXRMFBU5](#) [HFT for mounting KIT FN928X_FN929X](#) [BKCMCR1ABB](#)
[98R3612003E](#) [106897](#) [40222R](#) [4D ARDUINO ADAPTOR SHIELD II](#) [850-10953-2AC](#) [850-13086](#) [1960073820N001](#) [2037609](#)
[20926110901](#) [2400014](#) [DC-ES-BKT](#) [PYCASE GREEN](#) [PYCASE BLUE](#) [FP15072_ZORYA-SC-HEKLA](#) [20953000007](#) [AIMB-B2000-15ZE](#)
[2400078](#) [2000005670](#) [ASMB-FF20F-02A1E](#) [70703](#) [RK-610AM,Black](#) [AX93299](#) [AX93292](#) [BS-RB10005](#) [PCM-110-00A3E](#) [RAM-](#)
[MOUNT-07E](#) [HPC-7242MB-00XE](#) [ASMB-FF3PX-12A1E](#) [AMK-V004E](#) [AIMB-RP10P-01A1E](#) [96OT-MT-6901EB](#) [96KBM-1C](#)
[1652004519](#) [70761](#) [70702](#) [DP-HDMI-R10](#) [PAC-700GB-R11/A618A](#) [575-BBIS](#) [RACK-220GW/A130B](#) [850-33100](#) [492-BBKM](#) [70760](#)
[PICONYMPHGL](#) [106896](#)