

# EA4529YH-T1011 User's Guide

## USB Car Charger Solution

### Description

This document describes the characteristic and operation of the Active Semi **EA4529YH-T1011** evaluation kit (EVK). It provides setup and operation instructions, schematic, layout, BOM, and test data. This EVK demonstrates the ACT4529YH-T1011 version of the IC. Other ACT4529YH-Txxxx versions, including automotive versions, can be evaluated on this EVK by replacing the IC and any other necessary components.

EVK OPN	PDC	USB AUTO DETECT	QC2.0	CERTIFICATION
EA4529YH-T0001	Yes	YES	No	MFi
EA4529YH-T0010	Yes	No	Yes	QC2.0
EA4529YH-T0011	Yes	Yes	Yes	N/A
EA4529YH-T1011	Yes	Yes	Yes	N/A
EA4529MYH-T0010	Yes	No	Yes	SAE J1752 M8A /QC2.0
EA4529MYH-T1011	Yes	Yes	Yes	SAE J1752 M8A

### Features

The EVK is a QC2.0 car charger solution. The EVK contains the high efficiency step-down DC/DC converter that operates in either CV (Constant Output Voltage) mode or CC (Constant Output Current) mode. The EVK provides up to 2.4A output current at 125kHz switching frequency. It operates from  $V_{in} = 6V$  to 32V and provides an output voltage of 5V, 9V, or 12V depending on the load's requested voltage. Gerber files are available to minimize time-to-market for applications that want to use the EVK as an end product.

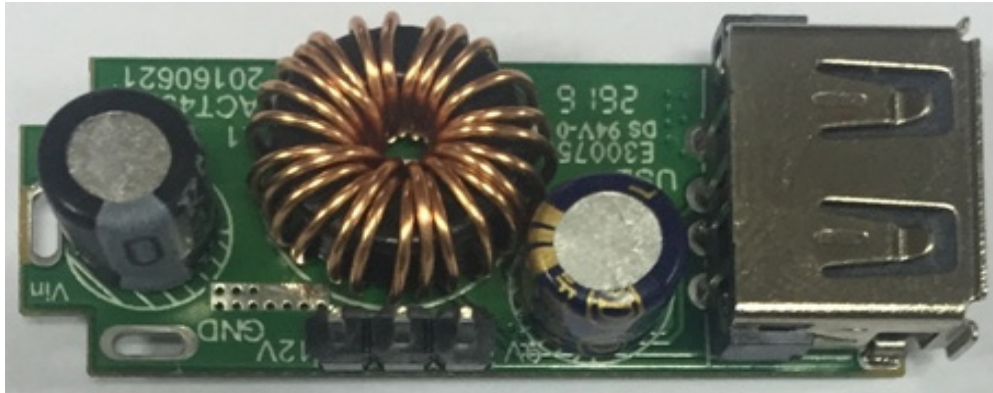

Figure 1 – EVK Picture - Top

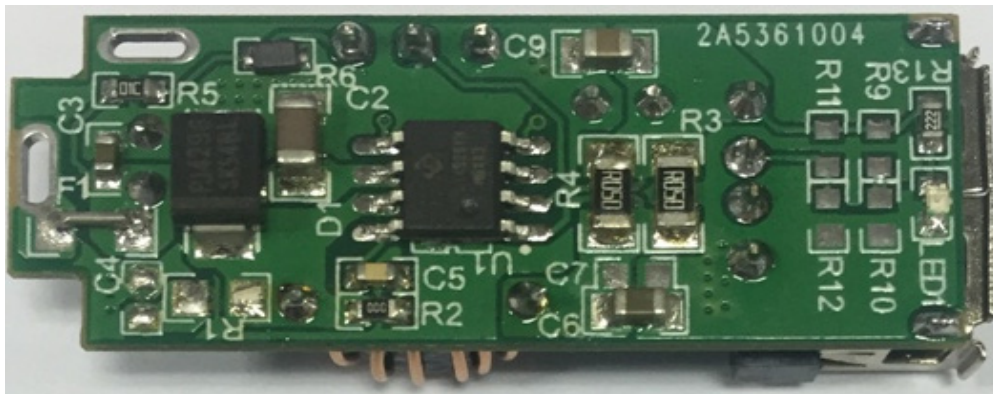

Figure 2 – EVK Picture - Bottom

## Setup

### Required Equipment

EA4529YH-T1011 EVK

Power supply – 40V @ 4A for full power operation

Oscilloscope – >100MHz, >2 channels

Loads –Electronic/resistive load with 3.5A minimum current capability.

Digital Multimeters (DMM)

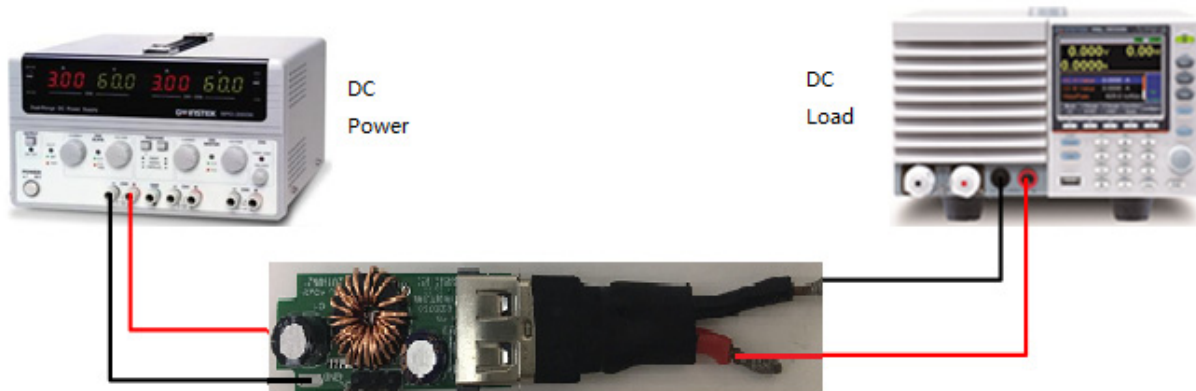

Figure 3 – EVK Setup

## Hardware Setup

1. Connect a DC Power to the Vin and GND on the left side of the EVK.
2. Using a USB connector, connect the EVK output to an electronic load.
3. Recommended Operating Conditions

Table 1. Recommended Operating Conditions

Parameter	Description	Min	Typ	Max	Unit
VIN	All buck input voltages	10	12	36	V
IOUT	Maximum load current		2.4		A

## EVK Operation

### Turn on

Apply the 12V input voltage. LED1 turn on to indicate that the buck converter is operational.

### PCB Layout

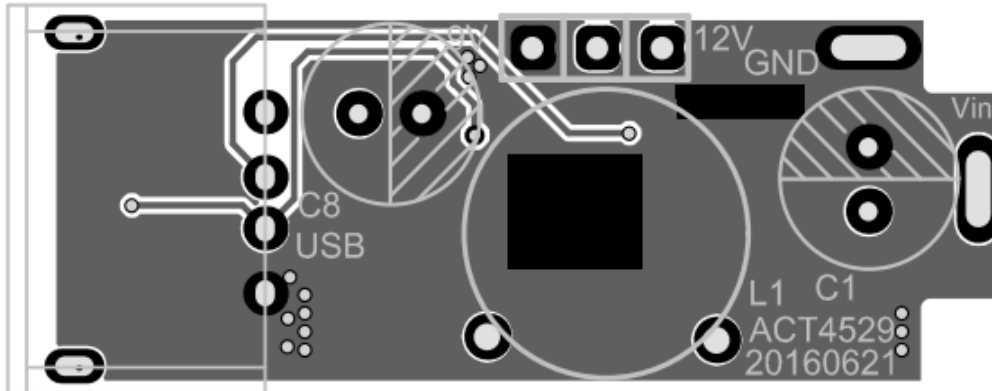

Top Layer

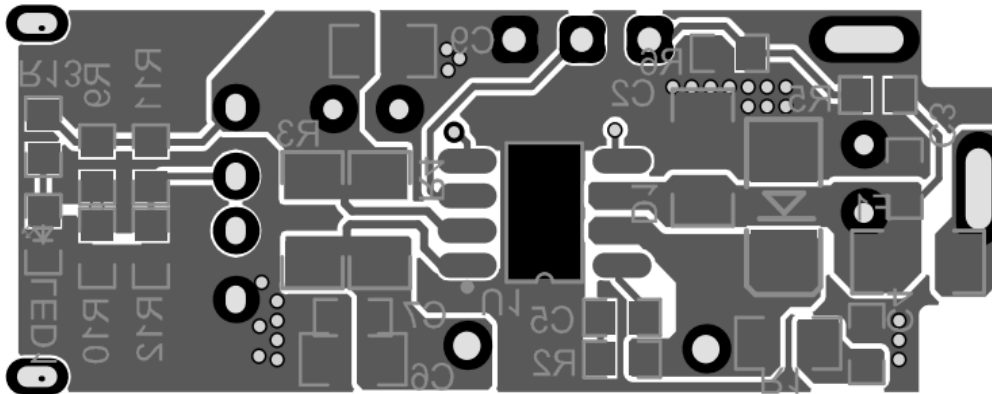

Bottom Layer

---

## Test Results

### Output Regulation

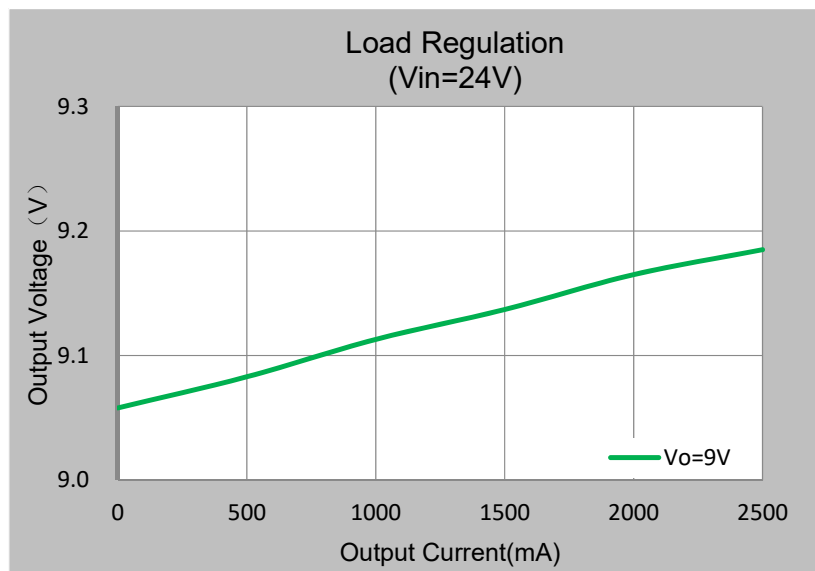
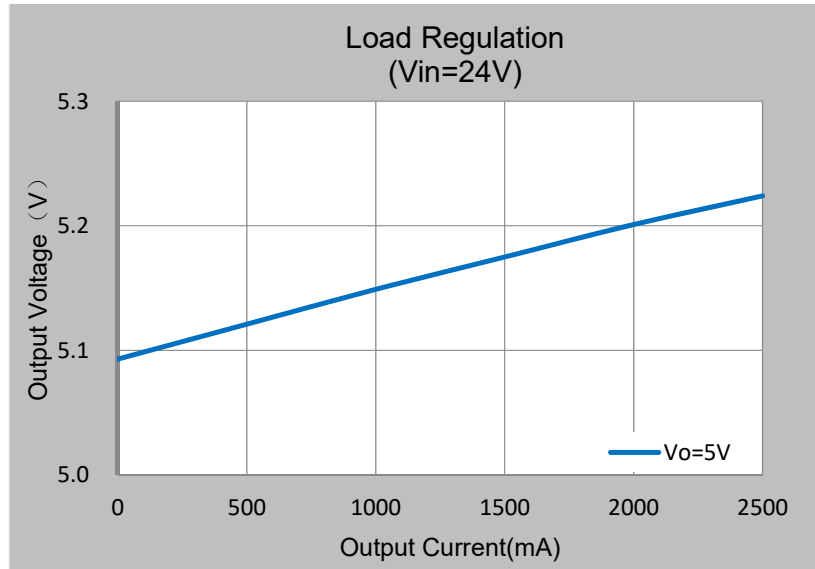

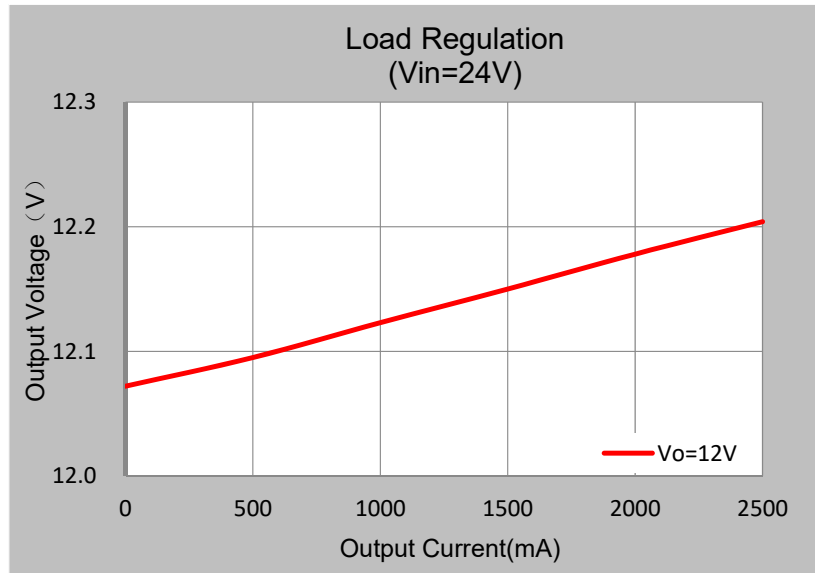

**Efficiency ( $T_a=25^{\circ}C$ )**

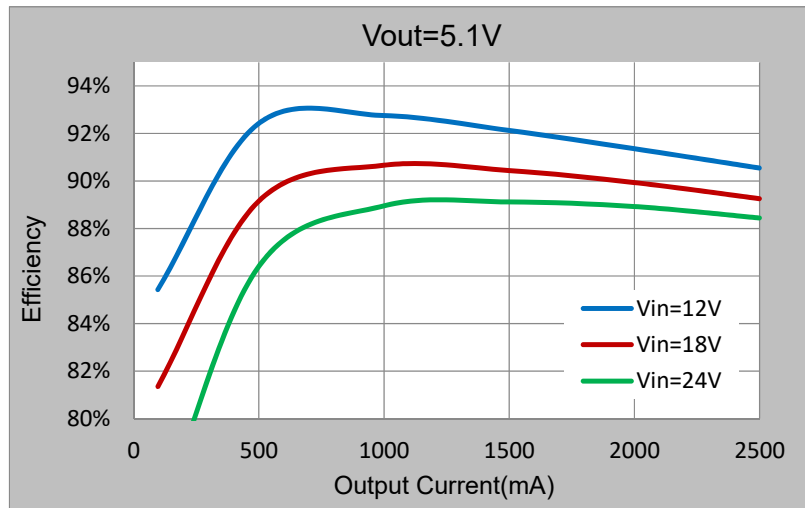

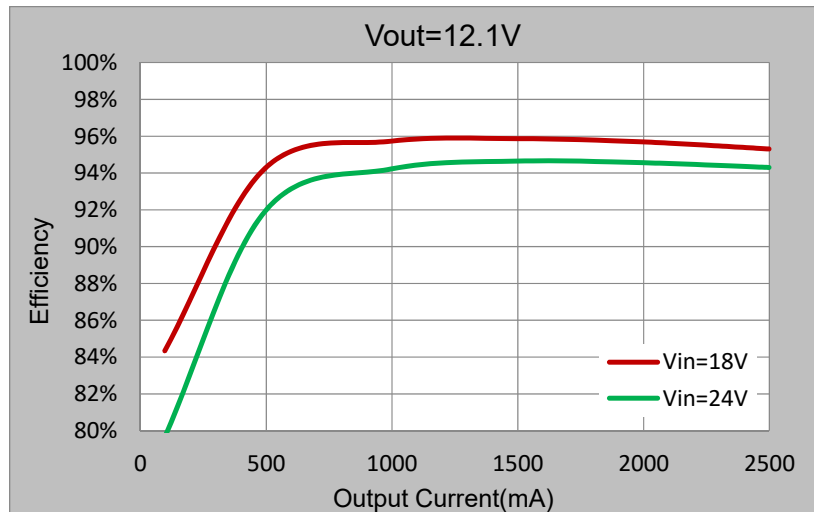
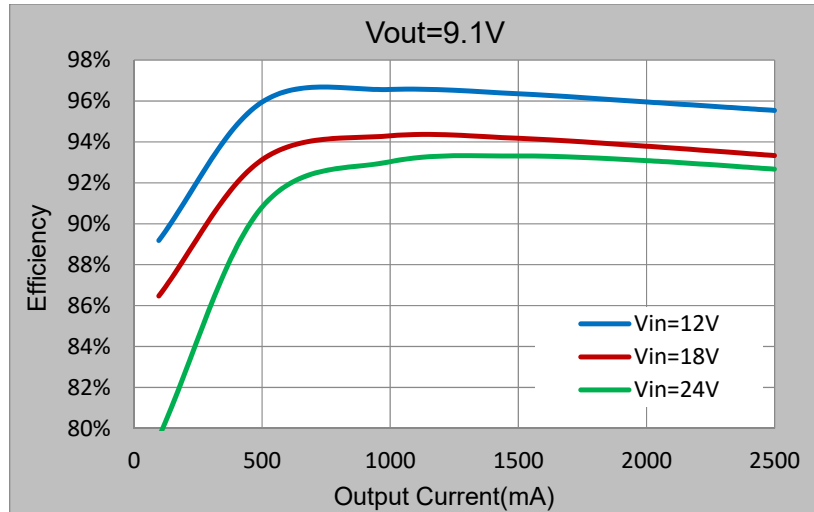

**Power Loss**

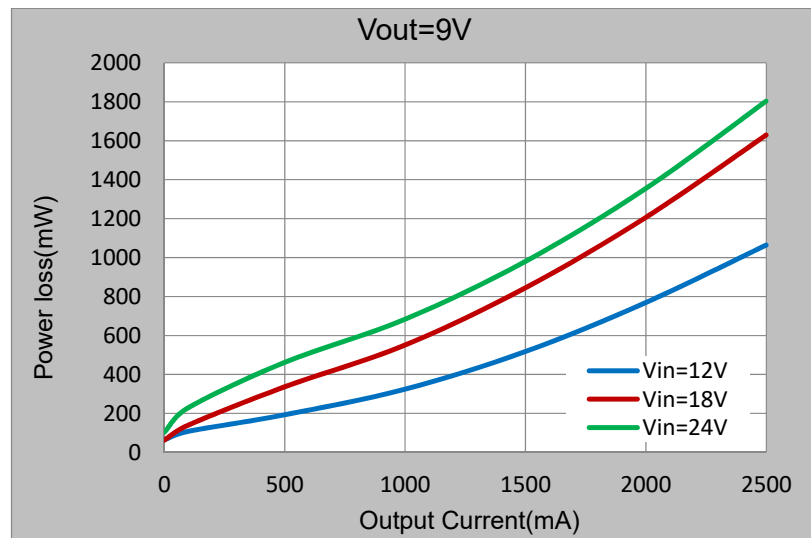
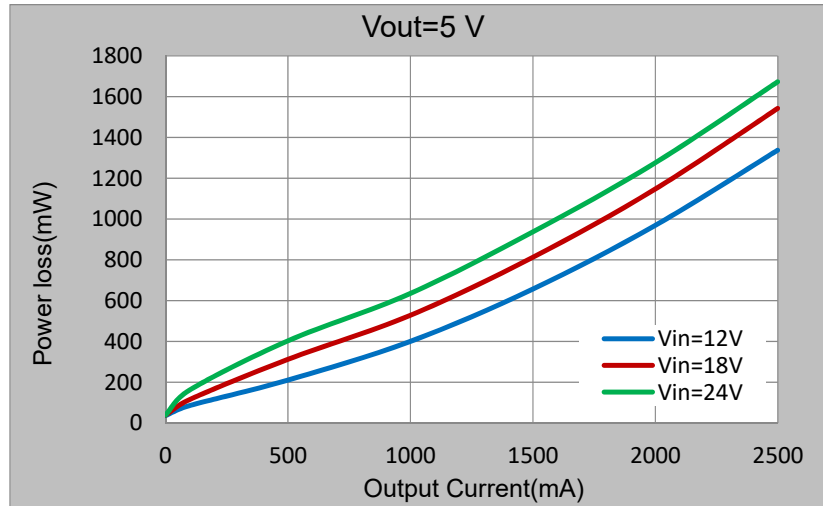



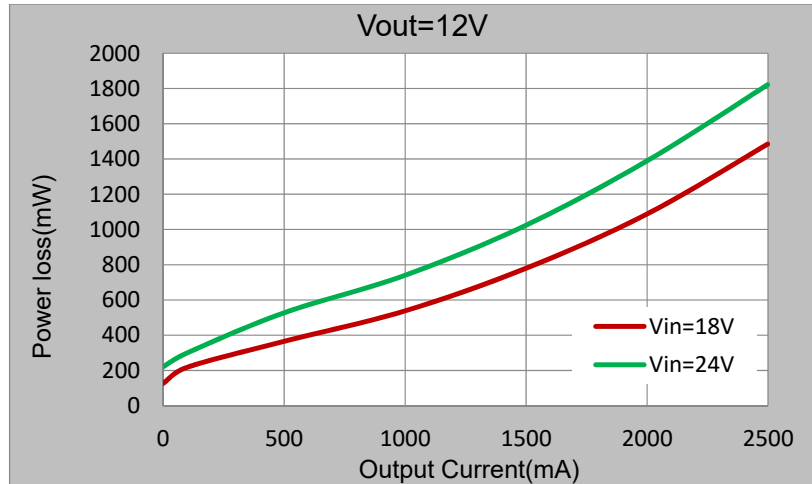

**Output Constant Current and Constant Voltage (Ta=25°C)**

Set DC load to CC mode, increase output current from 0A to the maximum load current and measure the voltage on the C3 capacitor. Then set DC electronic load to CV mode, decrease output voltage from maximum load voltage to 0V and measure the output current and the output voltage on the C3 capacitor.

Vo=5 V

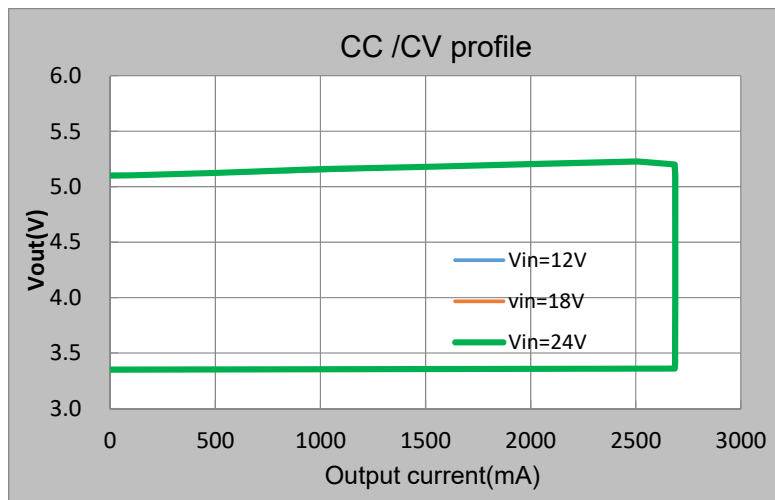

Vo=9V

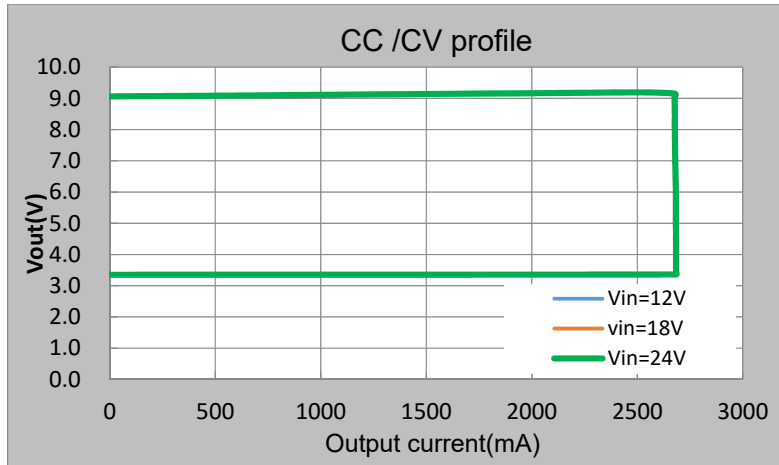

Vo=12V

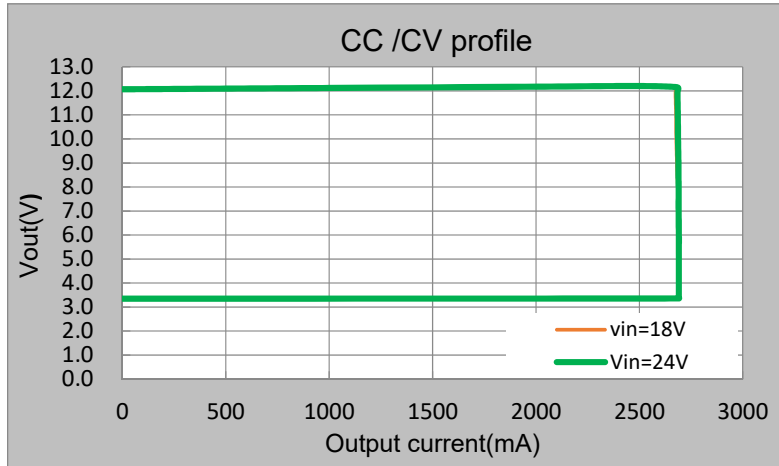

**Standby Input Current**

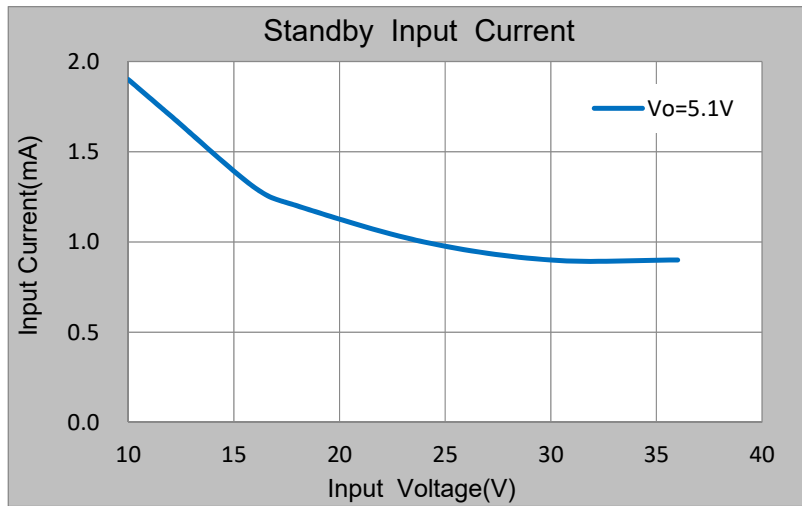

**Current Limit vs. input voltage**

Set DC electronic load to CV mode to measure the output current.

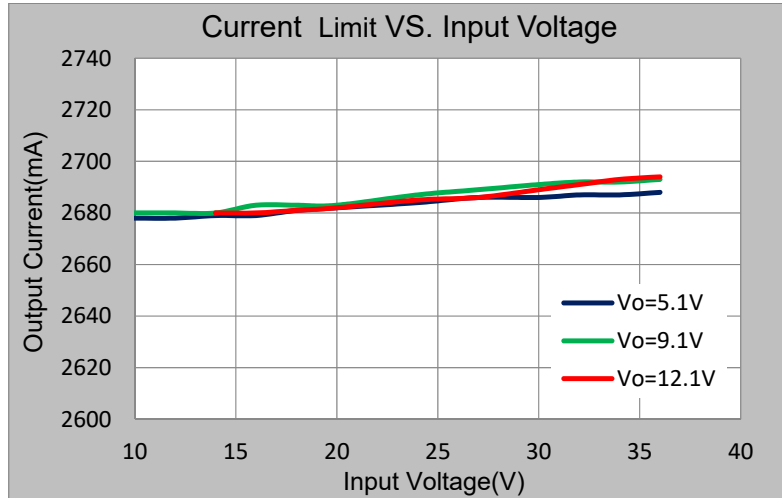

**Ripple**

CH1:Vsw, CH2:Vout

Vin=10V Vout=5.1V Iout=1A

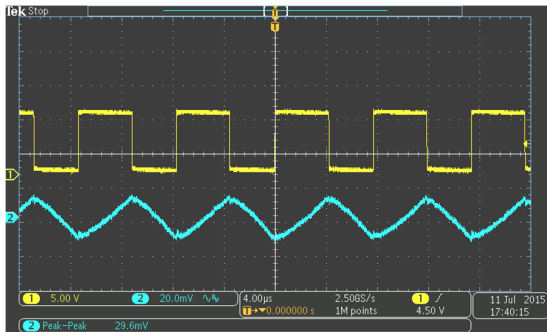

Vin=10V Vout=5.1V Iout=2.4A

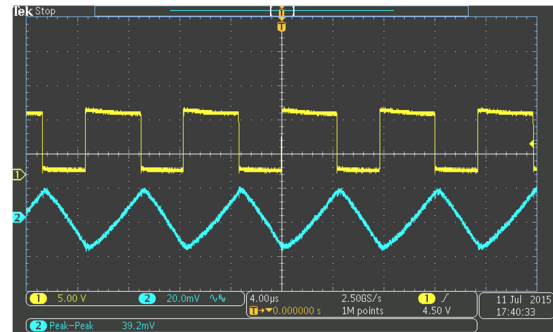

Vin=24V Vout=5.1V Iout=1A

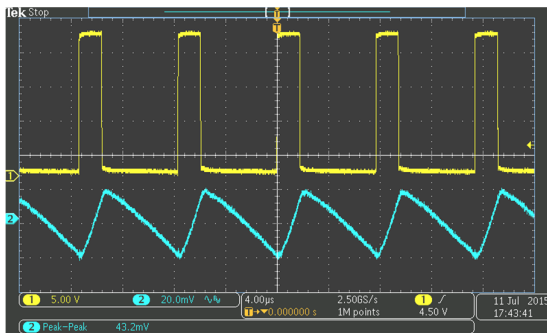

Vin=24V Vout=5.1V Iout=2.4A

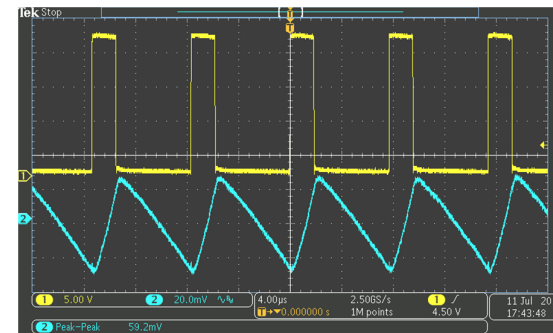

Vin=10V Vout=9.1V Iout=1A

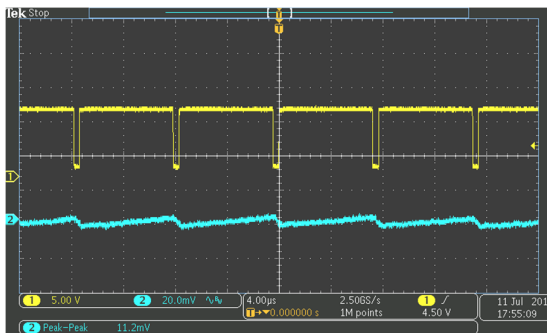

Vin=24V Vout=9.1V Iout=2.4A

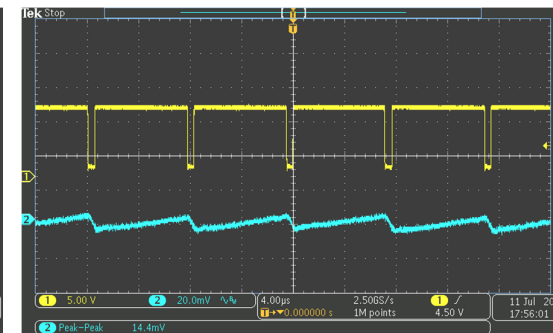

Vin=24V Vout=9.1V Iout=1A

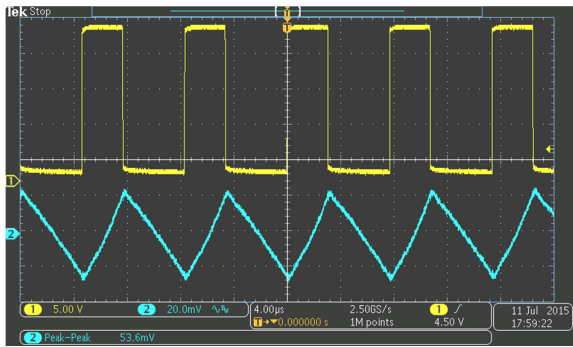

Vin=24V Vout=9.1V Iout=2.4A

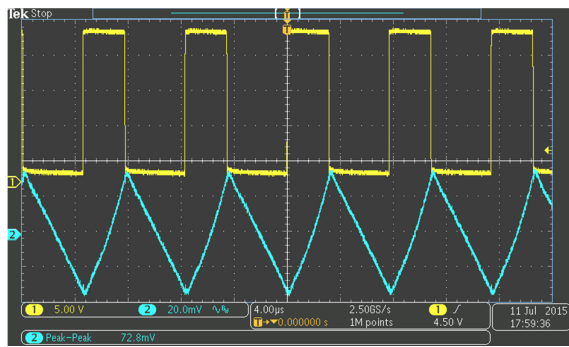

Vin=12V Vout=12.1V Iout=1A

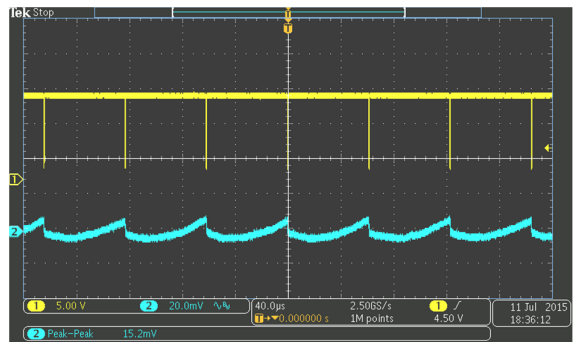

Vin=12V Vout=12.1V Iout=2.4A

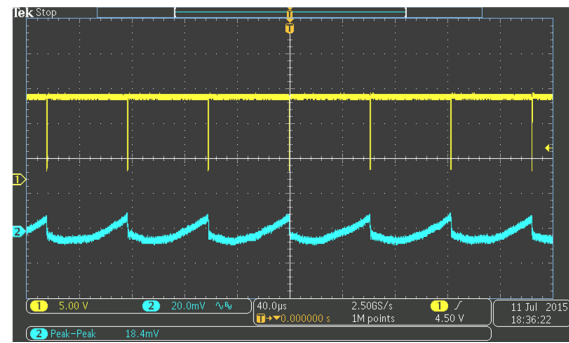

Vin=24V Vout=12.1V Iout=1A

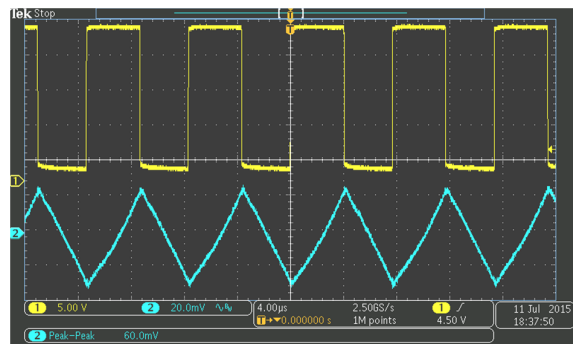

Vin=24V Vout=12.1V Iout=2.4A

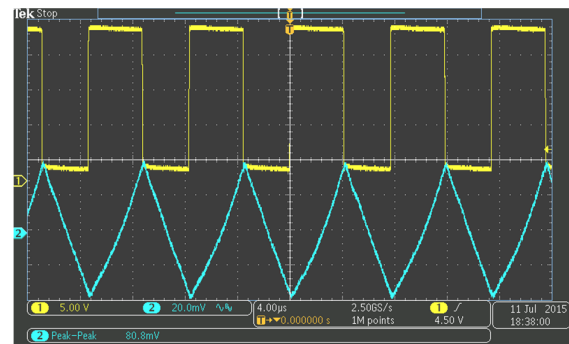

Ripple is measured by using 20MHz bandwidth limited oscilloscope.

Test Conditions		Output Ripple(mV)	
Vout(V)	Vin(V)	Io=1A	Io=2.4A
5.1	10	30	39
	24	43	59
9.1	10	11	14
	24	54	73
12.1	12	15	18
	24	60	80

### Load Dynamic Response

CH2:Vout ripple, CH4:Iout

Vout=5V

Vin=24V, load step 0A-0.5A-0A

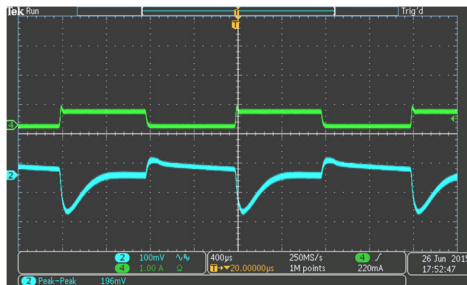

Vin=24V, load step 0.5A-1A-0.5A

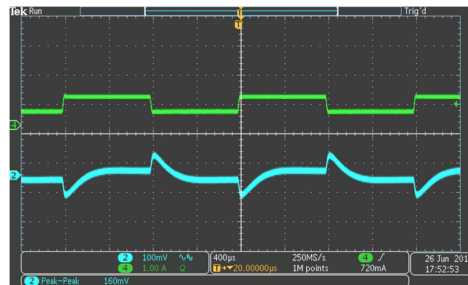

Vin=24V, load step 1A-1.5A-1A

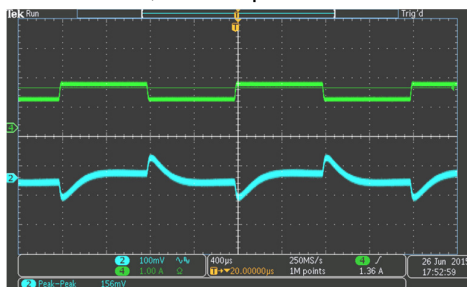

Vin=24V, load step 1.5A-2.4A-1.5A

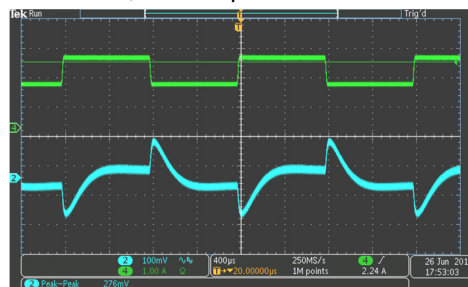

Vout=9V

Vin=24V, load step 0A-0.5A-0A

Vin=24V, load step 0.5A-1A-0.5A

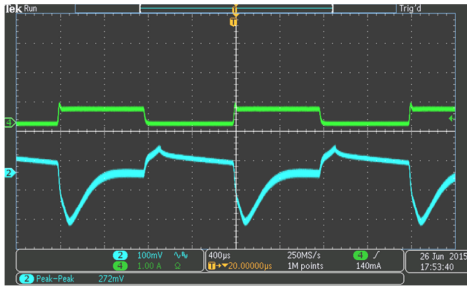

Vin=24V, load step 1A-1.5A-1A

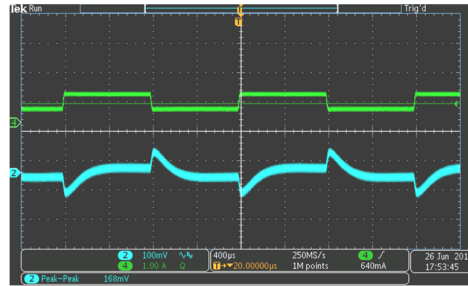

Vin=24V, load step 1.5A-2.4A-1.5A

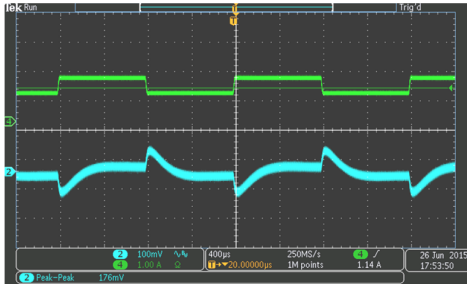

Vout=12V

Vin=24V, load step 0A-0.5A -0A

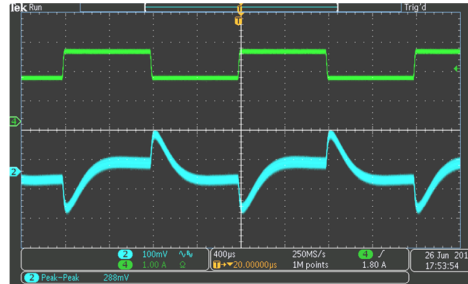

Vin=24V, load step 0.5A-1A-0.5A

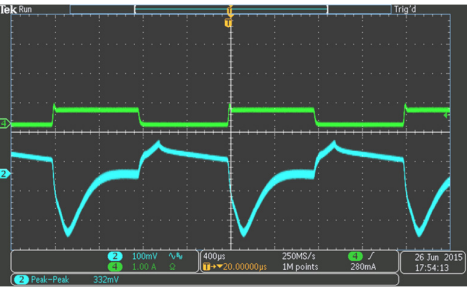

Vin=24V, load step 1A-1.5A-1A

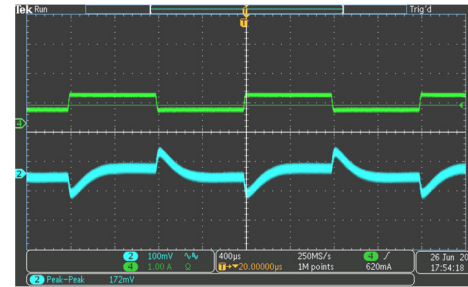

Vin=24V, load step 0.5A-1A-0.5A

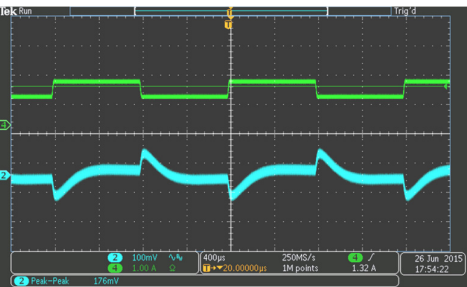

Vin=24V, load step 1A-1.5A-1A

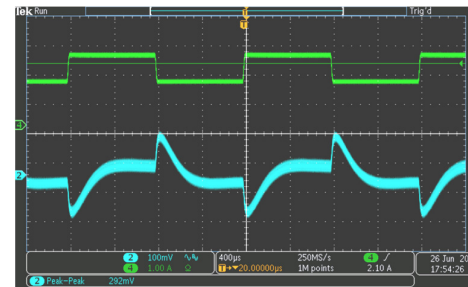

Vin=24V, load step 1.5A-2.4A-1.5A

**Line Dynamic Response(Vin change from 12V to 40V, 0.1V/us)**

CH1:Vin, CH2:Vout ripple , output 5V/2.4A

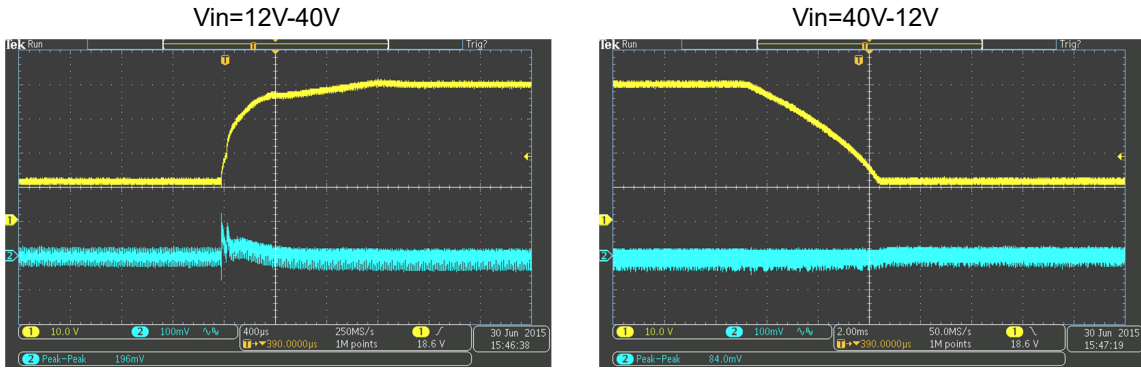

**Output Voltage Transient**

CH2:Vout,CH3:Vsw,CH4:IL

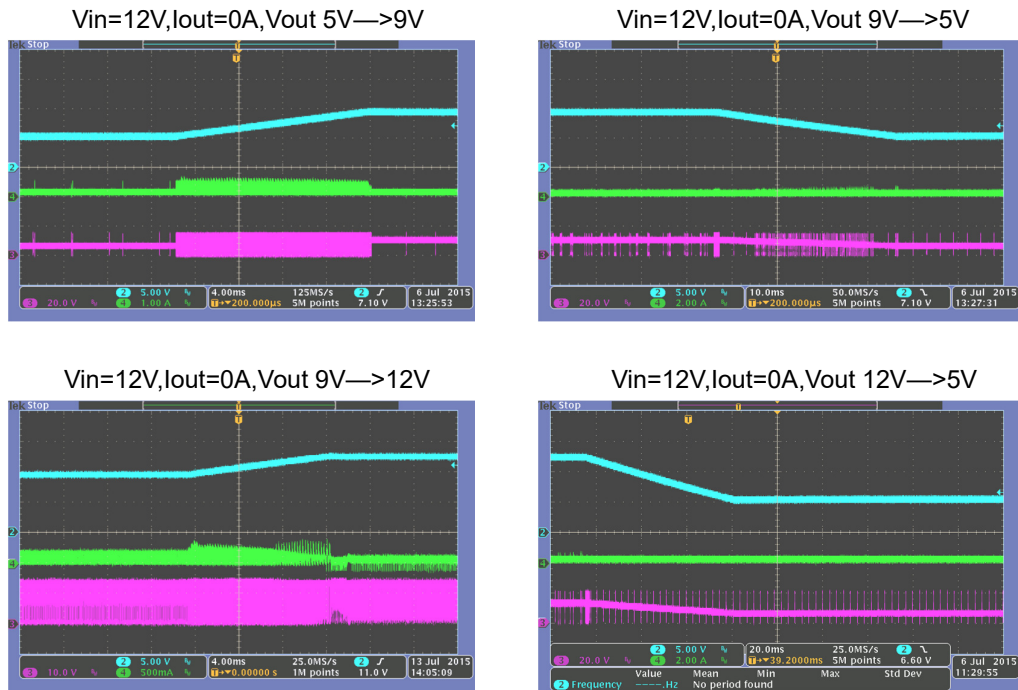



Vin=12V,Iout=2.4A,Vout 5V→9V

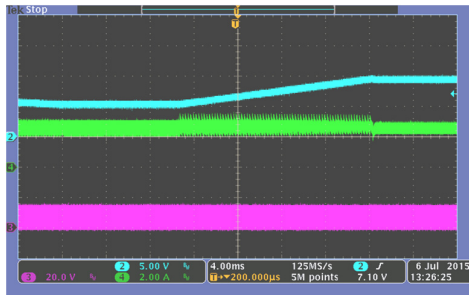

Vin=12V,Iout=2.4A,Vout 9V→5V

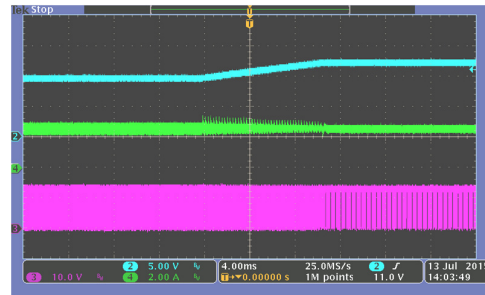

Vin=12V,Iout=2.4A,Vout 9V→12V

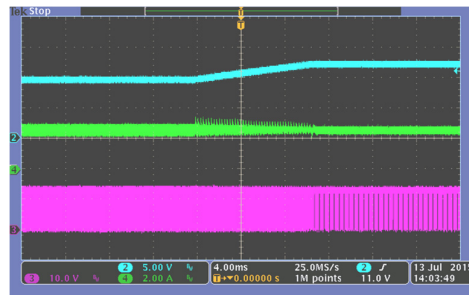

Vin=12V,Iout=2.4A,Vout 12V→5V

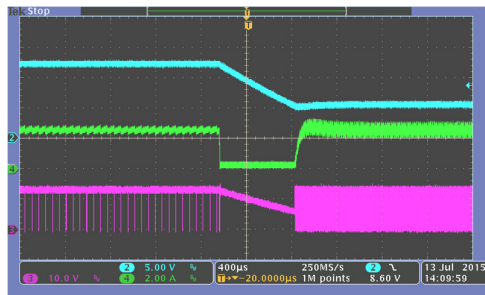

**Key Components Temperature Test**  
 (Ta=25deg C, after 2 hour steady state operation)

Vout=5V

Vin/Iout	Ambient (°C)	PCB (°C)	IC (°C)	Schottky (°C)	Inductor (°C)
12V/2.4A	32	91	94	96	96
16V/2.4A	34	96	98	103	102
24V/2.4A	32	100	103	108	107

Vout=9V

Vin/Iout	Ambient (°C)	PCB (°C)	IC (°C)	Schottky (°C)	Inductor (°C)
12V/2A	32	75	74	73	71
16V/2A	35	83	84	86	85
24V/2A	34	91	92	95	92

Vout=12V

Vin/Iout	Ambient (°C)	PCB (°C)	IC (°C)	Schottky (°C)	Inductor (°C)
12V/2A	36	71	74	65	71
16V/2A	37	80	84	79	82
24V/2A	38	91	97	91	94



**EMI TEST**

**Output=5V**

Vin=12V Output 5V2.4A Horizontal

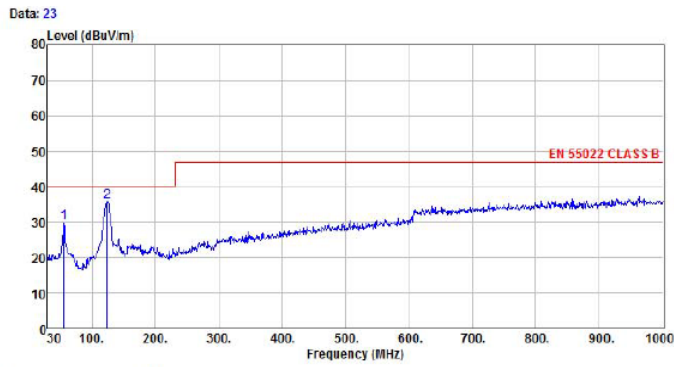

Data: 23  
 Site : chamber  
 Condition : EN 55022 CLASS B 3m VULB9160 HORIZONTAL  
 EUT :  
 Model Name : 5  
 Temp/Humi : 25°C / 53 %  
 Power Rating: AC 230V/50Hz  
 Mode :  
 Memo :

	Freq	ReadAntenna	Cable	Preamp	Limit	Over				
	MHz	Level	Factor	Loss	Level	Line	Limit	Remark	Factor	
	MHz	dBuV	dB/m	dB	dB	dBuV/m	dBuV/m	dB	dB/m	
1	55.22	16.32	12.40	1.00	0.00	29.72	40.00	-10.28	Peak	13.40
2	pp 124.09	21.86	12.27	1.51	0.00	35.64	40.00	-4.36	Peak	13.78

Vin=12V Output 5V2.4A Vertical

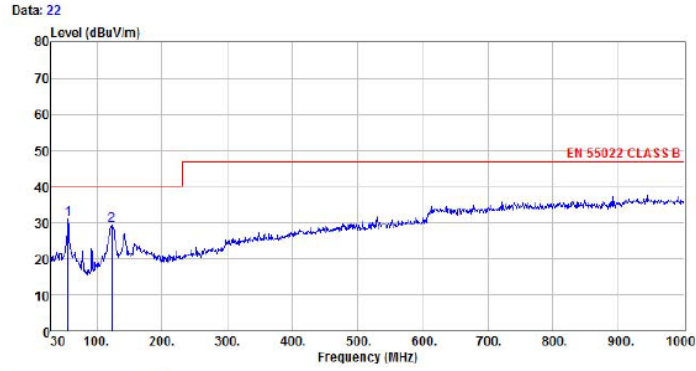

Site : chamber  
 Condition : EN 55022 CLASS B 3m VULB9160 VERTICAL  
 EUT :  
 Model Name : 5  
 Temp/Humi : 25°C / 53 %  
 Power Rating: AC 230V/50Hz  
 Mode :  
 Memo :

	Freq	ReadAntenna Level	Antenna Factor	Cable Loss	Preamp Factor	Level	Limit Line	Over Limit	Remark	Factor
	MHz	dBuV	dB/m	dB	dB	dBuV/m	dBuV/m	dB		dB/m
1	pp	55.22	17.71	12.40	1.00	0.00	31.11	40.00	-8.89 Peak	13.40
2		123.12	15.33	12.27	1.50	0.00	29.10	40.00	-10.90 Peak	13.77

**Output=9V**

Vin=12V Output 9V2.4A Horizontal

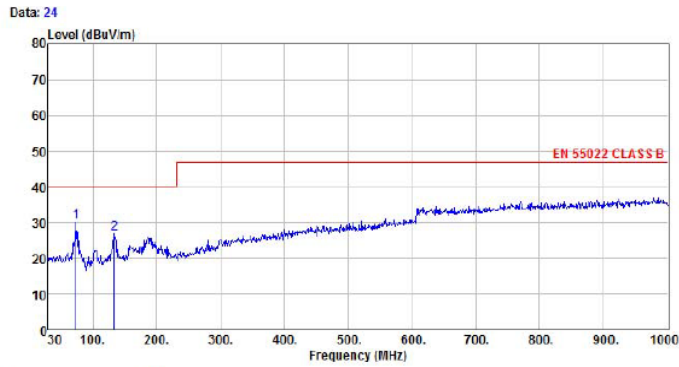

Site : chamber  
 Condition : EN 55022 CLASS B 3m VULB9160 HORIZONTAL  
 EUT :  
 Model Name : 7  
 Temp/Humi : 25°C / 53 %  
 Power Rating: AC 230V/50Hz  
 Mode :  
 Memo :

	Freq	ReadAntenna	Cable	Preamp	Limit	Over				
	MHz	Level	Loss	Factor	Level	Line	Limit	Remark	Factor	
	MHz	dBuV	dB/m	dB	dB	dBuV/m	dBuV/m	dB	dB/m	
1	pp	73.65	19.13	9.87	1.12	0.00	30.12	40.00	-9.88 Peak	10.99
2		133.79	12.29	12.92	1.61	0.00	26.82	40.00	-13.18 Peak	14.53

Vin=12V Output 9V2.4A Vertical

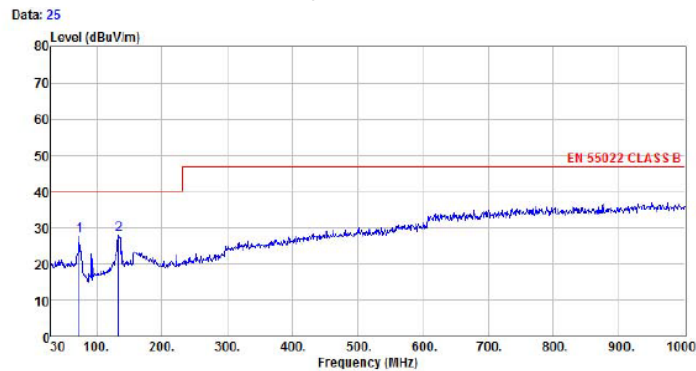

Site : chamber  
 Condition : EN 55022 CLASS B 3m VULB9160 VERTICAL  
 EUT :  
 Model Name : 7  
 Temp/Humi : 25°C / 53 %  
 Power Rating: AC 230V/50Hz  
 Mode :  
 Memo :

	Freq	ReadAntenna	Cable	Preamp	Limit	Over				
	MHz	Level	Loss	Factor	Level	Line	Limit	Remark	Factor	
	MHz	dBuV	dB/m	dB	dB	dBuV/m	dBuV/m	dB	dB/m	
1		73.65	16.69	9.87	1.12	0.00	27.68	40.00	-12.32 Peak	10.99
2	pp	133.79	13.50	12.92	1.61	0.00	28.03	40.00	-11.97 Peak	14.53

**Schematic**

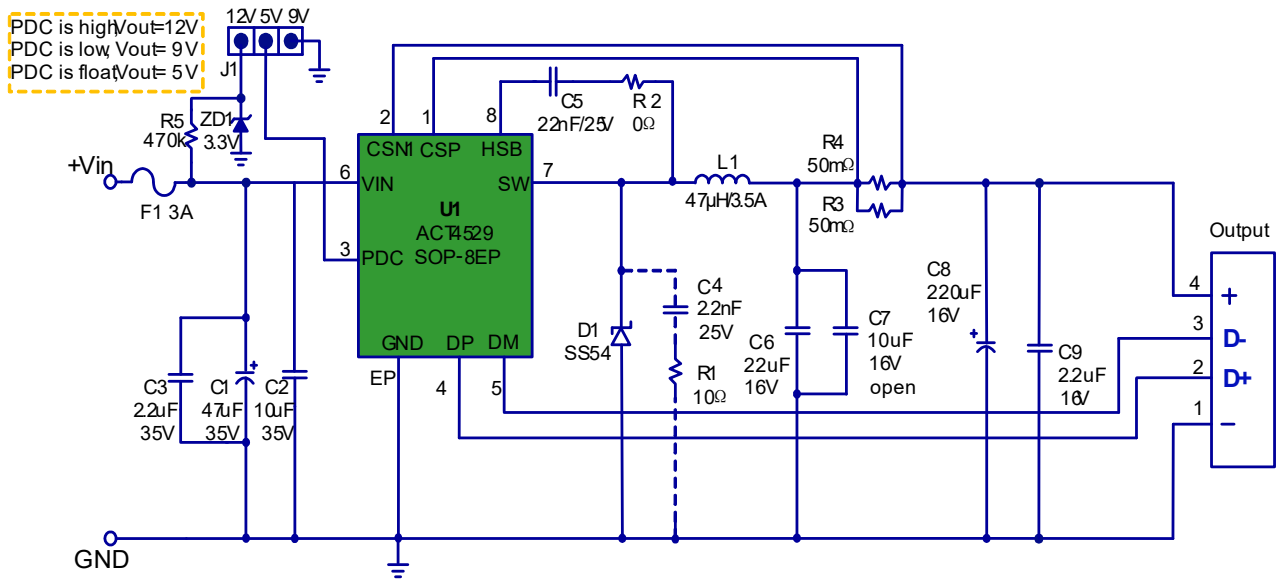

**Bill of Materials**

Item	Designator	QTY	Description	Package	MFR
1	L1	1	Choke Coil, Dip, T9*5*4mm, phi=0.55mm, L=47uH		
2	D1	1	Schottky Diode, SK54BL, 40V/5A	SMB	Panjit
3	C1	1	Electrolytic capacitor, 47uF/35V	, 6.3x8mm	Koshin
4	C2	1	Ceramic capacitor, 10uF/35V, X7R	1206	Murata/TKD
5	C3	1	Ceramic capacitor, 2.2uF/35V, X7R	0805	Murata/TKD
6	C4	1	Ceramic capacitor, 2.2nF/25V, X7R	0603	Murata/TKD
7	C5	1	Ceramic capacitor, 22nF/25V, X7R	0603	Murata/TKD
8	C6	1	Ceramic capacitor, 22uF/16V, X7R	0805	Murata/TKD
9	C7	1	Ceramic capacitor, 10uF/16V, X7R	0805	Murata/TKD
10	C8	1	Electrolytic capacitor, 220uF/16V	7x11.5mm	HUAKAI
11	C9	1	Ceramic capacitor, 2.2uF/16V, X7R	0603	Murata/TKD
12	F1	1	Fuse, 3A ( Replaced by 0Ω 0805 chip resistor )	1206	Murata/TKD
13	R1	1	Chip Resistor, 5.1Ω, 1/8W, 5%,	0805	Murata/TKD
14	R2	1	Chip Resistor, 0Ω, 1/10W, 5%,	0603	Murata/TKD
15	R3/R4	2	Chip Resistor, 50mΩ, 1/4W, 1%	1206	Murata/TKD
16	R5	1	Chip Resistor, 470K, 1/10W, 5%	0603	Murata/TKD
17	ZD1	1	Zener diode, MMSZ5226BS, 3.3V	SOD-323	Panjit
18	U1	1	IC, ACT4529YH-T1011	SOP-8-EP	ACT
19	USB	1	USB Rev: A		
20	PCB	1	ACT4529 20160621		

## X-ON Electronics

Largest Supplier of Electrical and Electronic Components

*Click to view similar products for [Power Management IC Development Tools](#) category:*

*Click to view products by [Active-Semi manufacturer](#):*

Other Similar products are found below :

[EVAL-ADM1168LQEBZ](#) [EVB-EP5348UI](#) [MIC23451-AAAYFL EV](#) [MIC5281YMME EV](#) [DA9063-EVAL](#) [ADP122-3.3-EVALZ](#) [ADP130-0.8-EVALZ](#) [ADP130-1.2-EVALZ](#) [ADP130-1.5-EVALZ](#) [ADP130-1.8-EVALZ](#) [ADP1714-3.3-EVALZ](#) [ADP1716-2.5-EVALZ](#) [ADP1740-1.5-EVALZ](#) [ADP1752-1.5-EVALZ](#) [ADP1828LC-EVALZ](#) [ADP1870-0.3-EVALZ](#) [ADP1871-0.6-EVALZ](#) [ADP1873-0.6-EVALZ](#) [ADP1874-0.3-EVALZ](#) [ADP1882-1.0-EVALZ](#) [ADP199CB-EVALZ](#) [ADP2102-1.25-EVALZ](#) [ADP2102-1.875EVALZ](#) [ADP2102-1.8-EVALZ](#) [ADP2102-2-EVALZ](#) [ADP2102-3-EVALZ](#) [ADP2102-4-EVALZ](#) [ADP2106-1.8-EVALZ](#) [ADP2147CB-110EVALZ](#) [AS3606-DB](#) [BQ24010EVM](#) [BQ24075TEVM](#) [BQ24155EVM](#) [BQ24157EVM-697](#) [BQ24160EVM-742](#) [BQ24296MEVM-655](#) [BQ25010EVM](#) [BQ3055EVM](#) [NCV891330PD50GEVB](#) [ISLUSBI2CKIT1Z](#) [LM2744EVAL](#) [LM2854EVAL](#) [LM3658SD-AEV/NOPB](#) [LM3658SDEV/NOPB](#) [LM3691TL-1.8EV/NOPB](#) [LM4510SDEV/NOPB](#) [LM5033SD-EVAL](#) [LP38512TS-1.8EV](#) [EVAL-ADM1186-1MBZ](#) [EVAL-ADM1186-2MBZ](#)