

# ON TAT INDUSTRIAL COMPANY

---

## SPECIFICATION

Product Model: CH430WQ01-T (Rev.A)

Designed by	R&D Checked by	Quality Department by	Approved by

### Approval by Customer

<p>OK</p> <p>NG, Problem survey:</p> <p style="text-align: right;">Approved By _____</p>
--



**Table Of Contents**

<b>List</b>	<b>Description</b>	<b>Page No.</b>
	Cover	1
	Revision Record	2
	Table Of Contents	3
1	Numbering System	4
2	General Information	4
3	External Dimensions	5
4	Interface Description	6
5	Absolute Maximum Ratings	6
6	Electrical Characteristics	6
7	Timing Characteristics	7
8	Backlight Characteristics	8
9	Optical Characteristics	9
10	Reliability Test Conditions And Methods	11
11	Inspection Standard	12
12	Handling Precautions	15
13	Precaution For Use	16
14	Packing Method	16

## 1. Numbering System

TBD

## 2. General Information

ITEM	STANDARD VALUES	UNITS
LCD type	4.3" TFT	--
Dot arrangement	480(RGB)×272	dots
Color filter array	RGB vertical stripe	--
Display mode	TN / Transmission / Normally White	--
Viewing Direction	12 o'clock	--
Driver IC	-	--
Module size	105.5(W)×67.2(H)×4.1(T)	mm
Active area	95.04(W)×53.856(H)	mm
Dot pitch	0.198 (W)×0.198 (H)	mm
Interface	24-bit Parallel RGB Interface	--
Operating temperature	-20 ~ +70	°C
Storage temperature	-30 ~ +80	°C
Back Light	7 White LED	--
Weight	TBD	g

### 3. External Dimensions

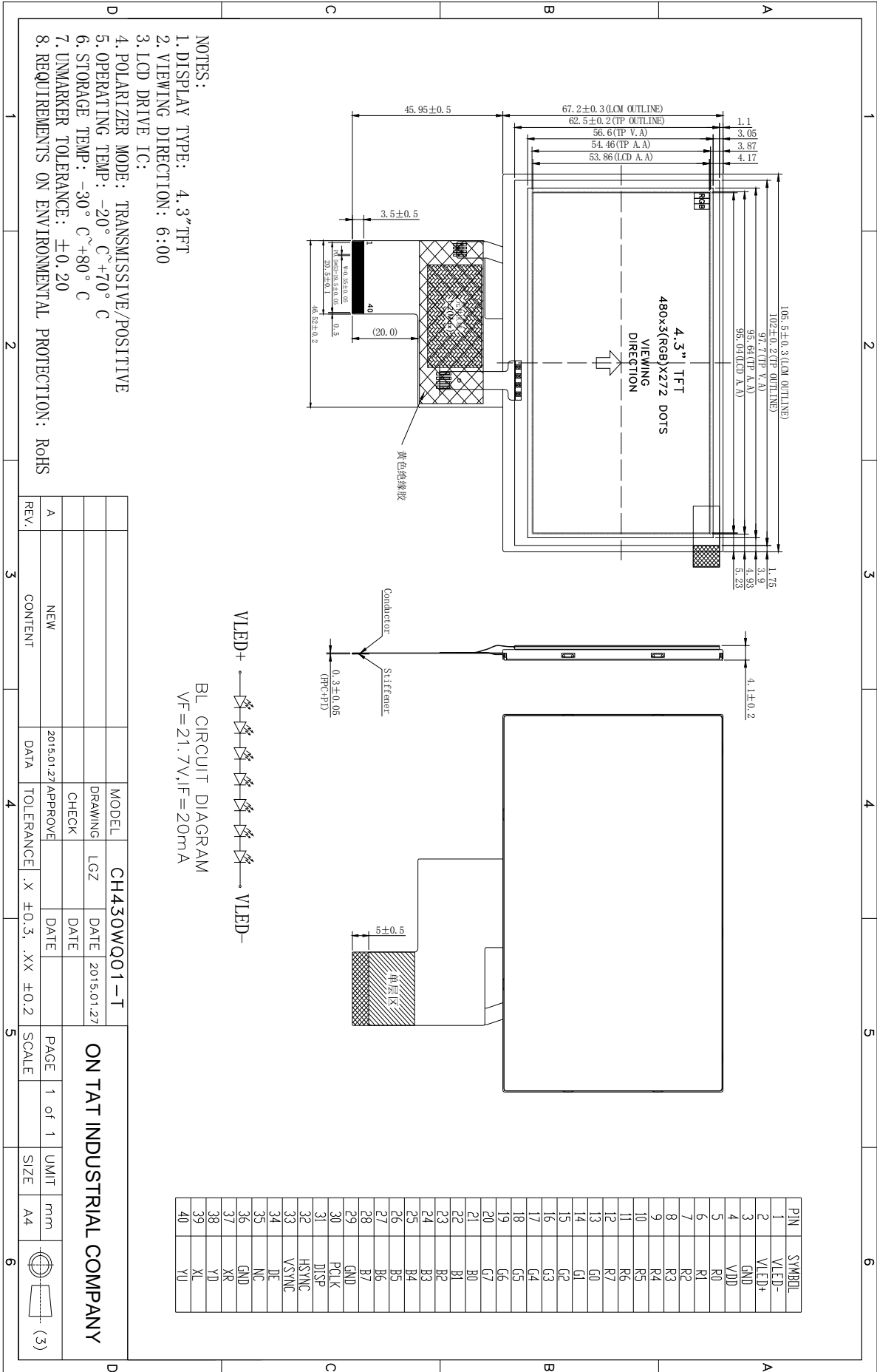

## 4. Interface Description

Pin	Symbol	Description.
1	VLED-	LED backlight (Cathode).
2	VLED+	LED backlight (Anode).
3	GND	Ground.
4	VDD	Power supply.
5~12	R0~R7	Red Data.
13~20	G0~G7	Green Data.
21~28	B0~B7	Blue Data.
29	GND	Ground.
30	PCLK	Dot clock signal input. Latching input data at its rising edge.
31	DISP	Display on/off.
32	HSYNC	Horizontal sync input. Negative polarity.
33	VSYNC	Vertical sync input. Negative polarity.
34	DE	Data enable input. Active high to enable the input data bus.
35	NC	NC.
36	GND	Ground.
37	XR	TP Right.
38	YD	TP Bottom.
39	XL	TP Left.
40	YU	TP Up.

## 5. Absolute Maximum Ratings

Item	Symbol	Min.	Max.	Unit
Analog Supply Voltage	VDD	-0.3	5	V
Input Voltage	V <sub>in</sub>	-0.3	VDD+0.3	V
Operating Temperature	T <sub>OP</sub>	-20	70	°C
Storage Temperature	T <sub>ST</sub>	-30	80	°C
Storage Humidity	HD	20	90	%RH

## 6. DC Characteristics

Item	Symbol	Min.	Typ.	Max.	Unit	Remark
Analog Supply Voltage	VDD	3.0	3.3	3.6	V	-
Input High Voltage	V <sub>IH</sub>	0.7VDD	-	VDD	V	Digital input pins
Input Low Voltage	V <sub>IL</sub>	GND	-	0.3VDD	V	Digital input pins
Output High Voltage	V <sub>OH</sub>	VDD-0.4	-	VDD	V	Digital output pins
Output Low Voltage	V <sub>OL</sub>	GND	-	VDD+0.4	V	Digital output pins
I/O Leak Current	I <sub>LI</sub>	-1	-	1	uA	-

## 7. Timing Characteristics

### 7.1 Power ON/OFF Sequence

#### Power ON Sequence

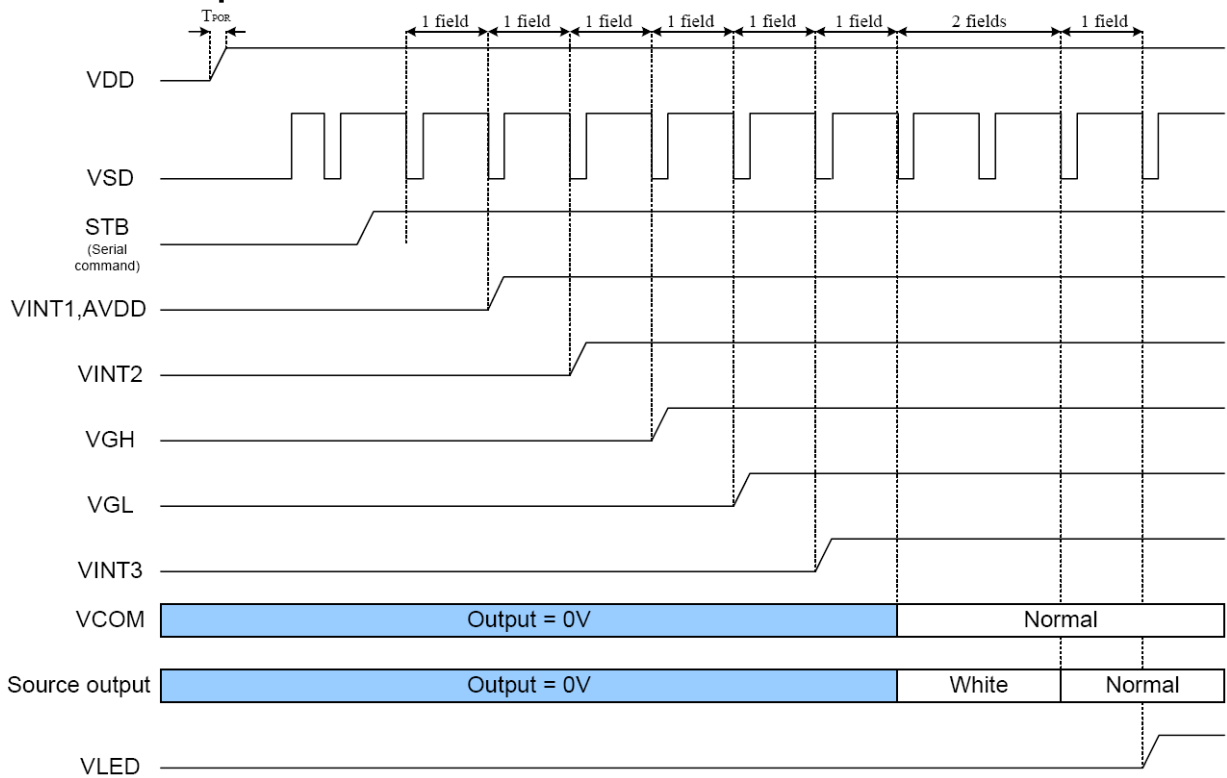

#### Power OFF Sequence

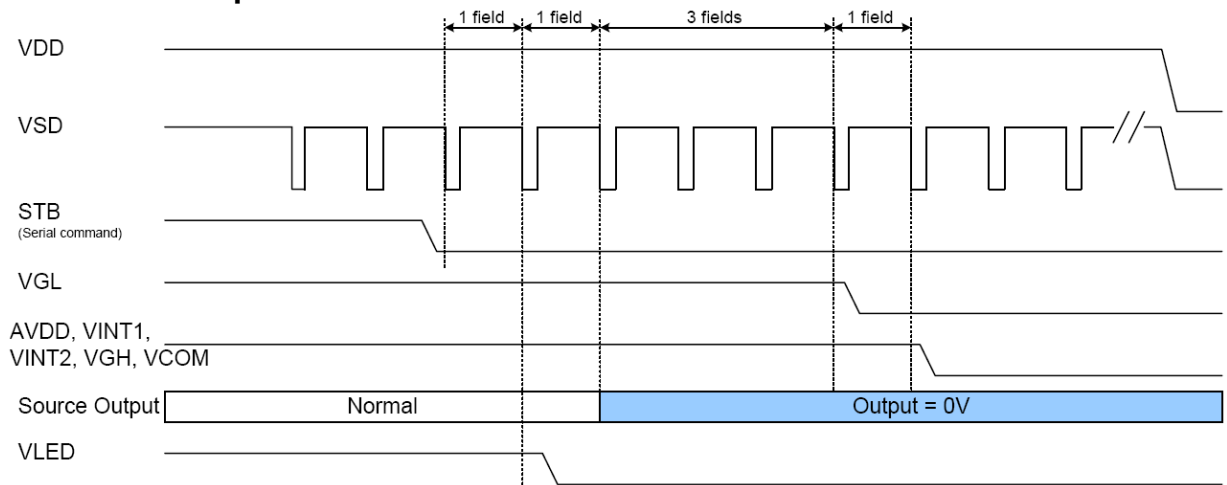

## 7.2 Data Input Format

### 7.2.1 Vertical input timing

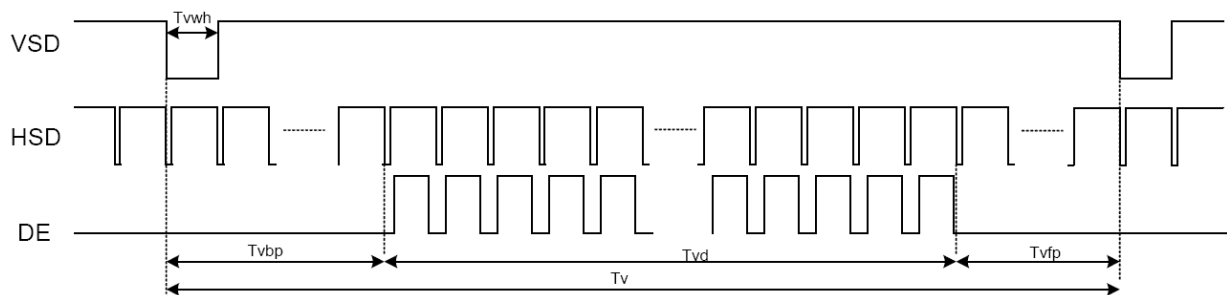

### 7.2.2 Parallel RGB Mode Data format

(HV Mode)

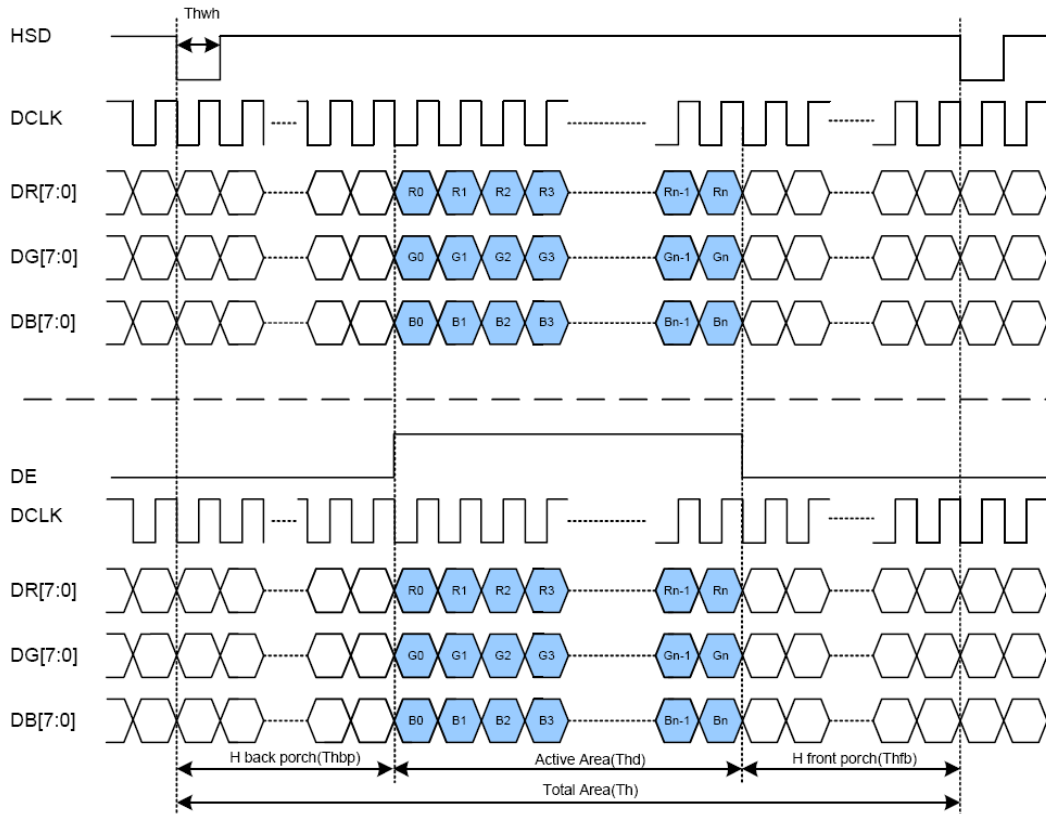

(DE Mode)

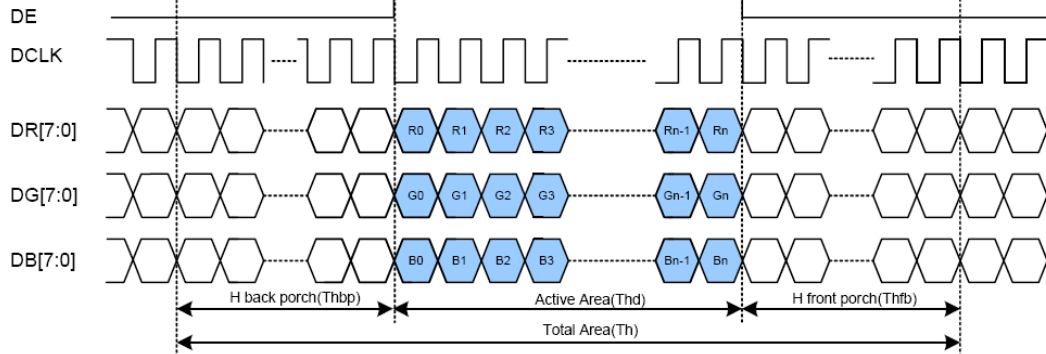

### 7.2.3 Parallel RGB input timing table

Parameter	Symbol	Value			Unit
		Min.	Typ.	Max.	
DCLK frequency	fclk	5	9	12	MHz
VSD period time	$T_v$	277	288	400	H
VSD display area	$T_{vd}$	272			H
VSD back porch	$T_{vb}$	3	8	31	H
VSD front porch	$T_{vfp}$	2	8	93	H
HSD period time	$T_h$	520	525	800	DCLK
HSD display area	$T_{hd}$	480			DCLK
HSD back porch	$T_{hbp}$	36	40	255	DCLK
HSD front porch	$T_{hfp}$	4	5	65	DCLK

## 8. Backlight Characteristics

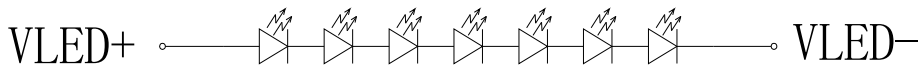

Item	Symbol	MIN	TYP	MAX	UNIT	Test Condition
Supply Voltage	$V_f$	20.3	22.4	24.5	V	$I_f=20mA$
Supply Current	$I_f$	-	20	30	mA	-
Luminous Intensity for LCM	-	150	200	-	$Cd/m^2$	$I_f=20mA$
Uniformity for LCM	-	80	-	-	%	$I_f=20mA$
Life Time	-	20000	-	-	Hr	$I_f=20mA$
Backlight Color	White					



### 9. Optical Characteristics

Item	Symbol	Condition	Min.	Typ.	Max.	Unit	Note
Threshold voltage	V <sub>sat</sub>		—	2.4	—		(1)
	V <sub>th</sub>		—	1.4	—		(1)
Transmittance (Without PZ)	T		—	19.1	—	%	
Contrast	CR		480	600	—		(2)(3)
Response time	Rising	T <sub>R</sub>	—	3	6	msec	(2)(4)
	Falling	T <sub>F</sub>	—	7	14		
Color gamut	S		—	50	—	%	C light
Color chromaticity (CIE1931)	White	W <sub>x</sub>	θ=0 Normal viewing angle	0.292	0.307	0.322	(2)(5) CF Glass C light
		W <sub>y</sub>		0.333	0.348	0.363	
	Red	R <sub>x</sub>		0.616	0.631	0.646	
		R <sub>y</sub>		0.327	0.342	0.357	
	Green	G <sub>x</sub>		0.306	0.321	0.336	
		G <sub>y</sub>		0.538	0.553	0.568	
	Blue	B <sub>x</sub>		0.134	0.149	0.164	
		B <sub>y</sub>		0.168	0.183	0.198	
Viewing angle (With EWV PZ)	Hor.	θ <sub>L</sub>	CR>10	65	75	—	
		θ <sub>R</sub>		65	75	—	
	Ver.	θ <sub>U</sub>		50	60	—	
		θ <sub>D</sub>		60	70	—	
Optima View Direction	6 O' clock						(6)

**Measuring Condition:**

Dark room, 25±2°C, 15min. warm-up time.

**Measuring Equipment**

FPM520 of Westar Display technologies, INC., which utilized SR-3 for Chromaticity and BM-5A for other optical characteristics. Measuring spot size: 20 ~ 21 mm.

Note (1) Definition of Viewing Angle :

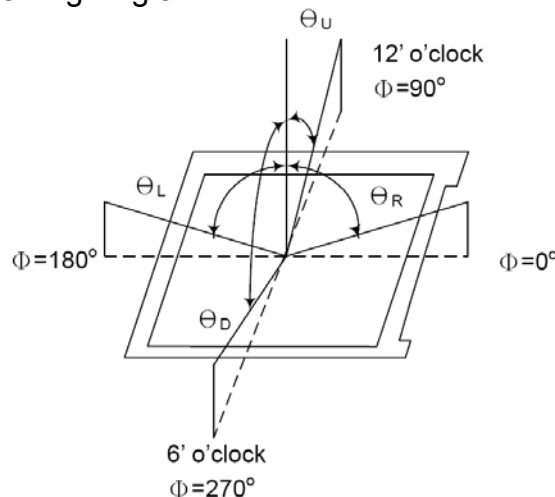

Note (2) Definition of Contrast Ratio(CR) :

Measured at the center point of panel

CR = Luminance with all pixels white / Luminance with all pixels black

Note (3) Definition of Response Time : Sum of TR and TF

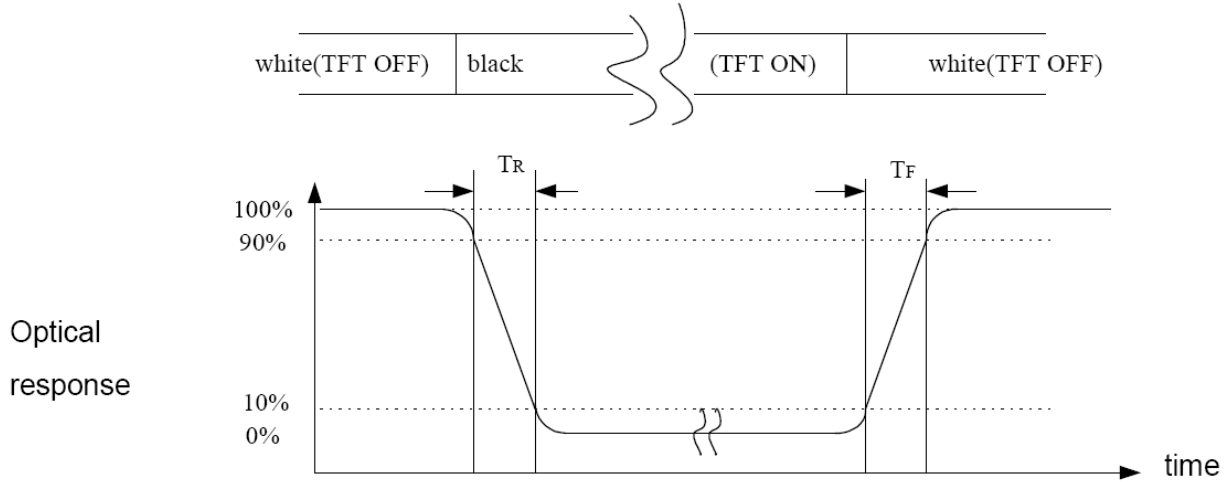

Note (4) Definition of optical measurement setup

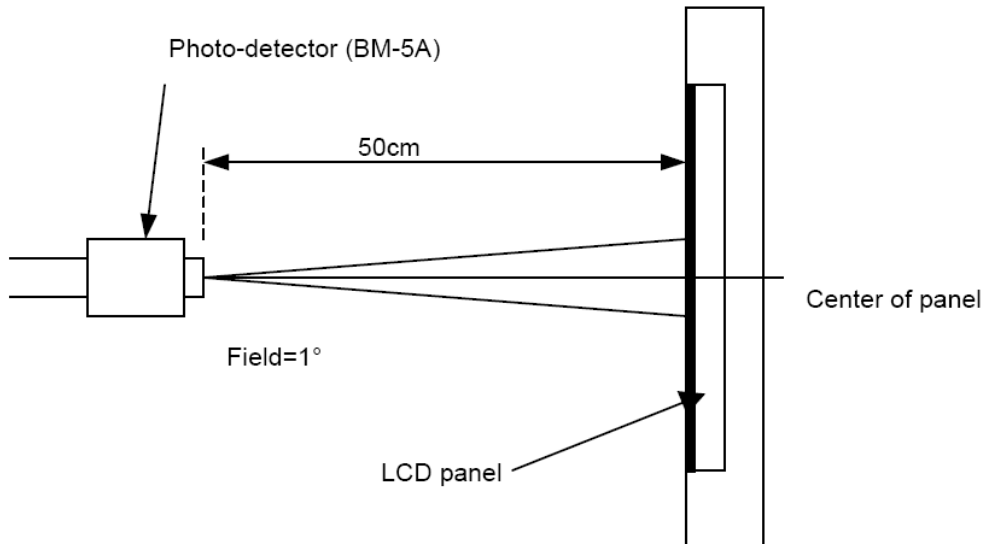

Note (5) Rubbing Direction (The different Rubbing Direction will cause the different optima view direction). TFT Face UP

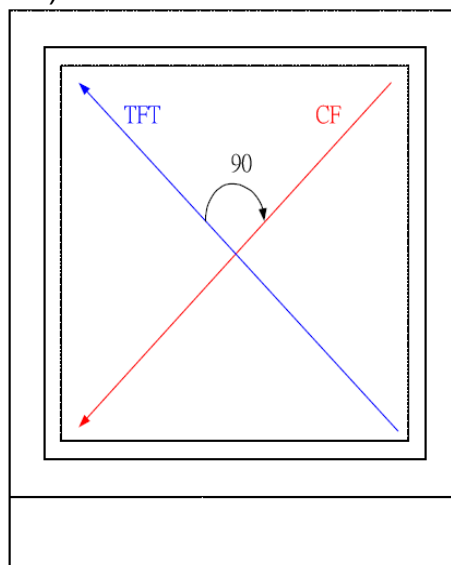

## 10. Reliability Test Conditions And Methods

NO.	TEST ITEMS	TEST CONDITION	INSPECTION AFTER TEST
①	High Temperature Storage	80°C±2°C×200Hours	Inspection after 2~4hours storage at room temperature,the samples should be free from defects: 1,Air bubble in the LCD. 2,Sealleak. 3,Non-display. 4,Missing segments. 5,Glass crack. 6,Current IDD is twice higher than initial value. 7,The surface shall be free from damage. 8,The electric charateristic requirements shall be satisfied.
②	Low Temperature Storage	-30°C±2°C×200Hours	
③	High Temperature Operating	70°C±2°C×120Hours	
④	Low Temperature Operating	-20°C±2°C×120Hours	
⑤	Temperature Cycle(Storage)	-20°C ↔ 25°C ↔ 70°C (30min) (5min) (30min) 1cycle Total 10cycle	
⑥	Damp Proof Test (Storage)	50°C±5°C×90%RH×120Hours	
⑦	Vibration Test	Frequency:10Hz~55Hz~10Hz Amplitude:1.5M X,Y,Z direction for total 3hours (Packing Condition)	
⑧	Drooping Test	Drop to the ground from 1M height one time every side of carton. (Packing Condition)	
⑨	ESD Test	Voltage:±8KV,R:330Ω,C:150PF,Air Mode,10times	

### REMARK:

- The Test samples should be applied to only one test item.
- Sample side for each test item is 5~10pcs.
- For Damp Proof Test,Pure water(Resistance > 10MΩ)should be used.
- In case of malfunction defect caused by ESD damage,if it would be recovered to normal state after resetting,it would be judge as a good part.
- EL evaluation should be excepted from reliability test with humidity and temperature:Some defects such as black spot/blemish can happen by natural chemical reaction with humidity and Fluorescence EL has.
- Failure Judgment Criterion:Basic Specification Electrical Characteristic,Mechanical Characteristic,Optical Characteristic.

## 11. Inspection Standard

This standard apply to C-STN/TFT module

### 1. Spot check plan:

According to spot check level II ,MIL-STD-105D Level II ,the rank of accept or reject is below:

3A 级、2A 级 : major non-conformance : AQL 0.25 minor non-conformance : AQL 0.4

A 级 : major non-conformance : AQL 0.65 minor non-conformance : AQL 1.

### 2. Inspection condition:

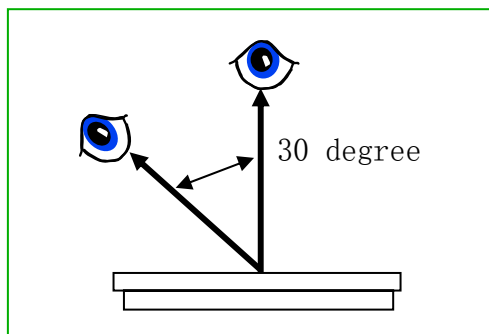

Under daylight lamp 20~40W, product distance inspector'eye 30cm,incline degree 30°.

### 3. LCD area define:

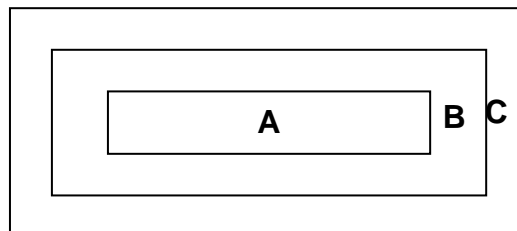

Area A: display area

Area B: VA area

Area C: out of VA area,not in sight after assembly

Remark :non-conformance at area C,but is OK that isn't influence raliability of product & assembly by customer.

**4. Inspection standard**

**4.1 Major non-conformance**

NO.	Item	Inspection standard	Rate
4.1.1	Function non-conformance	1) No display, display abnormaly 2) Miss line, short 3) B/L no function or function abnormaly 4) TP no function	major
4.1.2	miss	No matter miss what component	
4.1.3	Out of size	Module dimension out of spec	

**4.2 Appearance non-conformance**

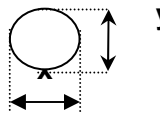
NO.	Item	Inspection standard	Rate																														
4.2.1	Black or white spot (power on)	<p>dot non-conformance define <math>\Phi</math></p> $\Phi = \frac{(x+y)}{2}$ 	Minor																														
		<p><b>A grade</b></p> <table border="1"> <thead> <tr> <th rowspan="2">area size (mm)</th> <th colspan="3">Most approve q'ty</th> </tr> <tr> <th>A</th> <th>B</th> <th>C</th> </tr> </thead> <tbody> <tr> <td><math>\Phi \leq 0.10</math></td> <td colspan="3">ignore</td> </tr> <tr> <td><math>0.10 &lt; \Phi \leq 0.15</math></td> <td colspan="3">3</td> </tr> <tr> <td><math>0.15 &lt; \Phi \leq 0.20</math></td> <td colspan="3">2</td> </tr> <tr> <td><math>0.20 &lt; \Phi \leq 0.3</math></td> <td colspan="3">1</td> </tr> <tr> <td><math>0.3 &lt; \Phi</math></td> <td colspan="3">0</td> </tr> </tbody> </table> <p>Most approve 4 damages, dot to dot <math>\geq 10\text{mm}</math></p>		area size (mm)	Most approve q'ty			A	B	C	$\Phi \leq 0.10$	ignore			$0.10 < \Phi \leq 0.15$	3			$0.15 < \Phi \leq 0.20$	2			$0.20 < \Phi \leq 0.3$	1			$0.3 < \Phi$	0					
area size (mm)	Most approve q'ty																																
	A	B	C																														
$\Phi \leq 0.10$	ignore																																
$0.10 < \Phi \leq 0.15$	3																																
$0.15 < \Phi \leq 0.20$	2																																
$0.20 < \Phi \leq 0.3$	1																																
$0.3 < \Phi$	0																																
4.2.2	Black or white line (power on)	<p><b>A grade</b></p> <table border="1"> <thead> <tr> <th colspan="2">Size(mm)</th> <th colspan="3">Most approve q'ty</th> </tr> <tr> <th>L(length)</th> <th>W(width)</th> <th>A</th> <th>B</th> <th>C</th> </tr> </thead> <tbody> <tr> <td>ignore</td> <td><math>W \leq 0.03</math></td> <td colspan="3">ignore</td> </tr> <tr> <td><math>L \leq 5.0</math></td> <td><math>0.03 &lt; W \leq 0.05</math></td> <td colspan="3">2</td> </tr> <tr> <td><math>L \leq 3.0</math></td> <td><math>0.05 &lt; W \leq 0.07</math></td> <td colspan="3">1</td> </tr> <tr> <td></td> <td><math>0.07 &lt; W</math></td> <td colspan="3">Treat with dot non-conformance</td> </tr> </tbody> </table> <p>Most approve 3 damages, line to line <math>\geq 10\text{mm}</math></p>	Size(mm)		Most approve q'ty			L(length)	W(width)	A	B	C	ignore	$W \leq 0.03$	ignore			$L \leq 5.0$	$0.03 < W \leq 0.05$	2			$L \leq 3.0$	$0.05 < W \leq 0.07$	1				$0.07 < W$	Treat with dot non-conformance			Minor
Size(mm)		Most approve q'ty																															
L(length)	W(width)	A	B	C																													
ignore	$W \leq 0.03$	ignore																															
$L \leq 5.0$	$0.03 < W \leq 0.05$	2																															
$L \leq 3.0$	$0.05 < W \leq 0.07$	1																															
	$0.07 < W$	Treat with dot non-conformance																															

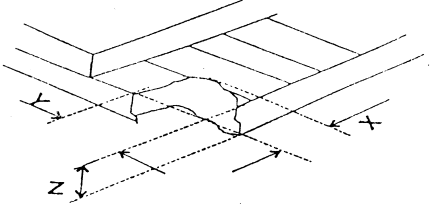
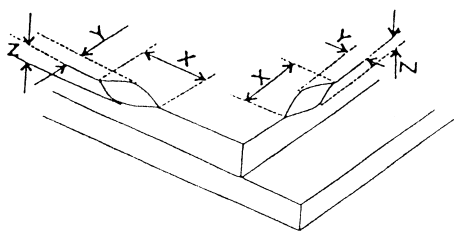
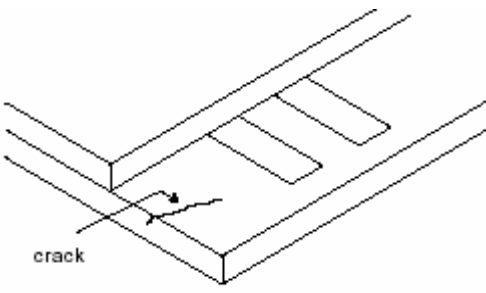
4.2.3	<b>Polarizer position</b>	1) polarizer attach meet drawing, disallow out of LCD. 2) polarizer must cover display area (special require unless)	<b>Minor</b>													
4.2.4	<b>LCD non-conformance</b>	<p>(i) crash at side (remark: S=ITO length)</p>  <table border="1" data-bbox="557 546 1192 642"> <thead> <tr> <th>X</th> <th>Y</th> <th>Z</th> </tr> </thead> <tbody> <tr> <td>≤3.0</td> <td>≤S</td> <td>ignore</td> </tr> </tbody> </table> <p>Crash disallow extend to ITO or seal.</p> <p>(ii) commonly surface scathe</p>  <table border="1" data-bbox="534 981 1214 1077"> <thead> <tr> <th>X</th> <th>Y</th> <th>Z</th> </tr> </thead> <tbody> <tr> <td>≤2.0</td> <td>&lt;frame edge</td> <td>ignore</td> </tr> </tbody> </table> <p>(iii) crack Disallow extend crack</p> 	X	Y	Z	≤3.0	≤S	ignore	X	Y	Z	≤2.0	<frame edge	ignore	<b>Minor</b>	
X	Y	Z														
≤3.0	≤S	ignore														
X	Y	Z														
≤2.0	<frame edge	ignore														
4.2.5	<b>Contrast voltage warp</b>	VOP/Vlcd voltage of confirmed sample ±0.15V	<b>Minor</b>													
4.2.6	<b>color</b>	Color & luminance of module scope reference spec	<b>Minor</b>													
4.2.7	<b>Cross talk</b>	Reference confirmed limit sample	<b>Minor</b>													

## 12. Handling Precautions

### 12.1 Mounting method

The LCD panel of SC LCD module consists of two thin glass plates with polarizes which easily be damaged. And since the module is so constructed as to be fixed by utilizing fitting holes in the printed circuit board.

Extreme care should be needed when handling the LCD modules.

### 12.2 Caution of LCD handling and cleaning

When cleaning the display surface, Use soft cloth with solvent [recommended below] and wipe lightly

- Isopropyl alcohol
- Ethyl alcohol

Do not wipe the display surface with dry or hard materials that will damage the polarizer surface.

Do not use the following solvent:

- Water
- Aromatics

Do not wipe ITO pad area with the dry or hard materials that will damage the ITO patterns

Do not use the following solvent on the pad or prevent it from being contaminated:

- Soldering flux
- Chlorine (Cl) , Sulfur (S)

If goods were sent without being silicon coated on the pad, ITO patterns could be damaged due to the corrosion as time goes on.

If ITO corrosion happens by miss-handling or using some materials such as Chlorine (Cl), Sulfur (S) from customer, Responsibility is on customer.

### 12.3 Caution against static charge

The LCD module uses C-MOS LSI drivers, so we recommend that you:

Connect any unused input terminal to Vdd or Vss, do not input any signals before power is turned on, and ground your body, work/assembly areas, assembly equipment to protect against static electricity.

### 12.4 packing

- Module employs LCD elements and must be treated as such.
- Avoid intense shock and falls from a height.
- To prevent modules from degradation, do not operate or store them exposed directly to sunshine or high temperature/humidity

### 12.5 Caution for operation

- It is an indispensable condition to drive LCD's within the specified voltage limit since the higher voltage than the limit causes the shorter LCD life.
- An electrochemical reaction due to direct current causes LCD's undesirable deterioration, so that the use of direct current drive should be avoided.
- Response time will be extremely delayed at lower temperature than the operating temperature range and on the other hand at higher temperature LCD's show dark color in them. However those phenomena do not mean malfunction or out of order with LCD's, which will come back in the specified operation temperature.
- If the display area is pushed hard during operation, some font will be abnormally displayed but it resumes normal condition after turning off once.
- A slight dew depositing on terminals is a cause for electro-chemical reaction resulting in terminal open circuit.

Usage under the maximum operating temperature, 50%Rh or less is required.

## 12.6 storage

In the case of storing for a long period of time for instance, for years for the purpose or replacement use, the following ways are recommended.

- Storage in a polyethylene bag with the opening sealed so as not to enter fresh air outside in it .  
And with no desiccant.
- Placing in a dark place where neither exposure to direct sunlight nor light's keeping the storage temperature range.
- Storing with no touch on polarizer surface by the anything else.  
[It is recommended to store them as they have been contained in the inner container at the time of delivery from us

## 12.7 Safety

- It is recommendable to crash damaged or unnecessary LCD's into pieces and wash off liquid crystal by either of solvents such as acetone and ethanol, which should be burned up later.
- When any liquid leaked out of a damaged glass cell comes in contact with your hands, please wash it off well with soap and water

## 13. Precaution For Use

### 13.1

A limit sample should be provided by the both parties on an occasion when the both parties agreed its necessity. Judgment by a limit sample shall take effect after the limit sample has been established and confirmed by the both parties.

### 13.2

On the following occasions, the handing of problem should be decided through discussion and agreement between responsible of the both parties.

- When a question is arisen in this specification
- When a new problem is arisen which is not specified in this specifications
- When an inspection specifications change or operating condition change in customer is reported to GT LCD , and some problem is arisen in this specification due to the change
- When a new problem is arisen at the customer's operating set for sample evaluation in the customer site.

## 14. Packing Method

**TBD**



## X-ON Electronics

Largest Supplier of Electrical and Electronic Components

*Click to view similar products for [Adafruit Accessories](#) category:*

*Click to view products by [Adafruit](#) manufacturer:*

Other Similar products are found below :

[3209](#) [3561](#) [3560](#) [3562](#) [2503](#) [3011](#) [3048](#) [2973](#) [2868](#) [2958](#) [2836](#) [2968](#) [3610](#) [3568](#) [3551](#) [2858](#) [3353](#) [3584](#) [3484](#) [2865](#) [3556](#) [3559](#) [3262](#)  
[3348](#) [2499](#) [2878](#) [2963](#) [3219](#) [3005](#) [2882](#) [PGM1202](#) [02-LDR1](#) [02-LDR12](#) [02-LDR13](#) [02-LDR14](#) [02-LDR15](#) [02-LDR2](#) [02-LDR3](#) [02-LDR4](#)  
[2194](#) [862](#) [460](#) [905](#) [02-LDR20](#) [02-LDR21](#) [02-LDR22](#) [02-LDR23](#) [1008](#) [1020](#) [1031](#)