

LM3671/-Q1 2-MHz, 600-mA Step-Down DC-DC Converter

1 Features

- 16- μ A Typical Quiescent Current
- 600-mA Maximum Load Capability
- 2-MHz PWM Fixed Switching Frequency (Typ.)
- Automatic PFM/PWM Mode Switching
- Internal Synchronous Rectification for High Efficiency
- Internal Soft Start
- 0.01- μ A Typical Shutdown Current
- Operates from a Single Li-Ion Cell Battery
- Only Three Tiny Surface-Mount External Components Required (One Inductor, Two Ceramic Capacitors)
- Current Overload and Thermal Shutdown Protection
- Available in Fixed Output Voltages and Adjustable Version
- LM3671-Q1 is an AEC-Q100 Grade 1 Qualified Automotive Grade Product

2 Applications

- Mobile Phones
- PDAs
- MP3 Players
- W-LAN
- Portable Instruments
- Digital Still Cameras
- Portable Hard Disk Drives
- Automotive

3 Description

The LM3671 step-down DC-DC converter is optimized for powering low voltage circuits from a single Li-Ion cell battery and input voltage rails from 2.7 V to 5.5 V. It provides up to 600-mA load current, over the entire input voltage range. There are several different fixed voltage output options available as well as an adjustable output voltage version range from 1.1 V to 3.3 V.

The device offers superior features and performance for mobile phones and similar portable systems. Automatic intelligent switching between PWM low-noise and PFM low-current mode offers improved system control. During PWM mode, the device operates at a fixed-frequency of 2 MHz (typ.). Hysteretic PFM mode extends the battery life by reducing the quiescent current to 16 μ A (typ.) during light load and standby operation. Internal synchronous rectification provides high efficiency during PWM mode operation. In shutdown mode, the device turns off and reduces battery consumption to 0.01 μ A (typ.).

A high-switching frequency of 2 MHz (typ.) allows use of tiny surface-mount components. Only three external surface-mount components, an inductor, and two ceramic capacitors, are required.

Device Information⁽¹⁾

PART NUMBER	PACKAGE	BODY SIZE
LM3671	USON (6)	2.00 mm x 2.00 mm (NOM)
LM3671	SOT-23 (5)	2.90 mm x 1.60 mm (NOM)
LM3671-Q1	DSBGA (5)	1.413 mm x 1.083 mm (MAX)

(1) For all available packages, see the orderable addendum at the end of the datasheet.

Typical Application Circuit: Fixed-Voltage

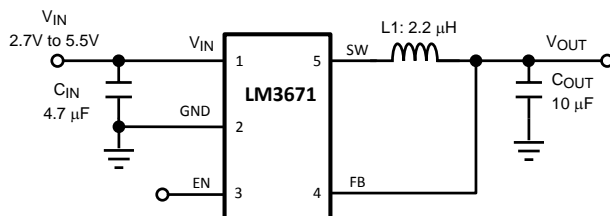

Typical Application Circuit: ADJ

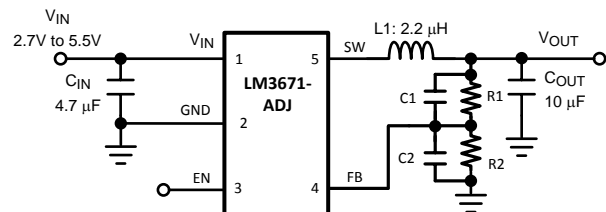

Table of Contents

1 Features	1	7.4 Device Functional Modes.....	13
2 Applications	1	8 Application and Implementation	16
3 Description	1	8.1 Application Information.....	16
4 Revision History	2	8.2 Typical Application	16
5 Pin Configuration and Functions	3	9 Power Supply Recommendations	21
6 Specifications	4	10 Layout	21
6.1 Absolute Maximum Ratings	4	10.1 Layout Guidelines	21
6.2 Handling Ratings: LM3671.....	4	10.2 Layout Example	22
6.3 Handling Ratings: LM3671-Q1.....	4	10.3 DSBGA Package Assembly and Use	22
6.4 Recommended Operating Conditions.....	5	11 Device and Documentation Support	23
6.5 Thermal Information	5	11.1 Device Support.....	23
6.6 Dissipation Ratings	5	11.2 Documentation Support	23
6.7 Electrical Characteristics.....	6	11.3 Related Links	23
6.8 Typical Characteristics.....	7	11.4 Trademarks	23
7 Detailed Description	12	11.5 Electrostatic Discharge Caution.....	23
7.1 Overview	12	11.6 Glossary	23
7.2 Functional Block Diagram	12	12 Mechanical, Packaging, and Orderable	23
7.3 Feature Description.....	13	Information	23

4 Revision History

NOTE: Page numbers for previous revisions may differ from page numbers in the current version.

Changes from Revision Q (November 2013) to Revision R	Page
<ul style="list-style-type: none"> Added <i>Device Information</i> and <i>Handling Rating</i> tables, <i>Feature Description</i>, <i>Device Functional Modes</i>, <i>Application and Implementation</i>, <i>Power Supply Recommendations</i>, <i>Layout</i>, <i>Device and Documentation Support</i>, and <i>Mechanical, Packaging, and Orderable Information</i> sections; moved some curves to <i>Application Curves</i> section 	1

Changes from Revision O (April 2013) to Revision P	Page
<ul style="list-style-type: none"> Changed layout of National Data Sheet to TI format 	22

5 Pin Configuration and Functions

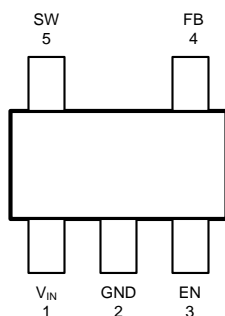
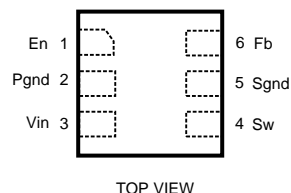
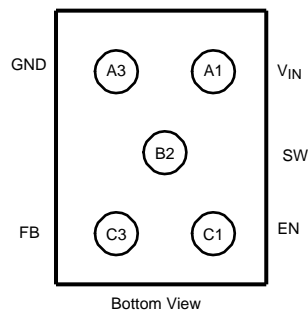
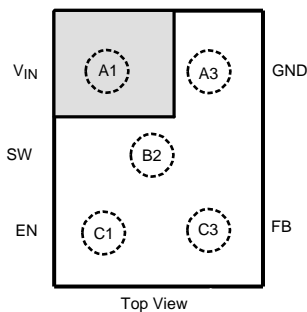
**5 Pins
SOT-23 Package (DBV)
Top View**

**6 Pins
USON Package (NKH)
TOP VIEW**

**DSBGA Package (YZR)
5 Pins**

Pin Functions

NAME	PIN			TYPE	DESCRIPTION
	LM3671, LM3671-Q1 SOT-23	LM3671 DSBGA	LM3671 USON		
V _{IN}	1	A1	3	Power	Power supply input. Connect to the input filter capacitor (see Input Capacitor Selection).
GND	2	A3	2	Ground	Ground pin.
EN	3	C1	1	Digital	Enable pin. The device is in shutdown mode when voltage to this pin is < 0.4 V and enabled when > 1 V. Do not leave this pin floating.
FB	4	C3	6	Analog	Feedback analog input. Connect directly to the output filter capacitor for fixed voltage versions. For adjustable version external resistor dividers are required (see Typical Application: ADJ Version). The internal resistor dividers are disabled for the adjustable version.
SW	5	B2	4	Analog	Switching node connection to the internal PFET switch and NFET synchronous rectifier.
S _{GND}	-	-	5	Ground	Signal ground (feedback ground).

6 Specifications

6.1 Absolute Maximum Ratings

 over operating free-air temperature range (unless otherwise noted) ⁽¹⁾⁽²⁾

	MIN	MAX	UNIT
V _{IN} pin: voltage to GND	-0.2	6	V
FB, SW, EN pins:	GND-0.2	V _{IN} + 0.2	V
Continuous power dissipation ⁽³⁾		Internally Limited	
Junction temperature (T _{J-MAX})		125	°C
Maximum lead temperature (soldering, 10 sec.)		260	°C

- (1) Stresses beyond those listed under *Absolute Maximum Ratings* may cause permanent damage to the device. These are stress ratings only, which do not imply functional operation of the device at these or any other conditions beyond those indicated under *Recommended Operating Conditions*. Exposure to absolute-maximum-rated conditions for extended periods may affect device reliability.
- (2) If Military/Aerospace specified devices are required, please contact the Texas Instruments Sales Office / Distributors for availability and specifications.
- (3) Internal thermal shutdown circuitry protects the device from permanent damage. Thermal shutdown engages at T_J = 150°C (typ.) and disengages at T_J = 130°C (typ.).

6.2 Handling Ratings: LM3671

	MIN	MAX	UNIT
T _{stg} Storage temperature range	-65	150	°C
V _(ESD) Electrostatic discharge	Human body model (HBM), per ANSI/ESDA/JEDEC JS-001, all pins ⁽¹⁾	2	kV
	Charged device model (CDM), per JEDEC specification JESD22-C101, all pins ⁽²⁾	0.5	
	Machine model	200	V

- (1) JEDEC document JEP155 states that 500-V HBM allows safe manufacturing with a standard ESD control process.
- (2) JEDEC document JEP157 states that 250-V CDM allows safe manufacturing with a standard ESD control process.

6.3 Handling Ratings: LM3671-Q1

	MIN	MAX	UNIT
T _{stg} Storage temperature range	-65	150	°C
V _(ESD) Electrostatic discharge	Human body model (HBM), per AEC Q100-002 ⁽¹⁾	2	kV
	Charged device model (CDM), per AEC Q100-011	Corner pins (1, 3, 4, and 5): SOT-23	
		Corner pins (A1, A3, C1, and C3): DSBGA	
	Machine model	200	V

- (1) AEC Q100-002 indicates HBM stressing is done in accordance with the ANSI/ESDA/JEDEC JS-001 specification.

6.4 Recommended Operating Conditions

over operating free-air temperature range (unless otherwise noted)⁽¹⁾⁽²⁾

	MIN	MAX	UNIT
Input voltage ⁽³⁾	2.7	5.5	V
Recommended load current	0	600	mA
Junction temperature (T _J)	–40	125	°C
Ambient temperature (T _A) ⁽⁴⁾	–40	85	°C

- (1) Stresses beyond those listed under *Absolute Maximum Ratings* may cause permanent damage to the device. These are stress ratings only, which do not imply functional operation of the device at these or any other conditions beyond those indicated under *Recommended Operating Conditions*. Exposure to absolute-maximum-rated conditions for extended periods may affect device reliability.
- (2) All voltages are with respect to the potential at the GND pin.
- (3) The input voltage range recommended for ideal applications performance for the specified output voltages are given below: V_{IN} = 2.7 V to 4.5 V for 1.1 V ≤ V_{OUT} < 1.5 V, V_{IN} = 2.7 V to 5.5 V for 1.5 V ≤ V_{OUT} < 1.8 V, V_{IN} = (V_{OUT} + V_{DROPOUT}) to 5.5 V for 1.8 V ≤ V_{OUT} ≤ 3.3 V where V_{DROPOUT} = I_{LOAD} × (R_{DS(on), PFET} + R_{INDUCTOR}).
- (4) In applications where high power dissipation and/or poor package resistance is present, the maximum ambient temperature may have to be derated. Maximum ambient temperature (T_{A-MAX}) is dependent on the maximum operating junction temperature (T_{J-MAX}), the maximum power dissipation of the device in the application (P_{D-MAX}) and the junction to ambient thermal resistance of the package (R_{θJA}) in the application, as given by the following equation: T_{A-MAX} = T_{J-MAX} – (R_{θJA} × P_{D-MAX}). Refer to [Dissipation Ratings](#) for P_{D-MAX} values at different ambient temperatures.

6.5 Thermal Information

THERMAL METRIC ⁽¹⁾	LM3671	LM3671 and LM3671-Q1		UNIT
	USON (NKH)	SOT-23 (DBV)	DSBGA (YZR)	
	6 PINS	5 PINS	5 PINS	
R _{θJA} Junction-to-ambient thermal resistance	165	130	85	°C/W

- (1) For more information about traditional and new thermal metrics, see the *IC Package Thermal Metrics* application report, [SPRA953](#).

6.6 Dissipation Ratings

R _{θJA}	T _A ≤ 25°C POWER RATING	T _A = 60°C POWER RATING	T _A = 85°C POWER RATING
130°C/W (4 layer board) SOT-23	770 mW	500 mW	310 mW
85°C/W (4 layer board) 5-bump DSBGA	1179 mW	765 mW	470 mW
165°C/W (4 layer board) 6-pin USON	606 mW	394 mW	242 mW

6.7 Electrical Characteristics

Unless otherwise noted, limits apply for for $T_J = 25^\circ\text{C}$, and specifications apply to the LM3671MF/TL/LC with $V_{IN} = EN = 3.6$ V⁽¹⁾⁽²⁾⁽³⁾

PARAMETER		TEST CONDITION	MIN	TYP	MAX	UNIT
V_{IN}	Input voltage	-40°C to 125°C , see ⁽⁴⁾	2.7		5.5	V
V_{FB}	Feedback voltage (fixed) MF	PWM mode ⁽⁵⁾ , -40°C to 125°C	-4%		4%	
	Feedback voltage (fixed) TL		-2.5%		2.5%	
	Feedback voltage (fixed) LC		-4%		4%	
	Feedback voltage (ADJ) MF ⁽⁶⁾	PWM mode ⁽⁵⁾ , -40°C to 125°C	-4%		4%	
	Feedback voltage (ADJ) TL		-2.5		2.5	
	Line regulation	$2.7\text{ V} \leq V_{IN} \leq 5.5\text{ V}$, $I_O = 10\text{ mA}$		0.031		%/V
	Load regulation	$100\text{ mA} \leq I_O \leq 600\text{ mA}$, $V_{IN} = 3.6\text{ V}$		0.0013		%/mA
V_{REF}	Internal reference voltage			0.5		V
I_{SHDN}	Shutdown supply current	$EN = 0\text{ V}$		0.01		μA
		$EN = 0\text{ V}$, -40°C to 125°C			1	
I_Q	DC Bias Current into V_{IN}	No load, device is not switching (FB forced higher than programmed output voltage)		16		μA
		No load, device is not switching (FB forced higher than programmed output voltage), -40°C to 125°C			35	
$R_{DSON(P)}$	Pin-pin resistance for PFET	$V_{IN} = V_{GS} = 3.6\text{ V}$		380	500	m Ω
$R_{DSON(N)}$	Pin-pin resistance for NFET	$V_{IN} = V_{GS} = 3.6\text{ V}$		250	400	m Ω
I_{LIM}	Switch peak current limit	Open loop ⁽⁷⁾		1020		mA
		Open loop ⁽⁷⁾ , -40°C to 125°C	830		1150	
V_{IH}	Logic high input	-40°C to 125°C	1			V
V_{IL}	Logic low input	-40°C to 125°C			0.4	V
I_{EN}	Enable (EN) input current			0.01		μA
		-40°C to 125°C			1	
F_{OSC}	Internal oscillator frequency	PWM Mode ⁽⁵⁾		2		MHz
		PWM Mode ⁽⁵⁾ , -40°C to 125°C	1.6		2.6	

- (1) Min and Max limits are specified by design, test or statistical analysis. Typical numbers are not specified, but do represent the most likely norm.
- (2) The parameters in the electrical characteristic table are tested at $V_{IN} = 3.6\text{ V}$ unless otherwise specified. For performance over the input voltage range refer to datasheet curves.
- (3) Internal thermal shutdown circuitry protects the device from permanent damage. Thermal shutdown engages at $T_J = 150^\circ\text{C}$ (typ.) and disengages at $T_J = 130^\circ\text{C}$ (typ.).
- (4) The input voltage range recommended for ideal applications performance for the specified output voltages are given below: $V_{IN} = 2.7\text{ V}$ to 4.5 V for $1.1\text{ V} \leq V_{OUT} < 1.5\text{ V}$ $V_{IN} = 2.7\text{ V}$ to 5.5 V for $1.5\text{ V} \leq V_{OUT} < 1.8\text{ V}$ $V_{IN} = (V_{OUT} + V_{DROPOUT})$ to 5.5 V for $1.8\text{ V} \leq V_{OUT} \leq 3.3\text{ V}$ where $V_{DROPOUT} = I_{LOAD} \times (R_{DSON, PFET} + R_{INDUCTOR})$.
- (5) Test condition: for V_{OUT} less than 2.5 V , $V_{IN} = 3.6\text{ V}$; for V_{OUT} greater than or equal to 2.5 V , $V_{IN} = V_{OUT} + 1\text{ V}$.
- (6) ADJ version is configured to 1.5 V output. For ADJ output version: $V_{IN} = 2.7\text{ V}$ to 4.5 V for $0.90\text{ V} \leq V_{OUT} < 1.1\text{ V}$ $V_{IN} = 2.7\text{ V}$ to 5.5 V for $1.1\text{ V} \leq V_{OUT} < 3.3\text{ V}$
- (7) Refer to [Typical Characteristics](#) for closed loop data and its variation with regards to supply voltage and temperature. Electrical Characteristic table reflects open loop data (FB = 0 V and current drawn from SW pin ramped up until cycle by cycle current limit is activated). Closed loop current limit is the peak inductor current measured in the application circuit by increasing output current until output voltage drops by 10%.

6.8 Typical Characteristics

LM3671MF/TL/LC, Circuit of *Typical Application Circuit: Fixed-Voltage*, $V_{IN} = 3.6\text{ V}$, $V_{OUT} = 1.5\text{ V}$, $T_A = 25^\circ\text{C}$, unless otherwise noted.

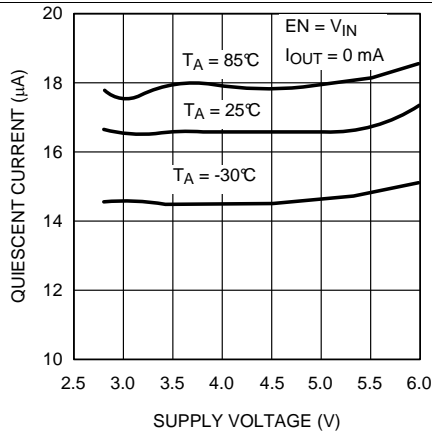

Figure 1. Quiescent Supply Current vs. Supply Voltage

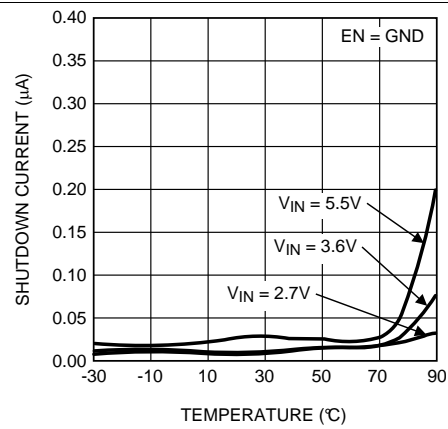

Figure 2. Shutdown Current vs. Temp

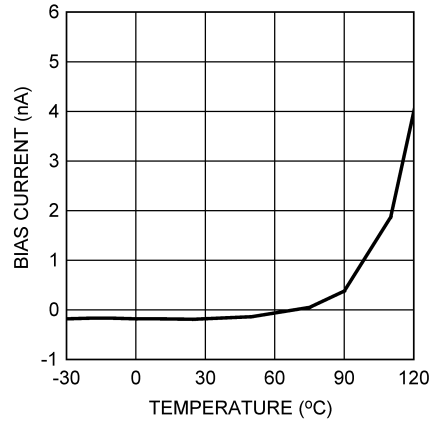

Figure 3. Feedback Bias Current vs. Temp

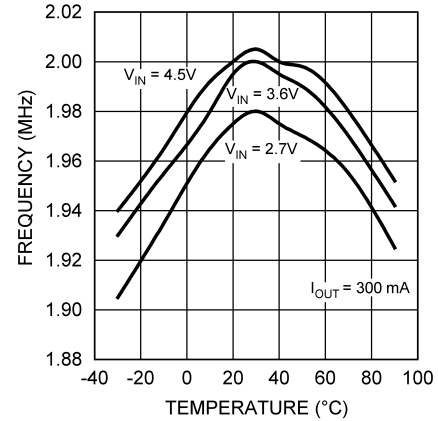

Figure 4. Switching Frequency vs. Temperature

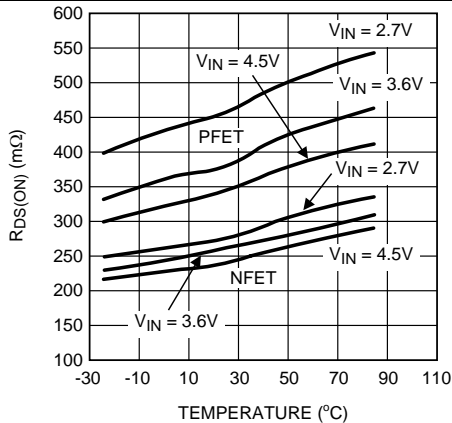

Figure 5. $R_{DS(ON)}$ vs. Temperature

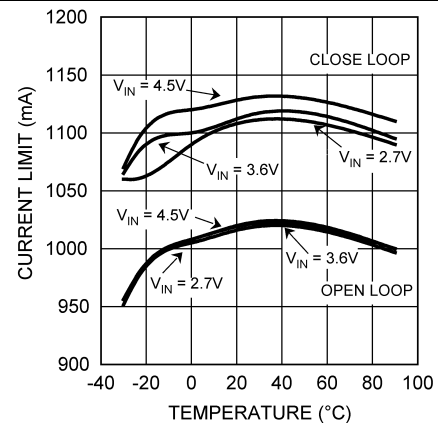

Figure 6. Open/Closed Loop Current Limit vs. Temperature

Typical Characteristics (continued)

LM3671MF/TL/LC, Circuit of *Typical Application Circuit: Fixed-Voltage*, $V_{IN} = 3.6\text{ V}$, $V_{OUT} = 1.5\text{ V}$, $T_A = 25^\circ\text{C}$, unless otherwise noted.

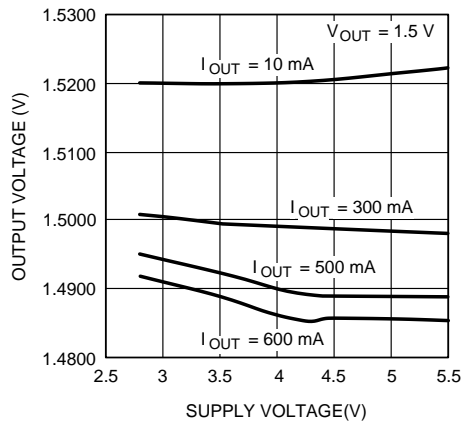

Figure 7. Output Voltage vs. Supply Voltage)

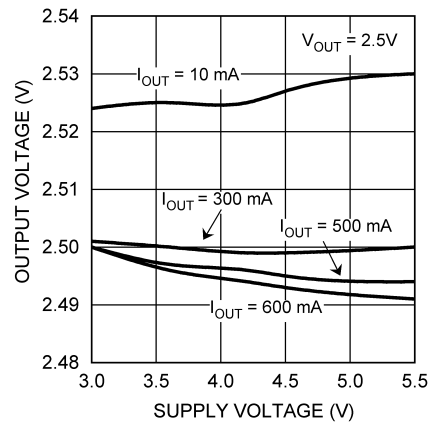

Figure 8. Output Voltage vs. Supply Voltage

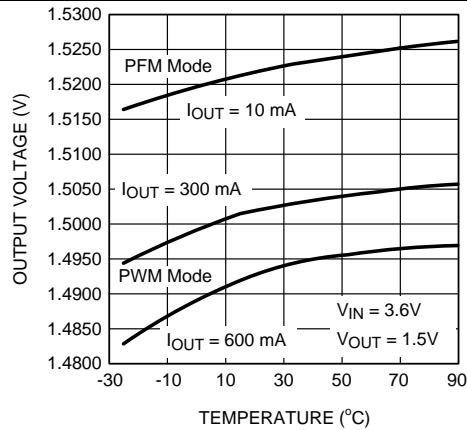

Figure 9. Output Voltage vs. Temperature

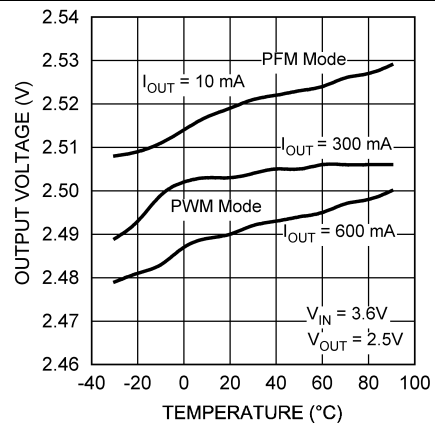

Figure 10. Output Voltage vs. Temperature

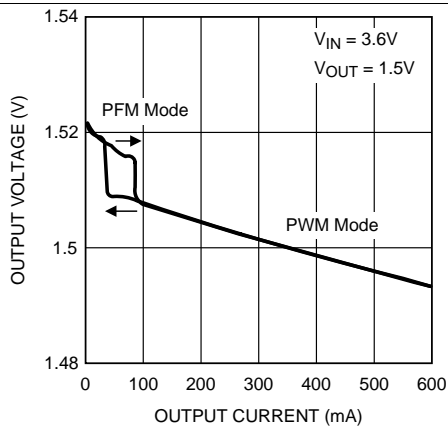

Figure 11. Output Voltage vs. Output Current

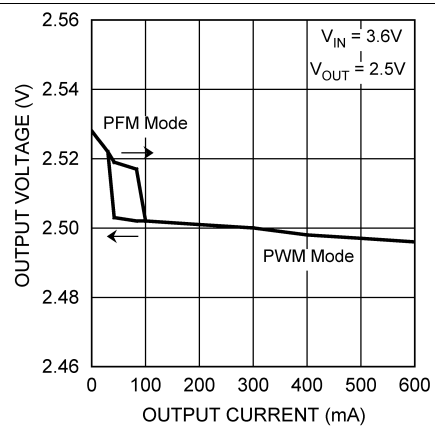

Figure 12. Output Voltage vs. Output Current

Typical Characteristics (continued)

LM3671MF/TL/LC, Circuit of *Typical Application Circuit: Fixed-Voltage*, $V_{IN} = 3.6\text{ V}$, $V_{OUT} = 1.5\text{ V}$, $T_A = 25^\circ\text{C}$, unless otherwise noted.

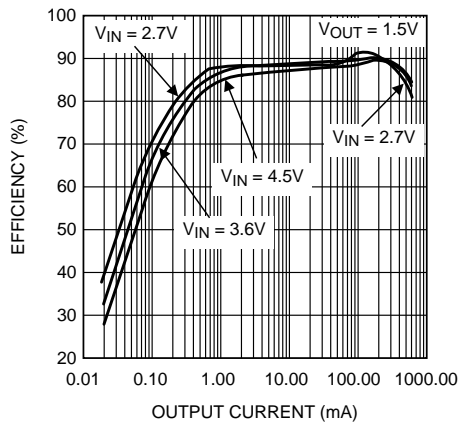

Figure 13. Efficiency vs. Output Current

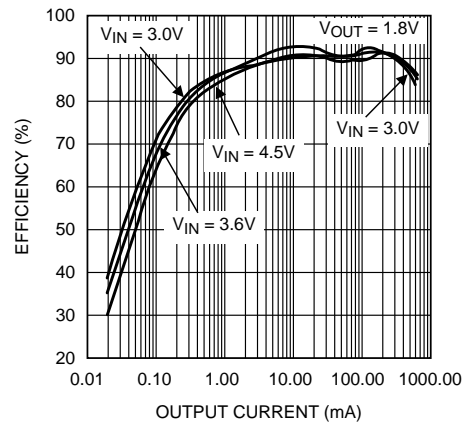

Figure 14. Efficiency vs. Output Current

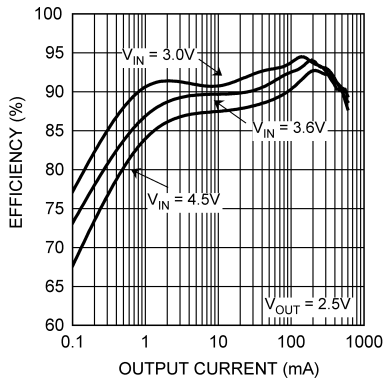

Figure 15. Efficiency vs. Output Current

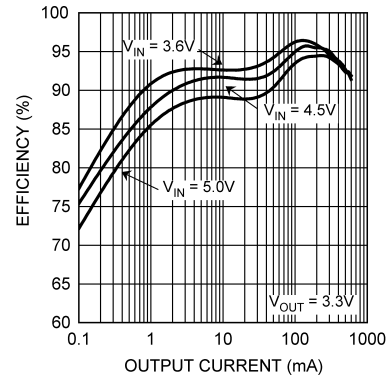

Figure 16. Efficiency vs. Output Current

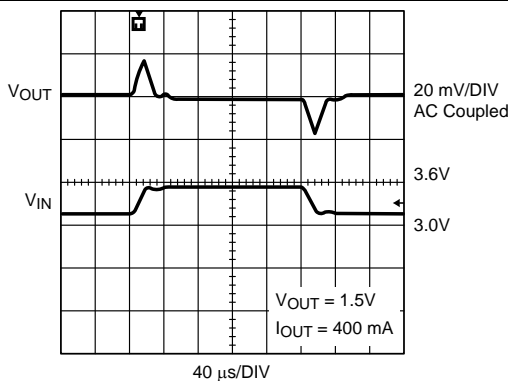

Figure 17. Line Transient Response (PWM Mode)

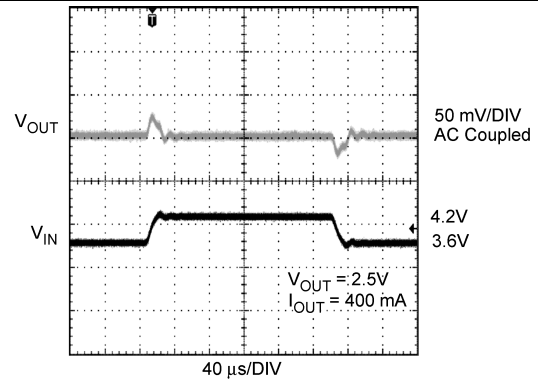
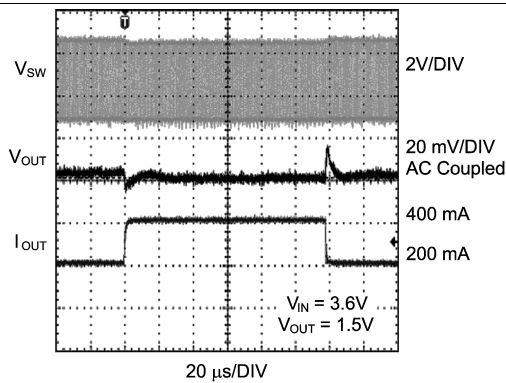
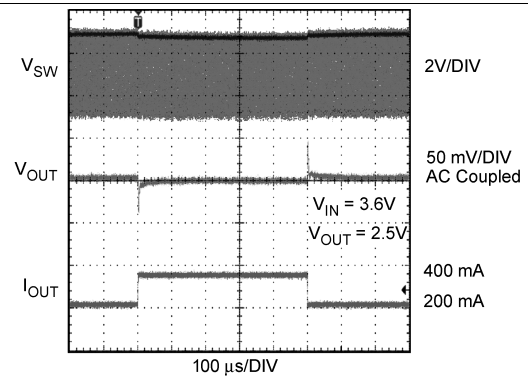
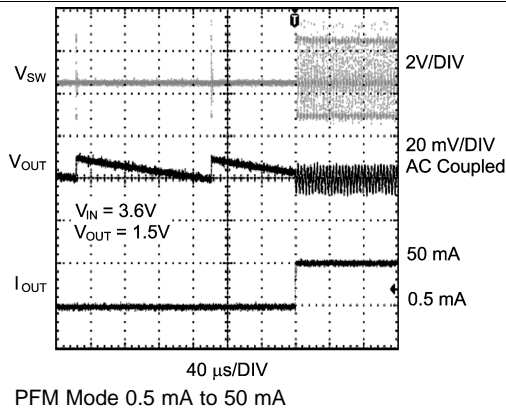
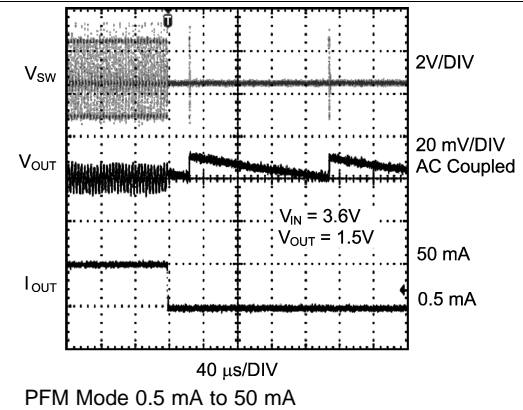
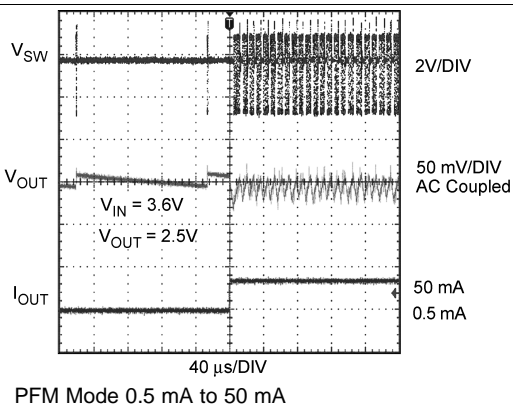
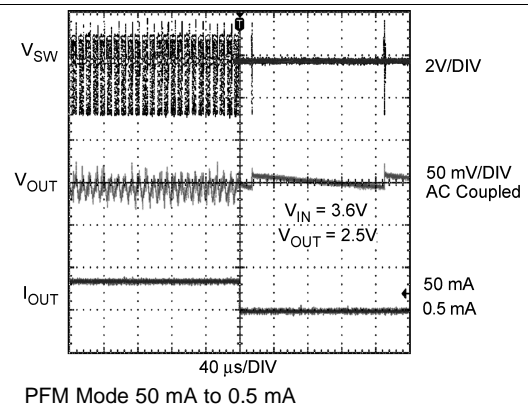

Figure 18. Line Transient Response (PWM Mode)

Typical Characteristics (continued)

 LM3671MF/TL/LC, Circuit of *Typical Application Circuit: Fixed-Voltage*, $V_{IN} = 3.6\text{ V}$, $V_{OUT} = 1.5\text{ V}$, $T_A = 25^\circ\text{C}$, unless otherwise noted.

Figure 19. Load Transient Response (PWM Mode)

Figure 20. Load Transient Response (PWM Mode)

Figure 21. Load Transient Response

Figure 22. Load Transient Response

Figure 23. Load Transient Response

Figure 24. Load Transient Response

Typical Characteristics (continued)

LM3671MF/TL/LC, Circuit of *Typical Application Circuit: Fixed-Voltage*, $V_{IN} = 3.6\text{ V}$, $V_{OUT} = 1.5\text{ V}$, $T_A = 25^\circ\text{C}$, unless otherwise noted.

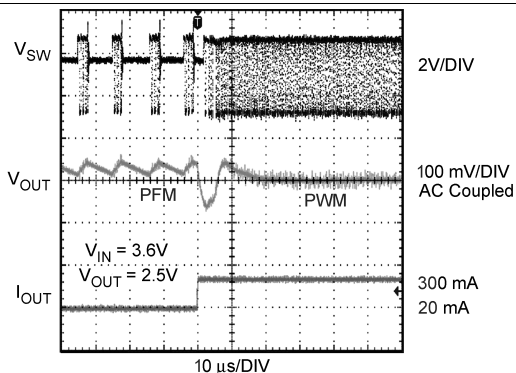

Figure 25. PFM to PWM Mode Change by Load Transients

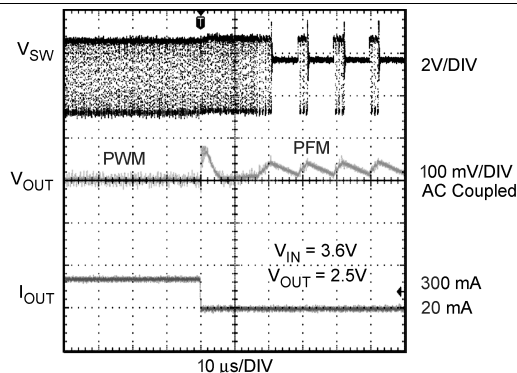

Figure 26. PWM to PFM Mode Change by Load Transients

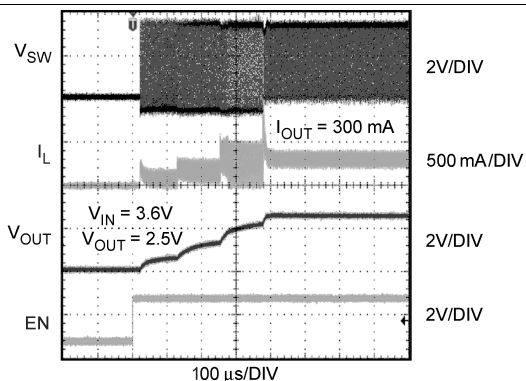

Figure 27. Start-Up into PWM Mode

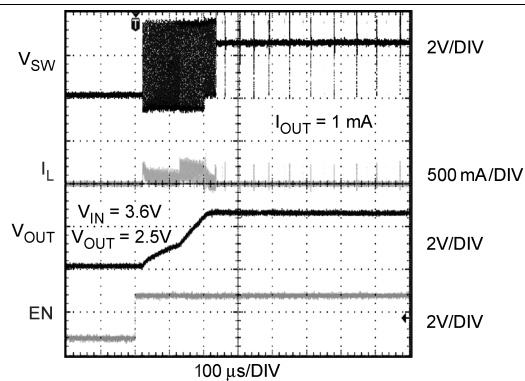

Figure 28. Start-Up into PFM Mode

7 Detailed Description

7.1 Overview

The LM3671, a high-efficiency step-down DC-DC switching buck converter, delivers a constant voltage from a single Li-Ion battery and input voltage rails from 2.7 V to 5.5 V to portable devices such as cell phones and PDAs. Using a voltage mode architecture with synchronous rectification, the LM3671 has the ability to deliver up to 600 mA depending on the input voltage, output voltage, ambient temperature and the inductor chosen.

There are three modes of operation depending on the current required: PWM (Pulse Width Modulation), PFM (Pulse Frequency Modulation), and shutdown. The device operates in PWM mode at load current of approximately 80 mA or higher. Lighter load current cause the device to automatically switch into PFM for reduced current consumption ($I_Q = 16 \mu\text{A}$ typ) and a longer battery life. Shutdown mode turns off the device, offering the lowest current consumption ($I_{\text{SHUTDOWN}} = 0.01 \mu\text{A}$ typ).

Additional features include soft-start, undervoltage protection, current overload protection, and thermal shutdown protection. As shown in the [Typical Application Circuit: Fixed-Voltage](#), only three external power components are required for implementation.

The part uses an internal reference voltage of 0.5 V. It is recommended to keep the part in shutdown until the input voltage is 2.7 V or higher.

7.2 Functional Block Diagram

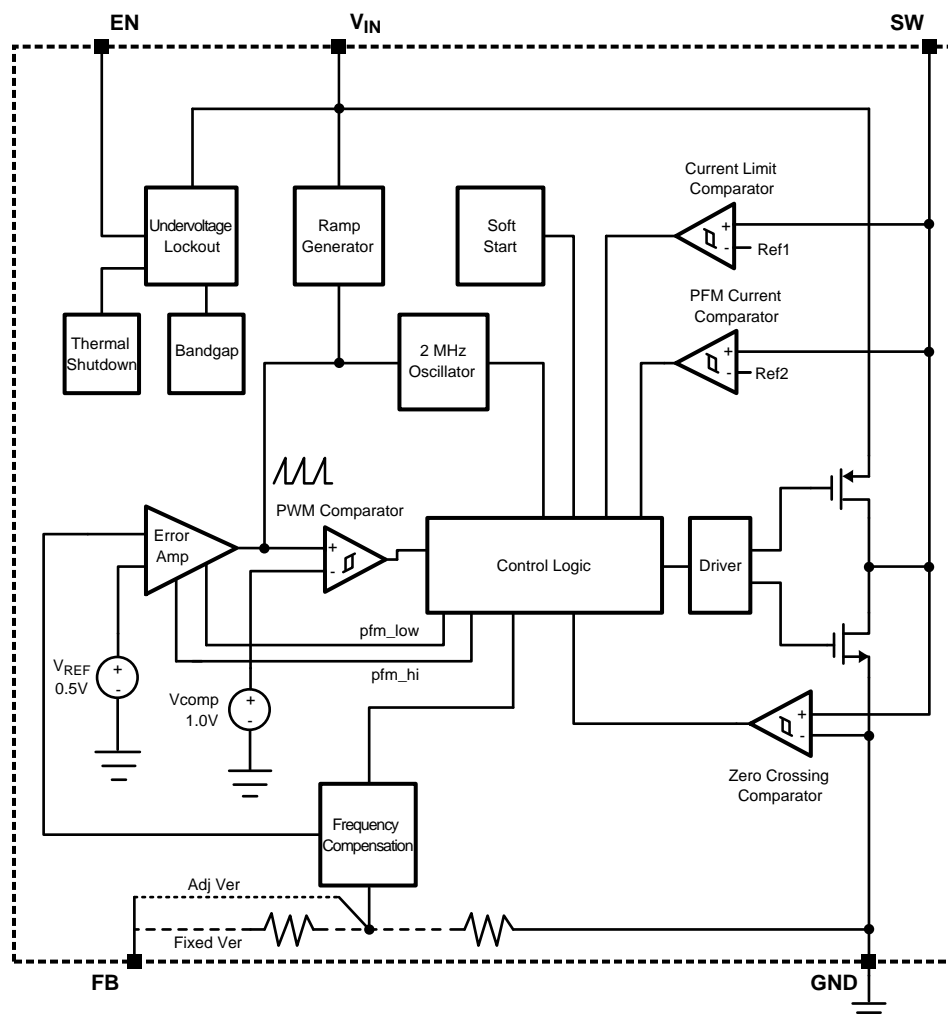

7.3 Feature Description

7.3.1 Circuit Operation

During the first portion of each switching cycle, the control block in the LM3671 turns on the internal PFET switch. This allows current to flow from the input through the inductor to the output filter capacitor and load. The inductor limits the current to a ramp with a slope of $(V_{IN} - V_{OUT})/L$, by storing energy in a magnetic field.

During the second portion of each cycle, the controller turns the PFET switch off, blocking current flow from the input, and then turns the NFET synchronous rectifier on. The inductor draws current from ground through the NFET to the output filter capacitor and load, which ramps the inductor current down with a slope of $-V_{OUT}/L$.

The output filter stores charge when the inductor current is high, and releases it when inductor current is low, smoothing the voltage across the load.

The output voltage is regulated by modulating the PFET switch on time to control the average current sent to the load. The effect is identical to sending a duty-cycle modulated rectangular wave formed by the switch and synchronous rectifier at the SW pin to a low-pass filter formed by the inductor and output filter capacitor. The output voltage is equal to the average voltage at the SW pin.

7.3.2 Soft Start

The LM3671 has a soft-start circuit that limits in-rush current during start-up. During start-up the switch current limit is increased in steps. Soft start is activated only if EN goes from logic low to logic high after V_{IN} reaches 2.7 V. Soft start is implemented by increasing switch current limit in steps of 70 mA, 140 mA, 280 mA and 1020 mA (typical switch current limit). The start-up time thereby depends on the output capacitor and load current demanded at startup. Typical start-up times with a 10- μ F output capacitor and 300-mA load is 400 μ s and with 1-mA load is 275 μ s.

7.4 Device Functional Modes

7.4.1 PWM Operation

During PWM operation the converter operates as a voltage-mode controller with input voltage feed forward. This allows the converter to achieve good load and line regulation. The DC gain of the power stage is proportional to the input voltage. To eliminate this dependence, feed forward inversely proportional to the input voltage is introduced.

While in PWM mode, the output voltage is regulated by switching at a constant frequency and then modulating the energy per cycle to control power to the load. At the beginning of each clock cycle the PFET switch is turned on and the inductor current ramps up until the comparator trips and the control logic turns off the switch. The current limit comparator can also turn off the switch in case the current limit of the PFET is exceeded. Then the NFET switch is turned on and the inductor current ramps down. The next cycle is initiated by the clock turning off the NFET and turning on the PFET.

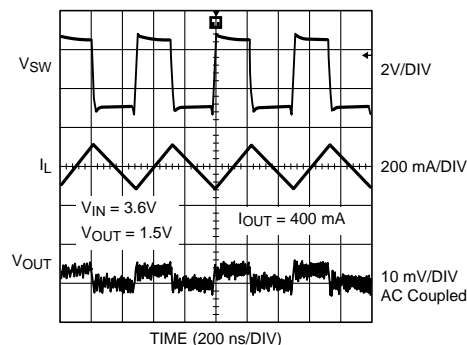

Figure 29. Typical PWM Operation

Device Functional Modes (continued)

7.4.1.1 Internal Synchronous Rectification

While in PWM mode, the LM3671 uses an internal NFET as a synchronous rectifier to reduce rectifier forward voltage drop and associated power loss. Synchronous rectification provides a significant improvement in efficiency whenever the output voltage is relatively low compared to the voltage drop across an ordinary rectifier diode.

7.4.1.2 Current Limiting

A current limit feature allows the LM3671 to protect itself and external components during overload conditions. PWM mode implements current limiting using an internal comparator that trips at 1020 mA (typ.). If the output is shorted to ground the device enters a timed current limit mode where the NFET is turned on for a longer duration until the inductor current falls below a low threshold. This allows the inductor current more time to decay, thereby preventing runaway.

7.4.2 PFM Operation

At very light load, the converter enters PFM mode and operates with reduced switching frequency and supply current to maintain high efficiency.

The part automatically transitions into PFM mode when either of two conditions occurs for a duration of 32 or more clock cycles:

1. The NFET current reaches zero.
2. The peak PMOS switch current drops below the I_{MODE} level, (Typically $I_{MODE} < 30 \text{ mA} + V_{IN}/42 \Omega$).

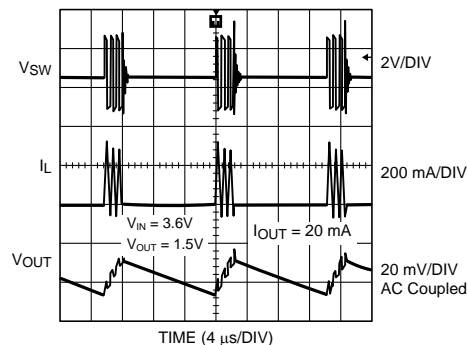

Figure 30. Typical PFM Operation

During PFM operation, the converter positions the output voltage slightly higher than the nominal output voltage during PWM operation, allowing additional headroom for voltage drop during a load transient from light to heavy load. The PFM comparators sense the output voltage via the feedback pin and control the switching of the output FETs such that the output voltage ramps between approximately 0.6% and 1.7% above the nominal PWM output voltage. If the output voltage is below the 'high' PFM comparator threshold, the PMOS power switch is turned on. It remains on until the output voltage reaches the 'high' PFM threshold or the peak current exceeds the I_{PFM} level set for PFM mode. The typical peak current in PFM mode is: $I_{PFM} = 112 \text{ mA} + V_{IN}/27 \Omega$.

Once the PMOS power switch is turned off, the NMOS power switch is turned on until the inductor current ramps to zero. When the NMOS zero-current condition is detected, the NMOS power switch is turned off. If the output voltage is below the 'high' PFM comparator threshold (see [Figure 31](#)), the PMOS switch is again turned on and the cycle is repeated until the output reaches the desired level. Once the output reaches the 'high' PFM threshold, the NMOS switch is turned on briefly to ramp the inductor current to zero and then both output switches are turned off and the part enters an extremely low power mode. Quiescent supply current during this 'sleep' mode is 16 μA (typ.), which allows the part to achieve high efficiency under extremely light load conditions.

Device Functional Modes (continued)

If the load current should increase during PFM mode (see Figure 31) causing the output voltage to fall below the 'low2' PFM threshold, the part will automatically transition into fixed-frequency PWM mode. When $V_{IN} = 2.7\text{ V}$ the part transitions from PWM to PFM mode at approximately 35 mA output current and from PFM to PWM mode at approximately 85 mA, when $V_{IN} = 3.6\text{ V}$, PWM to PFM transition happens at approximately 50 mA and PFM to PWM transition happens at ~100 mA, when $V_{IN} = 4.5\text{ V}$, PWM to PFM transition happens at approximately 65 mA and PFM to PWM transition happens at approximately 115 mA.

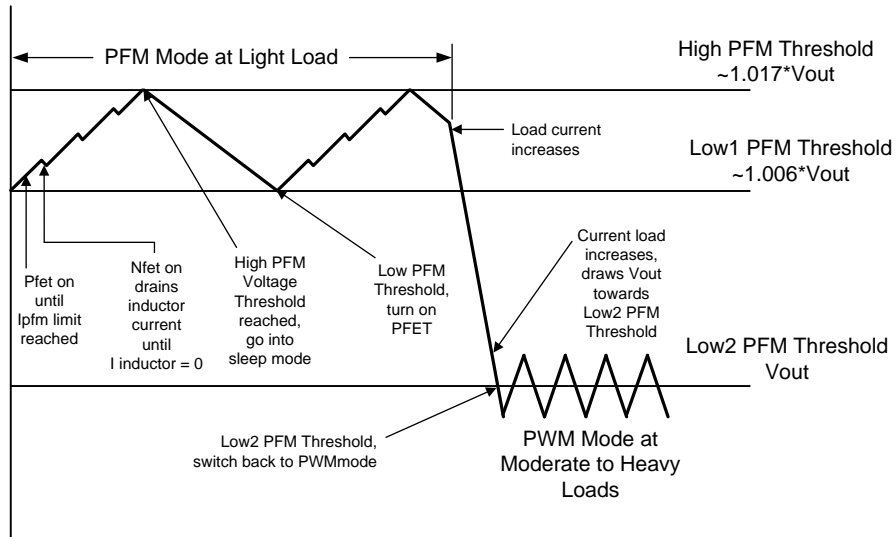

Figure 31. Operation in PFM Mode and Transfer to PWM Mode

7.4.3 Shutdown

Setting the EN input pin low ($< 0.4\text{ V}$) places the LM3671 in shutdown mode. During shutdown the PFET switch, NFET switch, reference, control and bias circuitry of the LM3671 are turned off. Setting EN high ($> 1\text{ V}$) enables normal operation. It is recommended to set EN pin low to turn off the LM3671 during system power up and undervoltage conditions when the supply is less than 2.7 V. Do not leave the EN pin floating.

7.4.4 LDO - Low Dropout Operation

The LM3671-ADJ can operate at 100% duty cycle (no switching; PMOS switch completely on) for low dropout support of the output voltage. In this way the output voltage will be controlled down to the lowest possible input voltage. When the device operates near 100% duty cycle, output voltage ripple is approximately 25 mV.

The minimum input voltage needed to support the output voltage is

$$V_{IN, MIN} = I_{LOAD} * (R_{DSON, PFET} + R_{INDUCTOR}) + V_{OUT}$$

where

- I_{LOAD} : Load current
- $R_{DSON, PFET}$: Drain to source resistance of PFET switch in the triode region
- $R_{INDUCTOR}$: Inductor resistance

(1)

8 Application and Implementation

NOTE

Information in the following applications sections is not part of the TI component specification, and TI does not warrant its accuracy or completeness. TI's customers are responsible for determining suitability of components for their purposes. Customers should validate and test their design implementation to confirm system functionality.

8.1 Application Information

The external control of this device is very easy. First make sure the correct voltage been applied at VIN pin, then simply apply the voltage at EN pin according to the [Electrical Characteristics](#) to enable or disable the output voltage.

8.2 Typical Application

8.2.1 Typical Application: Fixed-Voltage Version

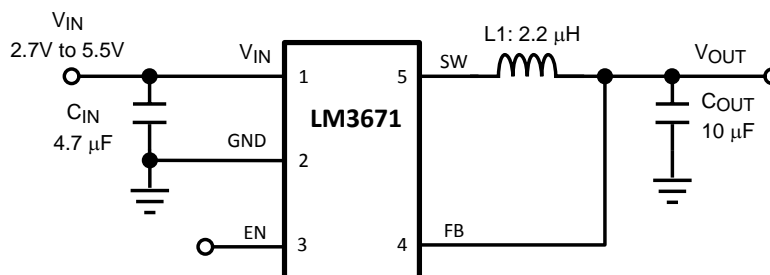

Figure 32. LM3671 Fixed-Voltage Typical Application Circuit

8.2.1.1 Design Requirements

Two ceramic capacitors and one inductor required for this application. These three external components need to be selected very carefully for property operation. Please read [Detailed Design Procedure](#).

8.2.1.2 Detailed Design Procedure

8.2.1.2.1 Inductor Selection

There are two main considerations when choosing an inductor; the inductor should not saturate, and the inductor current ripple should be small enough to achieve the desired output voltage ripple. Different saturation current rating specifications are followed by different manufacturers so attention must be given to details. Saturation current ratings are typically specified at 25°C. However, ratings at the maximum ambient temperature of application should be requested from the manufacturer. **The minimum value of inductance to specify good performance is 1.76 µH at I_{LIM} (typ.) DC current over the ambient temperature range.** Shielded inductors radiate less noise and should be preferred.

There are two methods to choose the inductor saturation current rating.

8.2.1.2.1.1 Method 1

The saturation current should be greater than the sum of the maximum load current and the worst case average to peak inductor current. This can be written as

$$I_{SAT} > I_{OUTMAX} + I_{RIPPLE}$$

$$\text{where } I_{RIPPLE} = \left(\frac{V_{IN} - V_{OUT}}{2 * L} \right) * \left(\frac{V_{OUT}}{V_{IN}} \right) * \left(\frac{1}{f} \right)$$

where

- I_{RIPPLE} : average to peak inductor current

Typical Application (continued)

- I_{OUTMAX} : maximum load current (600 mA)
 - V_{IN} : maximum input voltage in application
 - L : min inductor value including worst case tolerances (30% drop can be considered for method 1)
 - f : minimum switching frequency (1.6 MHz)
 - V_{OUT} : output voltage
- (2)

8.2.1.2.1.2 Method 2

A more conservative and recommended approach is to choose an inductor that has a saturation current rating greater than the maximum current limit of 1150 mA.

A 2.2- μ H inductor with a saturation current rating of at least 1150 mA is recommended for most applications. Inductor resistance should be less than 0.3 Ω for good efficiency. [Table 1](#) lists suggested inductors and suppliers. For low-cost applications, an unshielded bobbin inductor could be considered. For noise critical applications, a toroidal or shielded-bobbin inductor should be used. A good practice is to lay out the board with overlapping footprints of both types for design flexibility. This allows substitution of a low-noise shielded inductor, in the event that noise from low-cost bobbin models is unacceptable.

8.2.1.2.2 Input Capacitor Selection

A ceramic input capacitor of 4.7 μ F, 6.3 V is sufficient for most applications. Place the input capacitor as close as possible to the V_{IN} pin of the device. A larger value may be used for improved input voltage filtering. Use X7R or X5R types; do not use Y5V. DC bias characteristics of ceramic capacitors must be considered when selecting case sizes like 0805 and 0603. **The minimum input capacitance to specify good performance is 2.2 μ F at 3-V DC bias; 1.5 μ F at 5-V DC bias including tolerances and over ambient temperature range.** The input filter capacitor supplies current to the PFET switch of the LM3671 in the first half of each cycle and reduces voltage ripple imposed on the input power source. A ceramic capacitor's low ESR provides the best noise filtering of the input voltage spikes due to this rapidly changing current. Select a capacitor with sufficient ripple current rating. The input current ripple can be calculated as:

$$I_{RMS} = I_{OUTMAX} * \sqrt{\frac{V_{OUT}}{V_{IN}} * \left(1 - \frac{V_{OUT}}{V_{IN}} + \frac{r^2}{12}\right)}$$

$$r = \frac{(V_{IN} - V_{OUT}) * V_{OUT}}{L * f * I_{OUTMAX} * V_{IN}}$$

The worst case is when $V_{IN} = 2 * V_{OUT}$ (3)

Table 1. Suggested Inductors and Their Suppliers

MODEL	VENDOR	DIMENSIONS LxWxH (mm)	D.C.R (max)
DO3314-222MX	Coilcraft	3.3 x 3.3 x 1.4	200 m Ω
LPO3310-222MX	Coilcraft	3.3 x 3.3 x 1.0	150 m Ω
ELL5GM2R2N	Panasonic	5.2 x 5.2 x 1.5	53 m Ω
CDRH2D14NP-2R2NC	Sumida	3.2 x 3.2 x 1.55	94 m Ω

8.2.1.2.3 Output Capacitor Selection

A ceramic output capacitor of 10 μ F, 6.3 V is sufficient for most applications. Use X7R or X5R types; do not use Y5V. DC bias characteristics of ceramic capacitors must be considered when selecting case sizes like 0805 and 0603. DC bias characteristics vary from manufacturer to manufacturer and dc bias curves should be requested from them as part of the capacitor selection process.

The minimum output capacitance to specify good performance is 5.75 μ F at 1.8-V DC bias including tolerances and over ambient temperature range. The output filter capacitor smoothes out current flow from the inductor to the load, helps maintain a steady output voltage during transient load changes and reduces output voltage ripple. These capacitors must be selected with sufficient capacitance and sufficiently low ESR to perform these functions.

The output voltage ripple is caused by the charging and discharging of the output capacitor and by the R_{ESR} and can be calculated as:

Voltage peak-to-peak ripple due to capacitance can be expressed by [Equation 4](#):

$$V_{PP-C} = \frac{I_{RIPPLE}}{4 * f * C} \quad (4)$$

Voltage peak-to-peak ripple due to ESR can be expressed by [Equation 5](#):

$$V_{PP-ESR} = (2 * I_{RIPPLE}) * R_{ESR} \quad (5)$$

Because these two components are out of phase the rms (root mean squared) value can be used to get an approximate value of peak-to-peak ripple.

The peak-to-peak ripple voltage, rms value can be expressed by [Equation 6](#):

$$V_{PP-RMS} = \sqrt{V_{PP-C}^2 + V_{PP-ESR}^2} \quad (6)$$

Note that the output voltage ripple is dependent on the inductor current ripple and the equivalent series resistance of the output capacitor (R_{ESR}).

The R_{ESR} is frequency dependent (as well as temperature dependent); make sure the value used for calculations is at the switching frequency of the part.

Table 2. Suggested Capacitors and Their Suppliers

MODEL	TYPE	VENDOR	VOLTAGE RATING	CASE SIZE INCH (mm)
4.7 μF for C_{IN}				
C2012X5R0J475K	Ceramic, X5R	TDK	6.3 V	0805 (2012)
JMK212BJ475K	Ceramic, X5R	Taiyo-Yuden	6.3 V	0805 (2012)
GRM21BR60J475K	Ceramic, X5R	Murata	6.3 V	0805 (2012)
C1608X5R0J475K	Ceramic, X5R	TDK	6.3 V	0603 (1608)
10 μF for C_{OUT}				
GRM21BR60J106K	Ceramic, X5R	Murata	6.3 V	0805 (2012)
JMK212BJ106K	Ceramic, X5R	Taiyo-Yuden	6.3 V	0805 (2012)
C2012X5R0J106K	Ceramic, X5R	TDK	6.3 V	0805 (2012)
C1608X5R0J106K	Ceramic, X5R	TDK	6.3 V	0603 (1608)

8.2.1.3 Application Curves

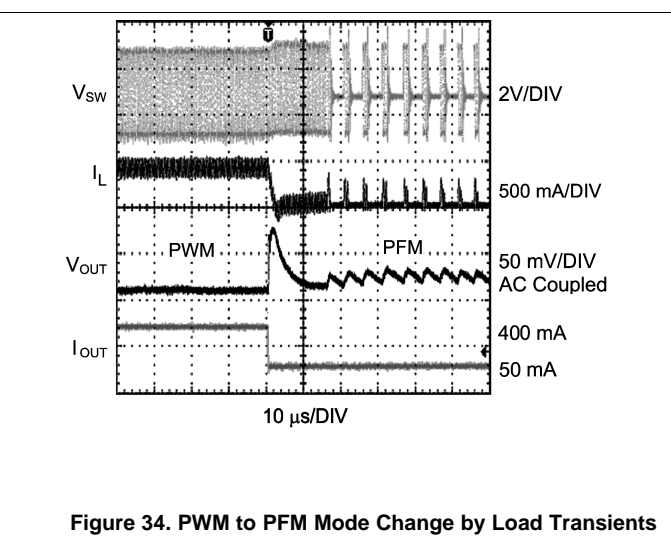
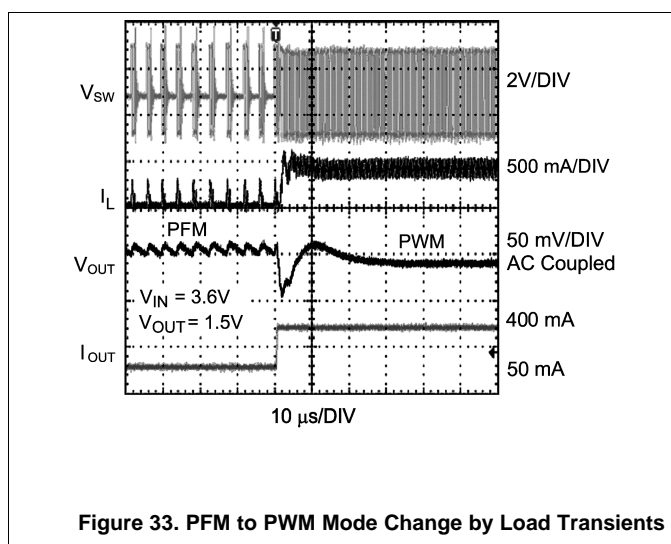

8.2.2 Typical Application: ADJ Version

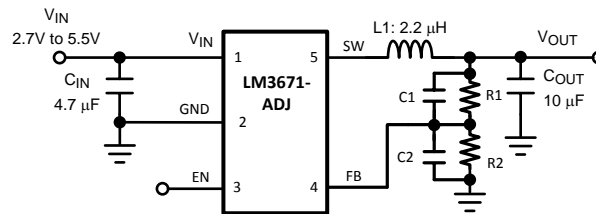

Figure 35. Typical Application Circuit for ADJ Version

8.2.2.1 Design Requirements

DESIGN PARAMETER	EXAMPLE VALUE
Input voltage range	2.7 V to 5.5 V
Input capacitor	4.7 µF
Output capacitor	10 µF
Inductor	2.2 µH
ADJ programmable output voltage	1.1 V to 3.3 V

8.2.2.2 Detailed Design Procedure

8.2.2.2.1 Output Voltage Selection for LM3671-ADJ

The output voltage of the adjustable parts can be programmed through the resistor network connected from V_{OUT} to FB, then to GND. V_{OUT} is adjusted to make the voltage at FB equal to 0.5 V. The resistor from FB to GND (R2) should be 200 kΩ to keep the current drawn through this network well below the 16-µA quiescent current level (PFM mode) but large enough that it is not susceptible to noise. If R2 is 200 kΩ, and V_{FB} is 0.5 V, the current through the resistor feedback network will be 2.5 µA. The output voltage of the adjustable parts ranges from 1.1 V to 3.3 V.

The formula for output voltage selection is:

$$V_{OUT} = V_{FB} * \left(1 + \frac{R1}{R2} \right)$$

where

- V_{OUT} : output voltage (volts)
- V_{FB} : feedback voltage = 0.5 V
- R1: feedback resistor from V_{OUT} to FB
- R2: feedback resistor from FB to GND

(7)

For any output voltage greater than or equal to 1.1 V, a zero must be added around 45 kHz for stability. The formula for calculation of C1 is:

$$C1 = \frac{1}{(2 * \pi * R1 * 45 \text{ kHz})}$$

(8)

For output voltages higher than 2.5 V, a pole must be placed at 45 kHz as well. If the pole and zero are at the same frequency the formula for calculation of C2 is:

$$C2 = \frac{1}{(2 * \pi * R2 * 45 \text{ kHz})}$$

(9)

The formula for location of zero and pole frequency created by adding C1 and C2 is given below. By adding C1, a zero as well as a higher frequency pole is introduced.

$$Fz = \frac{1}{(2 * \pi * R1 * C1)}$$

(10)

$$Fp = \frac{1}{2 * \pi * (R1 || R2) * (C1 + C2)}$$

(11)

See the [Table 3](#) table.

Table 3. LM3671-ADJ Configurations for Various V_{OUT}
(Circuit of [Figure 35](#))

$V_{OUT}(V)$	R1(k Ω)	R2 (k Ω)	C1 (pF)	C2 (pF)	L (μ H)	C _{IN} (μ F)	C _{OUT} (μ F)
0.90	160	200	22	none	2.2	4.7	10
1.1	240	200	15	none	2.2	4.7	10
1.2	280	200	12	none	2.2	4.7	10
1.3	320	200	12	none	2.2	4.7	10
1.5	357	178	10	none	2.2	4.7	10
1.6	442	200	8.2	none	2.2	4.7	10
1.7	432	178	8.2	none	2.2	4.7	10
1.8	464	178	8.2	none	2.2	4.7	10
1.875	523	191	6.8	none	2.2	4.7	10
2.5	402	100	8.2	none	2.2	4.7	10
2.8	464	100	8.2	33	2.2	4.7	10
3.3	562	100	6.8	33	2.2	4.7	10

8.2.2.3 Application Curves

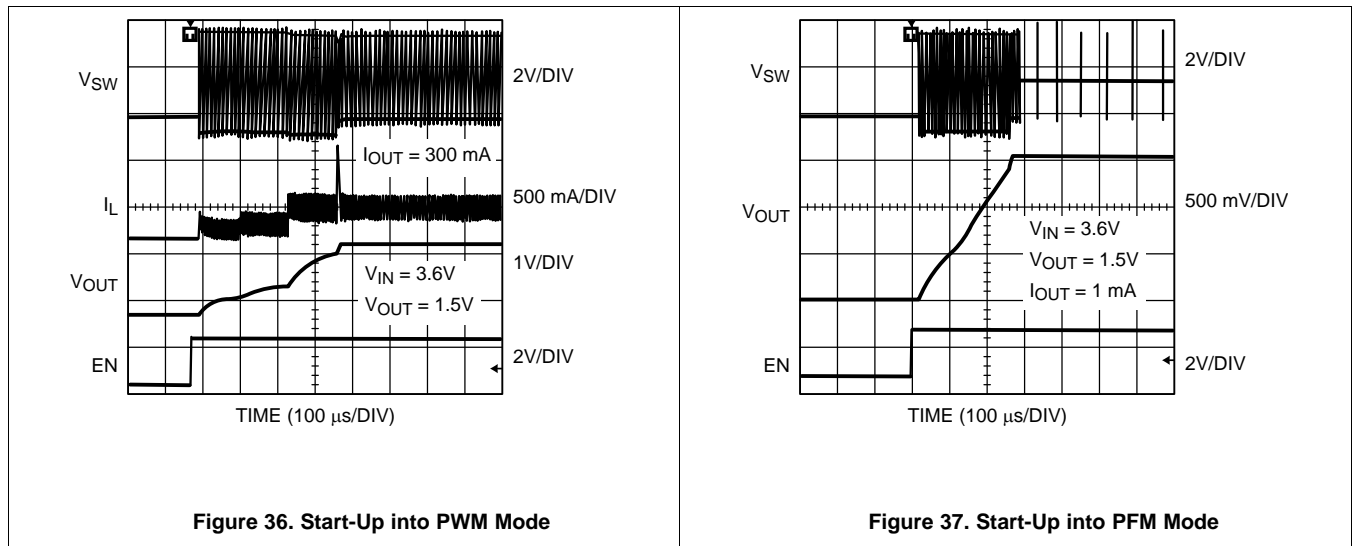

9 Power Supply Recommendations

The LM3671 is designed to operate from a stable input supply range of 2.7 V to 5.5 V.

10 Layout

10.1 Layout Guidelines

PC board layout is an important part of DC-DC converter design. Poor board layout can disrupt the performance of a DC-DC converter and surrounding circuitry by contributing to EMI, ground bounce, and resistive voltage loss in the traces. These can send erroneous signals to the DC-DC converter IC, resulting in poor regulation or instability.

Good layout for the LM3671 can be implemented by following a few simple design rules below. Refer to [Figure 38](#) for top layer board layout.

1. *Place the LM3671, inductor and filter capacitors close together and make the traces short.* The traces between these components carry relatively high switching currents and act as antennas. Following this rule reduces radiated noise. Special care must be given to place the input filter capacitor very close to the V_{IN} and GND pin.
2. *Arrange the components so that the switching current loops curl in the same direction.* During the first half of each cycle, current flows from the input filter capacitor through the LM3671 and inductor to the output filter capacitor and back through ground, forming a current loop. In the second half of each cycle, current is pulled up from ground through the LM3671 by the inductor to the output filter capacitor and then back through ground forming a second current loop. Routing these loops so the current curls in the same direction prevents magnetic field reversal between the two half-cycles and reduces radiated noise.
3. *Connect the ground pins of the LM3671 and filter capacitors together using generous component-side copper fill as a pseudo-ground plane. Then, connect this to the ground-plane (if one is used) with several vias.* This reduces ground-plane noise by preventing the switching currents from circulating through the ground plane. It also reduces ground bounce at the LM3671 by giving it a low-impedance ground connection.
4. *Use wide traces between the power components and for power connections to the DC-DC converter circuit.* This reduces voltage errors caused by resistive losses across the traces.
5. *Route noise sensitive traces, such as the voltage feedback path, away from noisy traces between the power components.* The voltage feedback trace must remain close to the LM3671 circuit and should be direct but should be routed opposite to noisy components. This reduces EMI radiated onto the DC-DC converter's own voltage feedback trace. A good approach is to route the feedback trace on another layer and to have a ground plane between the top layer and layer on which the feedback trace is routed. In the same manner for the adjustable part it is desired to have the feedback dividers on the bottom layer.
6. *Place noise sensitive circuitry, such as radio IF blocks, away from the DC-DC converter, CMOS digital blocks and other noisy circuitry.* Interference with noise-sensitive circuitry in the system can be reduced through distance.

In mobile phones, for example, a common practice is to place the DC-DC converter on one corner of the board, arrange the CMOS digital circuitry around it (since this also generates noise), and then place sensitive preamplifiers and IF stages on the diagonally opposing corner. Often, the sensitive circuitry is shielded with a metal pan and power to it is post-regulated to reduce conducted noise, using low-dropout linear regulators.

10.2 Layout Example

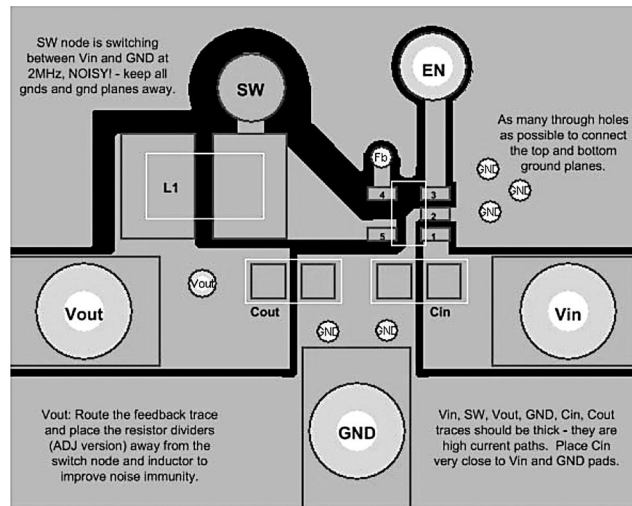

Figure 38. Top Layer Board Layout for SOT-23

10.3 DSBGA Package Assembly and Use

Use of the DSBGA package requires specialized board layout, precision mounting and careful re-flow techniques, as detailed in Texas Instruments *AN-1112 DSBGA Wafer Level Chip Scale Package (SNVA009)*. Refer to the section "Surface Mount Technology (DSBGA) Assembly Considerations". For best results in assembly, alignment ordinals on the PC board should be used to facilitate placement of the device. The pad style used with DSBGA package must be the NSMD (non-solder mask defined) type. This means that the solder-mask opening is larger than the pad size. This prevents a lip that otherwise forms if the solder-mask and pad overlap, from holding the device off the surface of the board and interfering with mounting. See *AN-1112 DSBGA Wafer Level Chip Scale Package (SNVA009)* for specific instructions how to do this. The 5-bump package used for LM3671 has 300 micron solder balls and requires 10.82 mils pads for mounting on the circuit board. The trace to each pad should enter the pad with a 90° entry angle to prevent debris from being caught in deep corners. Initially, the trace to each pad should be 7 mil wide, for a section approximately 7 mil long or longer, as a thermal relief. Then each trace should neck up or down to its optimal width. The important criteria is symmetry. This ensures the solder bumps on the LM3671 re-flow evenly and that the device solders level to the board. In particular, special attention must be paid to the pads for bumps A1 and A3, because V_{IN} and GND are typically connected to large copper planes, inadequate thermal relief can result in late or inadequate re-flow of these bumps.

The DSBGA package is optimized for the smallest possible size in applications with red or infrared opaque cases. Because the DSBGA package lacks the plastic encapsulation characteristic of larger devices, it is vulnerable to light. Backside metallization and/or epoxy coating, along with front-side shading by the printed circuit board, reduce this sensitivity. However, the package has exposed die edges. In particular, DSBGA devices are sensitive to light, in the red and infrared range, shining on the package's exposed die edges.

11 Device and Documentation Support

11.1 Device Support

11.1.1 Third-Party Products Disclaimer

TI'S PUBLICATION OF INFORMATION REGARDING THIRD-PARTY PRODUCTS OR SERVICES DOES NOT CONSTITUTE AN ENDORSEMENT REGARDING THE SUITABILITY OF SUCH PRODUCTS OR SERVICES OR A WARRANTY, REPRESENTATION OR ENDORSEMENT OF SUCH PRODUCTS OR SERVICES, EITHER ALONE OR IN COMBINATION WITH ANY TI PRODUCT OR SERVICE.

11.2 Documentation Support

11.2.1 Related Documentation

AN-1112 DSBGA Wafer Level Chip Scale Package ([SNVA009](#)).

11.3 Related Links

[Table 4](#) lists quick access links. Categories include technical documents, support and community resources, tools and software, and quick access to sample or buy.

Table 4. Related Links

PARTS	PRODUCT FOLDER	SAMPLE & BUY	TECHNICAL DOCUMENTS	TOOLS & SOFTWARE	SUPPORT & COMMUNITY
LM3671	Click here	Click here	Click here	Click here	Click here
LM3671-Q1	Click here	Click here	Click here	Click here	Click here

11.4 Trademarks

All trademarks are the property of their respective owners.

11.5 Electrostatic Discharge Caution



These devices have limited built-in ESD protection. The leads should be shorted together or the device placed in conductive foam during storage or handling to prevent electrostatic damage to the MOS gates.

11.6 Glossary

[SLYZ022](#) — *TI Glossary*.

This glossary lists and explains terms, acronyms, and definitions.

12 Mechanical, Packaging, and Orderable Information

The following pages include mechanical, packaging, and orderable information. This information is the most current data available for the designated devices. This data is subject to change without notice and revision of this document. For browser-based versions of this data sheet, refer to the left-hand navigation.



www.ti.com

PACKAGE

PACKAGING INFORMATION

Orderable Device	Status (1)	Package Type	Package Drawing	Pins	Package Qty	Eco Plan (2)	Lead/Ball Finish (6)	MSL Peak Temp (3)	Op Te
LM3671LC-1.2/NOPB	ACTIVE	USON	NKH	6	1000	Green (RoHS & no Sb/Br)	CU NIPDAU	Level-1-260C-UNLIM	
LM3671LC-1.3/NOPB	ACTIVE	USON	NKH	6	1000	Green (RoHS & no Sb/Br)	CU NIPDAU	Level-1-260C-UNLIM	
LM3671LC-1.6/NOPB	ACTIVE	USON	NKH	6	1000	Green (RoHS & no Sb/Br)	CU NIPDAU	Level-1-260C-UNLIM	
LM3671LC-1.8/NOPB	ACTIVE	USON	NKH	6	1000	Green (RoHS & no Sb/Br)	CU NIPDAU	Level-1-260C-UNLIM	
LM3671MF-1.2	NRND	SOT-23	DBV	5	1000	TBD	Call TI	Call TI	-30
LM3671MF-1.2/NOPB	ACTIVE	SOT-23	DBV	5	1000	Green (RoHS & no Sb/Br)	CU SN	Level-1-260C-UNLIM	-30
LM3671MF-1.25/NOPB	ACTIVE	SOT-23	DBV	5	1000	Green (RoHS & no Sb/Br)	CU SN	Level-1-260C-UNLIM	-30
LM3671MF-1.375/NOPB	ACTIVE	SOT-23	DBV	5	1000	Green (RoHS & no Sb/Br)	CU SN	Level-1-260C-UNLIM	-30
LM3671MF-1.5/NOPB	ACTIVE	SOT-23	DBV	5	1000	Green (RoHS & no Sb/Br)	CU SN	Level-1-260C-UNLIM	-30
LM3671MF-1.6/NOPB	ACTIVE	SOT-23	DBV	5	1000	Green (RoHS & no Sb/Br)	CU SN	Level-1-260C-UNLIM	-30
LM3671MF-1.8/NOPB	ACTIVE	SOT-23	DBV	5	1000	Green (RoHS & no Sb/Br)	CU SN	Level-1-260C-UNLIM	-30
LM3671MF-1.875/NOPB	ACTIVE	SOT-23	DBV	5	1000	Green (RoHS & no Sb/Br)	CU SN	Level-1-260C-UNLIM	-30
LM3671MF-2.5/NOPB	ACTIVE	SOT-23	DBV	5	1000	Green (RoHS & no Sb/Br)	CU SN	Level-1-260C-UNLIM	-30
LM3671MF-2.8	NRND	SOT-23	DBV	5	1000	TBD	Call TI	Call TI	-30
LM3671MF-2.8/NOPB	ACTIVE	SOT-23	DBV	5	1000	Green (RoHS & no Sb/Br)	CU SN	Level-1-260C-UNLIM	-30
LM3671MF-3.3/NOPB	ACTIVE	SOT-23	DBV	5	1000	Green (RoHS & no Sb/Br)	CU SN	Level-1-260C-UNLIM	-30
LM3671MF-ADJ/NOPB	ACTIVE	SOT-23	DBV	5	1000	Green (RoHS & no Sb/Br)	CU SN	Level-1-260C-UNLIM	-30
LM3671MFX-1.2/NOPB	ACTIVE	SOT-23	DBV	5	3000	Green (RoHS & no Sb/Br)	CU SN	Level-1-260C-UNLIM	-30



www.ti.com

PACKAGE

Orderable Device	Status (1)	Package Type	Package Drawing	Pins	Package Qty	Eco Plan (2)	Lead/Ball Finish (6)	MSL Peak Temp (3)	Op Te
LM3671MFX-1.25/NOPB	ACTIVE	SOT-23	DBV	5	3000	Green (RoHS & no Sb/Br)	CU SN	Level-1-260C-UNLIM	-30
LM3671MFX-1.8/NOPB	ACTIVE	SOT-23	DBV	5	3000	Green (RoHS & no Sb/Br)	CU SN	Level-1-260C-UNLIM	-30
LM3671MFX-1.875/NOPB	ACTIVE	SOT-23	DBV	5	3000	Green (RoHS & no Sb/Br)	CU SN	Level-1-260C-UNLIM	-30
LM3671MFX-2.5/NOPB	ACTIVE	SOT-23	DBV	5	3000	Green (RoHS & no Sb/Br)	CU SN	Level-1-260C-UNLIM	-30
LM3671MFX-2.8/NOPB	ACTIVE	SOT-23	DBV	5	3000	Green (RoHS & no Sb/Br)	CU SN	Level-1-260C-UNLIM	-30
LM3671MFX-3.3/NOPB	ACTIVE	SOT-23	DBV	5	3000	Green (RoHS & no Sb/Br)	CU SN	Level-1-260C-UNLIM	-30
LM3671MFX-ADJ/NOPB	ACTIVE	SOT-23	DBV	5	3000	Green (RoHS & no Sb/Br)	CU SN	Level-1-260C-UNLIM	-30
LM3671QMF-1.2/NOPB	ACTIVE	SOT-23	DBV	5	1000	Green (RoHS & no Sb/Br)	CU SN	Level-1-260C-UNLIM	-40 t
LM3671QMF-1.2/NOPB	ACTIVE	SOT-23	DBV	5	3000	Green (RoHS & no Sb/Br)	CU SN	Level-1-260C-UNLIM	-40 t
LM3671QTL-1.8/NOPB	ACTIVE	DSBGA	YZR	5	250	Green (RoHS & no Sb/Br)	SNAGCU	Level-1-260C-UNLIM	-40 t
LM3671QTLX-1.8/NOPB	ACTIVE	DSBGA	YZR	5	3000	Green (RoHS & no Sb/Br)	SNAGCU	Level-1-260C-UNLIM	-40 t
LM3671TL-1.2/NOPB	ACTIVE	DSBGA	YZR	5	250	Green (RoHS & no Sb/Br)	SNAGCU	Level-1-260C-UNLIM	-30
LM3671TL-1.5/NOPB	ACTIVE	DSBGA	YZR	5	250	Green (RoHS & no Sb/Br)	SNAGCU	Level-1-260C-UNLIM	-30
LM3671TL-1.8/NOPB	ACTIVE	DSBGA	YZR	5	250	Green (RoHS & no Sb/Br)	SNAGCU	Level-1-260C-UNLIM	-30
LM3671TL-2.5/NOPB	ACTIVE	DSBGA	YZR	5	250	Green (RoHS & no Sb/Br)	SNAGCU	Level-1-260C-UNLIM	-30
LM3671TL-2.8/NOPB	ACTIVE	DSBGA	YZR	5	250	Green (RoHS & no Sb/Br)	SNAGCU	Level-1-260C-UNLIM	-30
LM3671TL-3.3/NOPB	ACTIVE	DSBGA	YZR	5	250	Green (RoHS & no Sb/Br)	SNAGCU	Level-1-260C-UNLIM	-30
LM3671TL-ADJ/NOPB	ACTIVE	DSBGA	YZR	5	250	Green (RoHS & no Sb/Br)	SNAGCU	Level-1-260C-UNLIM	-30



www.ti.com

PACKAGE

Orderable Device	Status (1)	Package Type	Package Drawing	Pins	Package Qty	Eco Plan (2)	Lead/Ball Finish (6)	MSL Peak Temp (3)	Op Te
LM3671TLX-1.2/NOPB	ACTIVE	DSBGA	YZR	5	3000	Green (RoHS & no Sb/Br)	SNAGCU	Level-1-260C-UNLIM	-30
LM3671TLX-1.5/NOPB	ACTIVE	DSBGA	YZR	5	3000	Green (RoHS & no Sb/Br)	SNAGCU	Level-1-260C-UNLIM	-30
LM3671TLX-1.8/NOPB	ACTIVE	DSBGA	YZR	5	3000	Green (RoHS & no Sb/Br)	SNAGCU	Level-1-260C-UNLIM	-30
LM3671TLX-1.875/NOPB	ACTIVE	DSBGA	YZR	5	3000	Green (RoHS & no Sb/Br)	SNAGCU	Level-1-260C-UNLIM	-30
LM3671TLX-2.5/NOPB	ACTIVE	DSBGA	YZR	5	3000	Green (RoHS & no Sb/Br)	SNAGCU	Level-1-260C-UNLIM	-30
LM3671TLX-2.8/NOPB	ACTIVE	DSBGA	YZR	5	3000	Green (RoHS & no Sb/Br)	SNAGCU	Level-1-260C-UNLIM	-30
LM3671TLX-3.3/NOPB	ACTIVE	DSBGA	YZR	5	3000	Green (RoHS & no Sb/Br)	SNAGCU	Level-1-260C-UNLIM	-30
LM3671TLX-ADJ/NOPB	ACTIVE	DSBGA	YZR	5	3000	Green (RoHS & no Sb/Br)	SNAGCU	Level-1-260C-UNLIM	-30

(1) The marketing status values are defined as follows:

ACTIVE: Product device recommended for new designs.

LIFEBUY: TI has announced that the device will be discontinued, and a lifetime-buy period is in effect.

NRND: Not recommended for new designs. Device is in production to support existing customers, but TI does not recommend using this part in a new design.

PREVIEW: Device has been announced but is not in production. Samples may or may not be available.

OBSELETE: TI has discontinued the production of the device.

(2) Eco Plan - The planned eco-friendly classification: Pb-Free (RoHS), Pb-Free (RoHS Exempt), or Green (RoHS & no Sb/Br) - please check <http://www.ti.com/produ> information and additional product content details.

TBD: The Pb-Free/Green conversion plan has not been defined.

Pb-Free (RoHS): TI's terms "Lead-Free" or "Pb-Free" mean semiconductor products that are compatible with the current RoHS requirements for all 6 substances lead not exceed 0.1% by weight in homogeneous materials. Where designed to be soldered at high temperatures, TI Pb-Free products are suitable for use in speci

Pb-Free (RoHS Exempt): This component has a RoHS exemption for either 1) lead-based flip-chip solder bumps used between the die and package, or 2) lead-ba the die and leadframe. The component is otherwise considered Pb-Free (RoHS compatible) as defined above.

Green (RoHS & no Sb/Br): TI defines "Green" to mean Pb-Free (RoHS compatible), and free of Bromine (Br) and Antimony (Sb) based flame retardants (Br or S in homogeneous material)

(3) MSL, Peak Temp. - The Moisture Sensitivity Level rating according to the JEDEC industry standard classifications, and peak solder temperature.

(4) There may be additional marking, which relates to the logo, the lot trace code information, or the environmental category on the device.



www.ti.com

PACKAGE

⁽⁵⁾ Multiple Device Markings will be inside parentheses. Only one Device Marking contained in parentheses and separated by a "~" will appear on a device. If a line is of the previous line and the two combined represent the entire Device Marking for that device.

⁽⁶⁾ Lead/Ball Finish - Orderable Devices may have multiple material finish options. Finish options are separated by a vertical ruled line. Lead/Ball Finish values may exceed the maximum column width.

Important Information and Disclaimer: The information provided on this page represents TI's knowledge and belief as of the date that it is provided. TI bases its knowledge on information provided by third parties, and makes no representation or warranty as to the accuracy of such information. Efforts are underway to better integrate information from third parties and TI continues to take reasonable steps to provide representative and accurate information but may not have conducted destructive testing or chemical analysis on individual devices. TI and TI suppliers consider certain information to be proprietary, and thus CAS numbers and other limited information may not be available for release.

In no event shall TI's liability arising out of such information exceed the total purchase price of the TI part(s) at issue in this document sold by TI to Customer on an as-shown basis.

OTHER QUALIFIED VERSIONS OF LM3671, LM3671-Q1 :

- Catalog: [LM3671](#)
- Automotive: [LM3671-Q1](#)

NOTE: Qualified Version Definitions:

- Catalog - TI's standard catalog product
- Automotive - Q100 devices qualified for high-reliability automotive applications targeting zero defects

TAPE AND REEL INFORMATION

QUADRANT ASSIGNMENTS FOR PIN 1 ORIENTATION IN TAPE

*All dimensions are nominal

Device	Package Type	Package Drawing	Pins	SPQ	Reel Diameter (mm)	Reel Width W1 (mm)	A0 (mm)	B0 (mm)	K0 (mm)	P1 (mm)	W (mm)	Pin1 Quadrant
LM3671LC-1.2/NOPB	USON	NKH	6	1000	178.0	12.4	2.2	2.2	1.0	8.0	12.0	Q1
LM3671LC-1.3/NOPB	USON	NKH	6	1000	178.0	12.4	2.2	2.2	1.0	8.0	12.0	Q1
LM3671LC-1.6/NOPB	USON	NKH	6	1000	178.0	12.4	2.2	2.2	1.0	8.0	12.0	Q1
LM3671LC-1.8/NOPB	USON	NKH	6	1000	178.0	12.4	2.2	2.2	1.0	8.0	12.0	Q1
LM3671MF-1.2	SOT-23	DBV	5	1000	178.0	8.4	3.2	3.2	1.4	4.0	8.0	Q3
LM3671MF-1.2/NOPB	SOT-23	DBV	5	1000	178.0	8.4	3.2	3.2	1.4	4.0	8.0	Q3
LM3671MF-1.25/NOPB	SOT-23	DBV	5	1000	178.0	8.4	3.2	3.2	1.4	4.0	8.0	Q3
LM3671MF-1.375/NOPB	SOT-23	DBV	5	1000	178.0	8.4	3.2	3.2	1.4	4.0	8.0	Q3
LM3671MF-1.5/NOPB	SOT-23	DBV	5	1000	178.0	8.4	3.2	3.2	1.4	4.0	8.0	Q3
LM3671MF-1.6/NOPB	SOT-23	DBV	5	1000	178.0	8.4	3.2	3.2	1.4	4.0	8.0	Q3
LM3671MF-1.8/NOPB	SOT-23	DBV	5	1000	178.0	8.4	3.2	3.2	1.4	4.0	8.0	Q3
LM3671MF-1.875/NOPB	SOT-23	DBV	5	1000	178.0	8.4	3.2	3.2	1.4	4.0	8.0	Q3
LM3671MF-2.5/NOPB	SOT-23	DBV	5	1000	178.0	8.4	3.2	3.2	1.4	4.0	8.0	Q3
LM3671MF-2.8	SOT-23	DBV	5	1000	178.0	8.4	3.2	3.2	1.4	4.0	8.0	Q3
LM3671MF-2.8/NOPB	SOT-23	DBV	5	1000	178.0	8.4	3.2	3.2	1.4	4.0	8.0	Q3
LM3671MF-3.3/NOPB	SOT-23	DBV	5	1000	178.0	8.4	3.2	3.2	1.4	4.0	8.0	Q3
LM3671MF-ADJ/NOPB	SOT-23	DBV	5	1000	178.0	8.4	3.2	3.2	1.4	4.0	8.0	Q3
LM3671MFX-1.2/NOPB	SOT-23	DBV	5	3000	178.0	8.4	3.2	3.2	1.4	4.0	8.0	Q3

Device	Package Type	Package Drawing	Pins	SPQ	Reel Diameter (mm)	Reel Width W1 (mm)	A0 (mm)	B0 (mm)	K0 (mm)	P1 (mm)	W (mm)	Pin1 Quadrant
LM3671MFX-1.25/NOPB	SOT-23	DBV	5	3000	178.0	8.4	3.2	3.2	1.4	4.0	8.0	Q3
LM3671MFX-1.8/NOPB	SOT-23	DBV	5	3000	178.0	8.4	3.2	3.2	1.4	4.0	8.0	Q3
LM3671MFX-1.875/NOPB	SOT-23	DBV	5	3000	178.0	8.4	3.2	3.2	1.4	4.0	8.0	Q3
LM3671MFX-2.5/NOPB	SOT-23	DBV	5	3000	178.0	8.4	3.2	3.2	1.4	4.0	8.0	Q3
LM3671MFX-2.8/NOPB	SOT-23	DBV	5	3000	178.0	8.4	3.2	3.2	1.4	4.0	8.0	Q3
LM3671MFX-3.3/NOPB	SOT-23	DBV	5	3000	178.0	8.4	3.2	3.2	1.4	4.0	8.0	Q3
LM3671MFX-ADJ/NOPB	SOT-23	DBV	5	3000	178.0	8.4	3.2	3.2	1.4	4.0	8.0	Q3
LM3671QMF-1.2/NOPB	SOT-23	DBV	5	1000	178.0	8.4	3.2	3.2	1.4	4.0	8.0	Q3
LM3671QMF-1.2/NOPB	SOT-23	DBV	5	3000	178.0	8.4	3.2	3.2	1.4	4.0	8.0	Q3
LM3671QTL-1.8/NOPB	DSBGA	YZR	5	250	178.0	8.4	1.14	1.47	0.76	4.0	8.0	Q1
LM3671QTLX-1.8/NOPB	DSBGA	YZR	5	3000	178.0	8.4	1.14	1.47	0.76	4.0	8.0	Q1
LM3671TL-1.2/NOPB	DSBGA	YZR	5	250	178.0	8.4	1.14	1.47	0.76	4.0	8.0	Q1
LM3671TL-1.5/NOPB	DSBGA	YZR	5	250	178.0	8.4	1.14	1.47	0.76	4.0	8.0	Q1
LM3671TL-1.8/NOPB	DSBGA	YZR	5	250	178.0	8.4	1.14	1.47	0.76	4.0	8.0	Q1
LM3671TL-2.5/NOPB	DSBGA	YZR	5	250	178.0	8.4	1.14	1.47	0.76	4.0	8.0	Q1
LM3671TL-2.8/NOPB	DSBGA	YZR	5	250	178.0	8.4	1.14	1.47	0.76	4.0	8.0	Q1
LM3671TL-3.3/NOPB	DSBGA	YZR	5	250	178.0	8.4	1.14	1.47	0.76	4.0	8.0	Q1
LM3671TL-ADJ/NOPB	DSBGA	YZR	5	250	178.0	8.4	1.14	1.47	0.76	4.0	8.0	Q1
LM3671TLX-1.2/NOPB	DSBGA	YZR	5	3000	178.0	8.4	1.14	1.47	0.76	4.0	8.0	Q1
LM3671TLX-1.5/NOPB	DSBGA	YZR	5	3000	178.0	8.4	1.14	1.47	0.76	4.0	8.0	Q1
LM3671TLX-1.8/NOPB	DSBGA	YZR	5	3000	178.0	8.4	1.14	1.47	0.76	4.0	8.0	Q1
LM3671TLX-1.875/NOPB	DSBGA	YZR	5	3000	178.0	8.4	1.14	1.47	0.76	4.0	8.0	Q1
LM3671TLX-2.5/NOPB	DSBGA	YZR	5	3000	178.0	8.4	1.14	1.47	0.76	4.0	8.0	Q1
LM3671TLX-2.8/NOPB	DSBGA	YZR	5	3000	178.0	8.4	1.14	1.47	0.76	4.0	8.0	Q1
LM3671TLX-3.3/NOPB	DSBGA	YZR	5	3000	178.0	8.4	1.14	1.47	0.76	4.0	8.0	Q1
LM3671TLX-ADJ/NOPB	DSBGA	YZR	5	3000	178.0	8.4	1.14	1.47	0.76	4.0	8.0	Q1

TAPE AND REEL BOX DIMENSIONS

*All dimensions are nominal

Device	Package Type	Package Drawing	Pins	SPQ	Length (mm)	Width (mm)	Height (mm)
LM3671LC-1.2/NOPB	USON	NKH	6	1000	210.0	185.0	35.0
LM3671LC-1.3/NOPB	USON	NKH	6	1000	210.0	185.0	35.0
LM3671LC-1.6/NOPB	USON	NKH	6	1000	210.0	185.0	35.0
LM3671LC-1.8/NOPB	USON	NKH	6	1000	210.0	185.0	35.0
LM3671MF-1.2	SOT-23	DBV	5	1000	210.0	185.0	35.0
LM3671MF-1.2/NOPB	SOT-23	DBV	5	1000	210.0	185.0	35.0
LM3671MF-1.25/NOPB	SOT-23	DBV	5	1000	210.0	185.0	35.0
LM3671MF-1.375/NOPB	SOT-23	DBV	5	1000	210.0	185.0	35.0
LM3671MF-1.5/NOPB	SOT-23	DBV	5	1000	210.0	185.0	35.0
LM3671MF-1.6/NOPB	SOT-23	DBV	5	1000	210.0	185.0	35.0
LM3671MF-1.8/NOPB	SOT-23	DBV	5	1000	210.0	185.0	35.0
LM3671MF-1.875/NOPB	SOT-23	DBV	5	1000	210.0	185.0	35.0
LM3671MF-2.5/NOPB	SOT-23	DBV	5	1000	210.0	185.0	35.0
LM3671MF-2.8	SOT-23	DBV	5	1000	210.0	185.0	35.0
LM3671MF-2.8/NOPB	SOT-23	DBV	5	1000	210.0	185.0	35.0
LM3671MF-3.3/NOPB	SOT-23	DBV	5	1000	210.0	185.0	35.0
LM3671MF-ADJ/NOPB	SOT-23	DBV	5	1000	210.0	185.0	35.0
LM3671MFX-1.2/NOPB	SOT-23	DBV	5	3000	210.0	185.0	35.0
LM3671MFX-1.25/NOPB	SOT-23	DBV	5	3000	210.0	185.0	35.0
LM3671MFX-1.8/NOPB	SOT-23	DBV	5	3000	210.0	185.0	35.0

Device	Package Type	Package Drawing	Pins	SPQ	Length (mm)	Width (mm)	Height (mm)
LM3671MFX-1.875/NOPB	SOT-23	DBV	5	3000	210.0	185.0	35.0
LM3671MFX-2.5/NOPB	SOT-23	DBV	5	3000	210.0	185.0	35.0
LM3671MFX-2.8/NOPB	SOT-23	DBV	5	3000	210.0	185.0	35.0
LM3671MFX-3.3/NOPB	SOT-23	DBV	5	3000	210.0	185.0	35.0
LM3671MFX-ADJ/NOPB	SOT-23	DBV	5	3000	210.0	185.0	35.0
LM3671QMF-1.2/NOPB	SOT-23	DBV	5	1000	210.0	185.0	35.0
LM3671QMFX-1.2/NOPB	SOT-23	DBV	5	3000	210.0	185.0	35.0
LM3671QTL-1.8/NOPB	DSBGA	YZR	5	250	210.0	185.0	35.0
LM3671QTLX-1.8/NOPB	DSBGA	YZR	5	3000	210.0	185.0	35.0
LM3671TL-1.2/NOPB	DSBGA	YZR	5	250	210.0	185.0	35.0
LM3671TL-1.5/NOPB	DSBGA	YZR	5	250	210.0	185.0	35.0
LM3671TL-1.8/NOPB	DSBGA	YZR	5	250	210.0	185.0	35.0
LM3671TL-2.5/NOPB	DSBGA	YZR	5	250	210.0	185.0	35.0
LM3671TL-2.8/NOPB	DSBGA	YZR	5	250	210.0	185.0	35.0
LM3671TL-3.3/NOPB	DSBGA	YZR	5	250	210.0	185.0	35.0
LM3671TL-ADJ/NOPB	DSBGA	YZR	5	250	210.0	185.0	35.0
LM3671TLX-1.2/NOPB	DSBGA	YZR	5	3000	210.0	185.0	35.0
LM3671TLX-1.5/NOPB	DSBGA	YZR	5	3000	210.0	185.0	35.0
LM3671TLX-1.8/NOPB	DSBGA	YZR	5	3000	210.0	185.0	35.0
LM3671TLX-1.875/NOPB	DSBGA	YZR	5	3000	210.0	185.0	35.0
LM3671TLX-2.5/NOPB	DSBGA	YZR	5	3000	210.0	185.0	35.0
LM3671TLX-2.8/NOPB	DSBGA	YZR	5	3000	210.0	185.0	35.0
LM3671TLX-3.3/NOPB	DSBGA	YZR	5	3000	210.0	185.0	35.0
LM3671TLX-ADJ/NOPB	DSBGA	YZR	5	3000	210.0	185.0	35.0

DBV (R-PDSO-G5)

PLASTIC SMALL-OUTLINE PACKAGE



- NOTES:
- A. All linear dimensions are in millimeters.
 - B. This drawing is subject to change without notice.
 - C. Body dimensions do not include mold flash or protrusion. Mold flash and protrusion shall not exceed 0.15 per side.
 - D. Falls within JEDEC MO-178 Variation AA.

DBV (R-PDSO-G5)

PLASTIC SMALL OUTLINE



- NOTES:
- A. All linear dimensions are in millimeters.
 - B. This drawing is subject to change without notice.
 - C. Customers should place a note on the circuit board fabrication drawing not to alter the center solder mask defined pad.
 - D. Publication IPC-7351 is recommended for alternate designs.
 - E. Laser cutting apertures with trapezoidal walls and also rounding corners will offer better paste release. Customers should contact their board assembly site for stencil design recommendations. Example stencil design based on a 50% volumetric metal load solder paste. Refer to IPC-7525 for other stencil recommendations.

NKH0006B

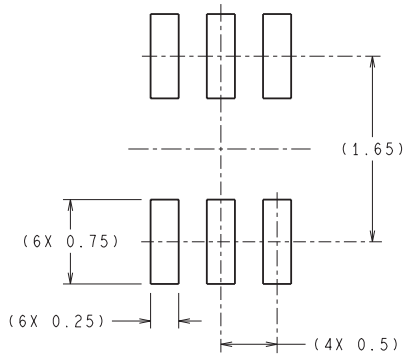

RECOMMENDED LAND PATTERN

DIMENSIONS ARE IN MILLIMETERS
DIMENSION IN () FOR REFERENCE ONLY

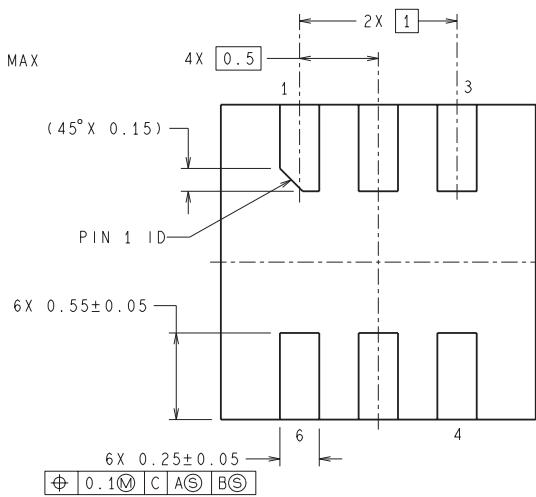
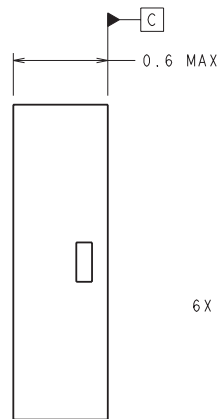
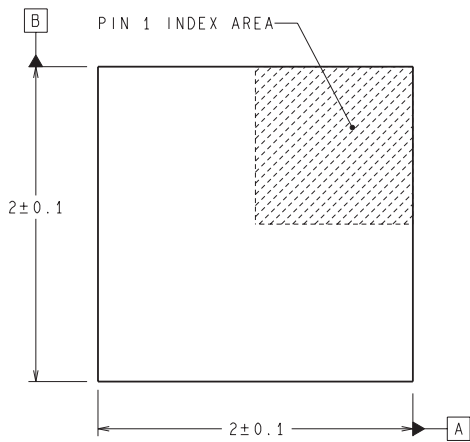
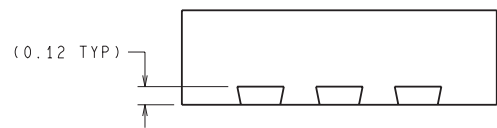

Φ 0.1 (M) C A ⊙ B ⊙

LCA06B (Rev A)

YZR0005

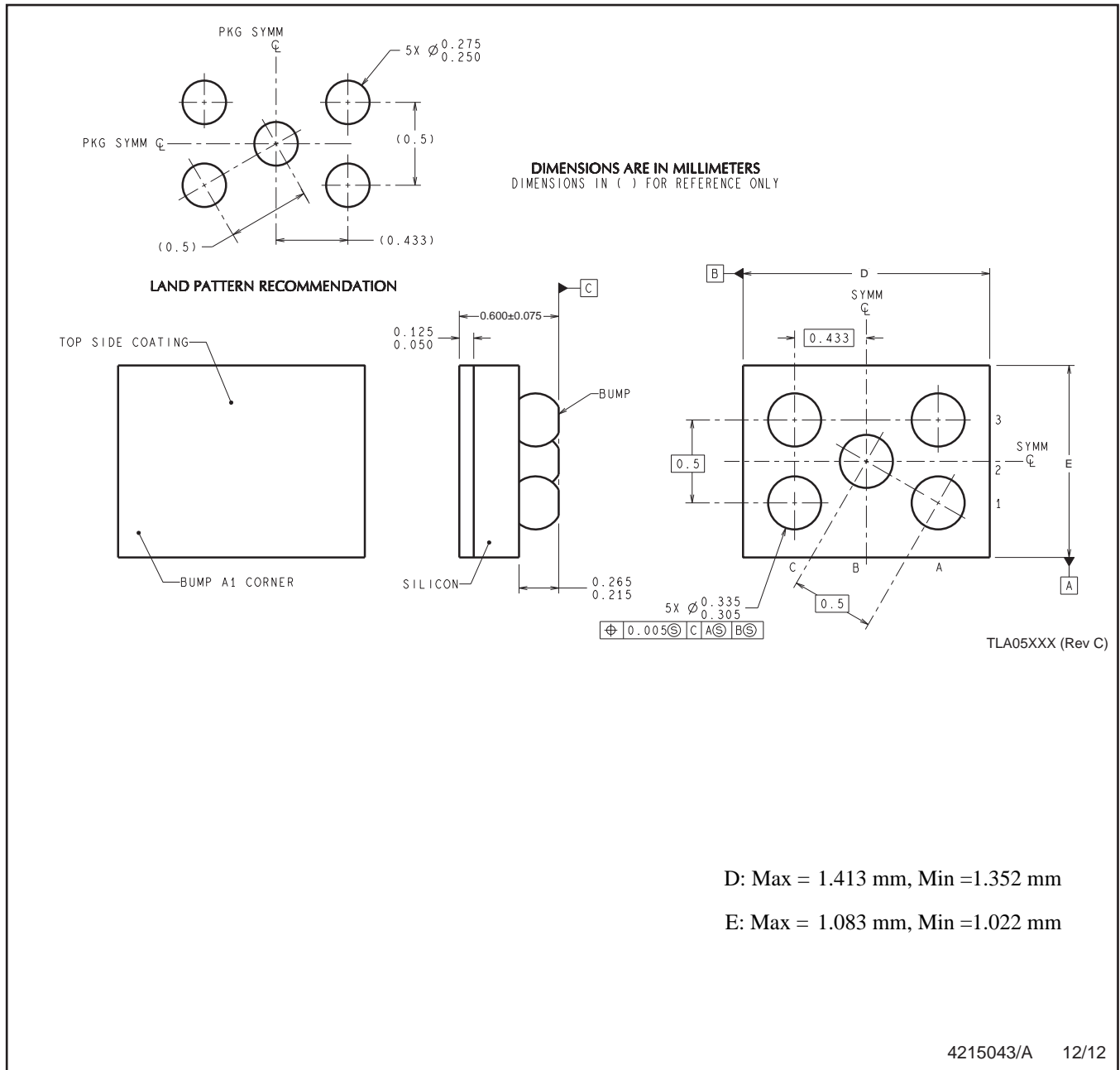

NOTES: A. All linear dimensions are in millimeters. Dimensioning and tolerancing per ASME Y14.5M-1994.
 B. This drawing is subject to change without notice.

IMPORTANT NOTICE

Texas Instruments Incorporated and its subsidiaries (TI) reserve the right to make corrections, enhancements, improvements and other changes to its semiconductor products and services per JESD46, latest issue, and to discontinue any product or service per JESD48, latest issue. Buyers should obtain the latest relevant information before placing orders and should verify that such information is current and complete. All semiconductor products (also referred to herein as "components") are sold subject to TI's terms and conditions of sale supplied at the time of order acknowledgment.

TI warrants performance of its components to the specifications applicable at the time of sale, in accordance with the warranty in TI's terms and conditions of sale of semiconductor products. Testing and other quality control techniques are used to the extent TI deems necessary to support this warranty. Except where mandated by applicable law, testing of all parameters of each component is not necessarily performed.

TI assumes no liability for applications assistance or the design of Buyers' products. Buyers are responsible for their products and applications using TI components. To minimize the risks associated with Buyers' products and applications, Buyers should provide adequate design and operating safeguards.

TI does not warrant or represent that any license, either express or implied, is granted under any patent right, copyright, mask work right, or other intellectual property right relating to any combination, machine, or process in which TI components or services are used. Information published by TI regarding third-party products or services does not constitute a license to use such products or services or a warranty or endorsement thereof. Use of such information may require a license from a third party under the patents or other intellectual property of the third party, or a license from TI under the patents or other intellectual property of TI.

Reproduction of significant portions of TI information in TI data books or data sheets is permissible only if reproduction is without alteration and is accompanied by all associated warranties, conditions, limitations, and notices. TI is not responsible or liable for such altered documentation. Information of third parties may be subject to additional restrictions.

Resale of TI components or services with statements different from or beyond the parameters stated by TI for that component or service voids all express and any implied warranties for the associated TI component or service and is an unfair and deceptive business practice. TI is not responsible or liable for any such statements.

Buyer acknowledges and agrees that it is solely responsible for compliance with all legal, regulatory and safety-related requirements concerning its products, and any use of TI components in its applications, notwithstanding any applications-related information or support that may be provided by TI. Buyer represents and agrees that it has all the necessary expertise to create and implement safeguards which anticipate dangerous consequences of failures, monitor failures and their consequences, lessen the likelihood of failures that might cause harm and take appropriate remedial actions. Buyer will fully indemnify TI and its representatives against any damages arising out of the use of any TI components in safety-critical applications.

In some cases, TI components may be promoted specifically to facilitate safety-related applications. With such components, TI's goal is to help enable customers to design and create their own end-product solutions that meet applicable functional safety standards and requirements. Nonetheless, such components are subject to these terms.

No TI components are authorized for use in FDA Class III (or similar life-critical medical equipment) unless authorized officers of the parties have executed a special agreement specifically governing such use.

Only those TI components which TI has specifically designated as military grade or "enhanced plastic" are designed and intended for use in military/aerospace applications or environments. Buyer acknowledges and agrees that any military or aerospace use of TI components which have **not** been so designated is solely at the Buyer's risk, and that Buyer is solely responsible for compliance with all legal and regulatory requirements in connection with such use.

TI has specifically designated certain components as meeting ISO/TS16949 requirements, mainly for automotive use. In any case of use of non-designated products, TI will not be responsible for any failure to meet ISO/TS16949.

Products

Audio	www.ti.com/audio
Amplifiers	amplifier.ti.com
Data Converters	dataconverter.ti.com
DLP® Products	www.dlp.com
DSP	dsp.ti.com
Clocks and Timers	www.ti.com/clocks
Interface	interface.ti.com
Logic	logic.ti.com
Power Mgmt	power.ti.com
Microcontrollers	microcontroller.ti.com
RFID	www.ti-rfid.com
OMAP Applications Processors	www.ti.com/omap
Wireless Connectivity	www.ti.com/wirelessconnectivity

Applications

Automotive and Transportation	www.ti.com/automotive
Communications and Telecom	www.ti.com/communications
Computers and Peripherals	www.ti.com/computers
Consumer Electronics	www.ti.com/consumer-apps
Energy and Lighting	www.ti.com/energy
Industrial	www.ti.com/industrial
Medical	www.ti.com/medical
Security	www.ti.com/security
Space, Avionics and Defense	www.ti.com/space-avionics-defense
Video and Imaging	www.ti.com/video

TI E2E Community

e2e.ti.com

X-ON Electronics

Largest Supplier of Electrical and Electronic Components

Click to view similar products for [Power Management IC Development Tools](#) category:

Click to view products by [Adafruit](#) manufacturer:

Other Similar products are found below :

[EVAL-ADM1168LQEBZ](#) [EVB-EP5348UI](#) [MIC23451-AAAYFL EV](#) [MIC5281YMME EV](#) [DA9063-EVAL](#) [ADP122-3.3-EVALZ](#) [ADP130-0.8-EVALZ](#) [ADP130-1.2-EVALZ](#) [ADP130-1.5-EVALZ](#) [ADP130-1.8-EVALZ](#) [ADP1714-3.3-EVALZ](#) [ADP1716-2.5-EVALZ](#) [ADP1740-1.5-EVALZ](#) [ADP1752-1.5-EVALZ](#) [ADP1828LC-EVALZ](#) [ADP1870-0.3-EVALZ](#) [ADP1871-0.6-EVALZ](#) [ADP1873-0.6-EVALZ](#) [ADP1874-0.3-EVALZ](#) [ADP1882-1.0-EVALZ](#) [ADP199CB-EVALZ](#) [ADP2102-1.25-EVALZ](#) [ADP2102-1.875EVALZ](#) [ADP2102-1.8-EVALZ](#) [ADP2102-2-EVALZ](#) [ADP2102-3-EVALZ](#) [ADP2102-4-EVALZ](#) [ADP2106-1.8-EVALZ](#) [ADP2147CB-110EVALZ](#) [AS3606-DB](#) [BQ24010EVM](#) [BQ24075TEVM](#) [BQ24155EVM](#) [BQ24157EVM-697](#) [BQ24160EVM-742](#) [BQ24296MEVM-655](#) [BQ25010EVM](#) [BQ3055EVM](#) [NCV891330PD50GEVB](#) [ISLUSBI2CKIT1Z](#) [LM2744EVAL](#) [LM2854EVAL](#) [LM3658SD-AEV/NOPB](#) [LM3658SDEV/NOPB](#) [LM3691TL-1.8EV/NOPB](#) [LM4510SDEV/NOPB](#) [LM5033SD-EVAL](#) [LP38512TS-1.8EV](#) [EVAL-ADM1186-1MBZ](#) [EVAL-ADM1186-2MBZ](#)