

IS31FL3731

AUDIO MODULATED MATRIX LED DRIVER

May 2013

GENERAL DESCRIPTION

The IS31FL3731 is a compact LED driver for 144 single LEDs. The device can be programmed via an I2C compatible interface. The IS31FL3731 offers two blocks each driving 72 LEDs with 1/9 cycle rate. The required lines to drive all 144 LEDs are reduced to 18 by using the cross-plexing feature optimizing space on the PCB. Additionally each of the 144 LEDs can be dimmed individually with 8-bit allowing 256 steps of linear dimming.

To reduce CPU usage up to 8 frames can be stored with individual time delays between frames to play small animations automatically. LED frames can be modulated with audio signal.

IS31FL3731 is available in QFN-28 (4mm × 4mm) and SSOP-28 package. It operates from 2.7V to 5.5V over the temperature range of -40°C to +85°C.

FEATURES

- Supply voltage range: 2.7V to 5.5V
- 400kHz I2C-compatible interface
- 144 LEDs in dot matrix
- Individual blink control
- 8 frames memory for animations
- Picture mode and animation mode
- Auto intensity breathing during the switching of different frames
- LED frames displayed can be modulated with audio signal intensity
- LED light intensity can be modulated with audio signal intensity
- QFN-28 (4mm × 4mm) and SSOP-28 package

APPLICATIONS

- Mobile phones and other hand-held devices for LED display
- LED in home appliances

TYPICAL APPLICATION CIRCUIT

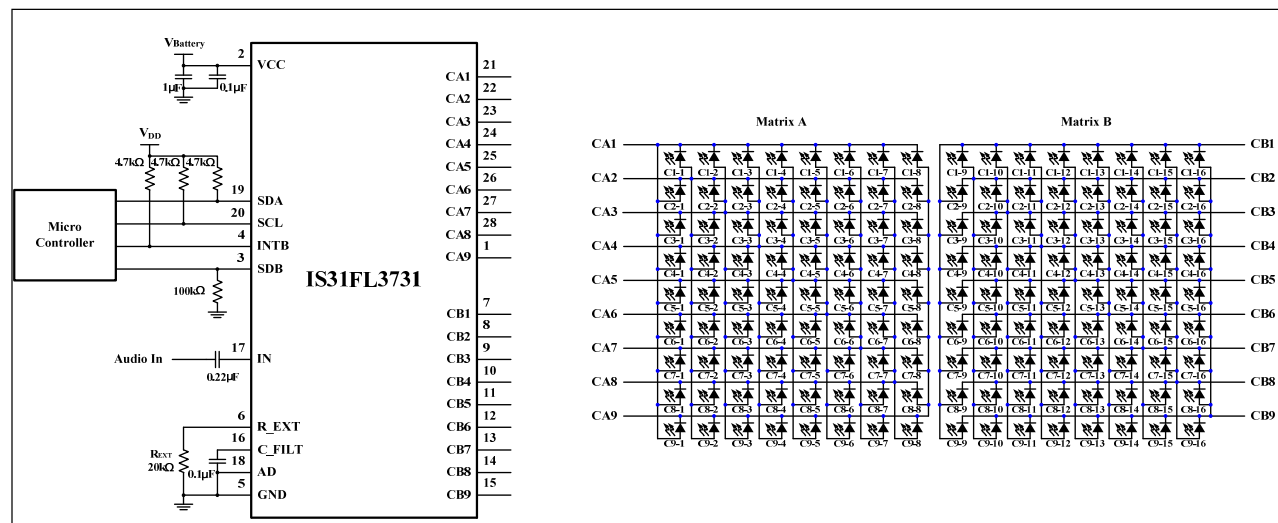

Figure 1 Typical Application Circuit

Note 1: The IC should be placed far away from the mobile antenna in order to prevent the EMI.

Note 2: The average current of each LED is 3.2mA when $R_{EXT} = 20k\Omega$. The LED current can be modulated by the R_{EXT} . Please refer to the detail information in Page 18.

IS31FL3731

PIN CONFIGURATION

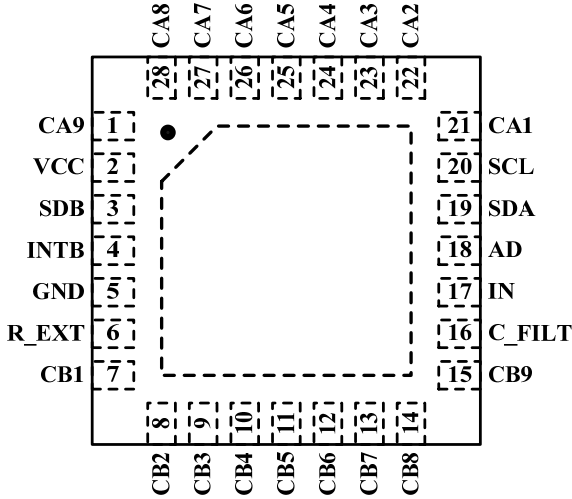
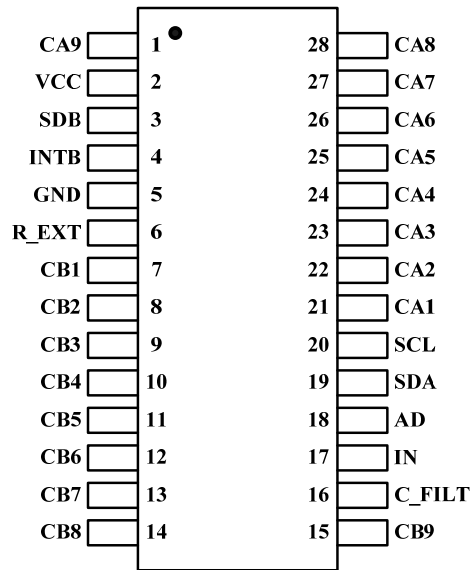
Package	Pin Configuration (Top View)
QFN-28	
SSOP-28	

IS31FL3731

PIN DESCRIPTION

No.	Pin	Description
1	CA9	LED matrix A current output/input port.
2	VCC	Power supply.
3	SDB	Shutdown the chip when pull to low.
4	INTB	Interrupt output. Active low.
5	GND	Ground.
6	R_EXT	20kΩ resistance to confirm the LED current.
7 ~ 15	CB1 ~ CB9	LED matrix B current output/input port.
16	C_FILT	Capacitor used for audio.
17	IN	Audio input.
18	AD	I2C address setting.
19	SDA	I2C compatible serial data.
20	SCL	I2C compatible serial clock.
21 ~ 28	CA1 ~ CA8	LED matrix A current output/input port.
	Thermal Pad	Connect to GND.

Copyright © 2013 Integrated Silicon Solution, Inc. All rights reserved. ISSI reserves the right to make changes to this specification and its products at any time without notice. ISSI assumes no liability arising out of the application or use of any information, products or services described herein. Customers are advised to obtain the latest version of this device specification before relying on any published information and before placing orders for products. Integrated Silicon Solution, Inc. does not recommend the use of any of its products in life support applications where the failure or malfunction of the product can reasonably be expected to cause failure of the life support system or to significantly affect its safety or effectiveness. Products are not authorized for use in such applications unless Integrated Silicon Solution, Inc. receives written assurance to its satisfaction, that:

- a.) the risk of injury or damage has been minimized;
- b.) the user assume all such risks; and
- c.) potential liability of Integrated Silicon Solution, Inc is adequately protected under the circumstances



IS31FL3731

ORDERING INFORMATION

INDUSTRIAL RANGE: -40°C TO +85°C

Order Part No.	Package	QTY/Reel
IS31FL3731-QFLS2-TR	QFN-28, Lead-free	2500/Reel
IS31FL3731-SALS2	SSOP-28, Lead-free	48/Tube



IS31FL3731

ABSOLUTE MAXIMUM RATINGS

Supply voltage, V_{CC}	-0.3V ~ +5.5V
Voltage at any input pin	-0.3V ~ $V_{CC}+0.3V$
Maximum junction temperature, T_{JMAX}	150°C
Storage temperature range, T_{STG}	-65°C ~ +150°C
Operating temperature range, T_A	-40°C ~ +85°C

Note:

Stresses beyond those listed under “Absolute Maximum Ratings” may cause permanent damage to the device. These are stress ratings only and functional operation of the device at these or any other condition beyond those indicated in the operational sections of the specifications is not implied. Exposure to absolute maximum rating conditions for extended periods may affect device reliability.

ELECTRICAL CHARACTERISTICS

$T_A = -40^{\circ}C \sim +85^{\circ}C$, $V_{CC} = 2.7V \sim 5.5V$, unless otherwise noted. Typical value is $T_A = 25^{\circ}C$, $V_{CC} = 3.6V$.

Symbol	Parameter	Conditions	Min.	Typ.	Max.	Unit
V_{CC}	Supply voltage		2.7		5.5	V
I_{CC}	Quiescent power supply current	$V_{IN} = 0V$, without audio input, all LEDs off		2.17		mA
I_{SD}	Shutdown current	$V_{SDB} = 0V$		0.5	5	μA
		$V_{SDB} = V_{CC}$, software shutdown		230		
I_{OUT}	Output current of C1~C9	Matrix display mode without audio modulation		34 (Note 1)		mA
V_{HR}	Current sink headroom voltage C1~C9	$I_{sink} = 270mA$ (Note 2)		400		mV
	Current source headroom voltage C1~C9	$I_{source} = 34mA$		400		
t_{SCAN}	Period of scanning (Figure 2)			106		μs
t_{SCANOL}	Non-overlap blanking time during scan (Figure 2)			15		μs
I_{LED}	Average current of each LED	$R_{EXT} = 20k\Omega$, PWM in 255 step (Note 3)		3.2		mA

Logic Electrical Characteristics (SDA, SCL, AD)

V_{IL}	Logic “0” input voltage	$V_{CC} = 2.7V$			0.4	V
V_{IH}	Logic “1” input voltage	$V_{CC} = 5.5V$	1.4			V
I_{IL}	Logic “0” input current	$V_{INPUT} = 0V$		5 (Note 4)		nA
I_{IH}	Logic “1” input current	$V_{INPUT} = V_{CC}$		5 (Note 4)		nA

IS31FL3731

DIGITAL INPUT SWITCHING CHARACTERISTICS (Note 4)

Symbol	Parameter	Condition	Min.	Typ.	Max.	Units
f_{SCL}	Serial-Clock frequency				400	kHz
t_{BUF}	Bus free time between a STOP and a START condition		1.3			μs
$t_{HD, STA}$	Hold time (repeated) START condition		0.6			μs
$t_{SU, STA}$	Repeated START condition setup time		0.6			μs
$t_{SU, STO}$	STOP condition setup time		0.6			μs
$t_{HD, DAT}$	Data hold time				0.9	μs
$t_{SU, DAT}$	Data setup time		100			ns
t_{LOW}	SCL clock low period		1.3			μs
t_{HIGH}	SCL clock high period		0.7			μs
t_R	Rise time of both SDA and SCL signals, receiving	(Note 5)		$20+0.1C_b$	300	ns
t_F	Fall time of both SDA and SCL signals, receiving	(Note 5)		$20+0.1C_b$	300	ns

Note 1: The average current of each LED is $I_{OUT}/10.5$.

Note 2: All LEDs are on.

Note 3: $I_{LED} = 64.7/R_{EXT}$, $R_{EXT} = 20k\Omega$ is recommended. The recommended minimum value of R_{EXT} is $18k\Omega$, or it may cause a large current.

Note 4: Guaranteed by design.

Note 5: C_b = total capacitance of one bus line in pF. $I_{SINK} \leq 6mA$. t_R and t_F measured between $0.3 \times V_{CC}$ and $0.7 \times V_{CC}$.

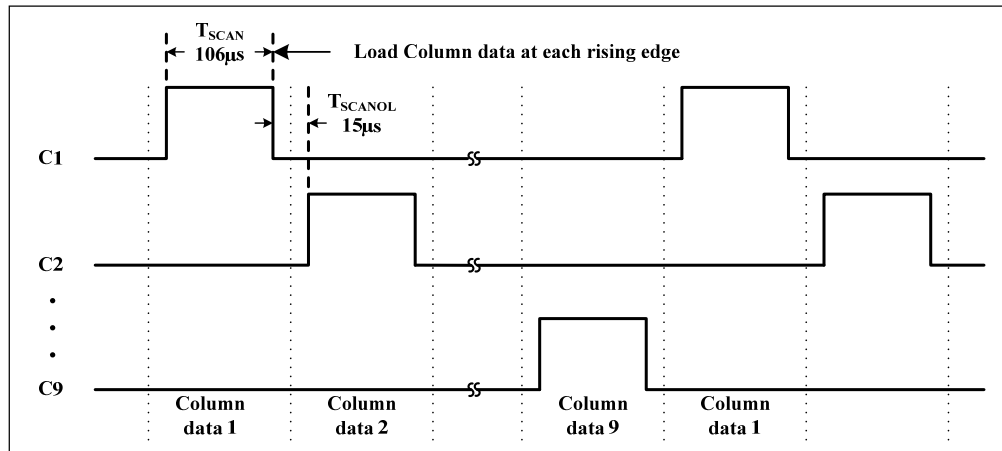

Figure 2 Scanning timing

IS31FL3731

DETAILED DESCRIPTION

I2C INTERFACE

The IS31FL3731 uses a serial bus, which conforms to the I2C protocol, to control the chip's functions with two wires: SCL and SDA. The IS31FL3731 has a 7-bit slave address (A7:A1), followed by the R/W bit, A0. Set A0 to "0" for a write command and set A0 to "1" for a read command. The value of bits A1 and A2 are decided by the connection of the AD pin.

The complete slave address is:

Table 1 Slave Address (Write only):

Bit	A7:A3	A2:A1	A0
Value	11101	AD	0/1

AD connected to GND, AD=00;
 AD connected to VCC, AD=11;
 AD connected to SCL, AD=01;
 AD connected to SDA, AD=10;

The SCL line is uni-directional. The SDA line is bi-directional (open-collector) with a pull-up resistor (typically 4.7kΩ). The maximum clock frequency specified by the I2C standard is 400kHz. In this discussion, the master is the microcontroller and the slave is the IS31FL3731.

The timing diagram for the I2C is shown in Figure 3. The SDA is latched in on the stable high level of the SCL. When there is no interface activity, the SDA line should be held high.

The "START" signal is generated by lowering the SDA signal while the SCL signal is high. The start signal will alert all devices attached to the I2C bus to check the incoming address against their own chip address.

The 8-bit chip address is sent next, most significant bit first. Each address bit must be stable while the SCL level is high.

After the last bit of the chip address is sent, the master checks for the IS31FL3731's acknowledge. The master releases the SDA line high (through a pull-up resistor). Then the master sends an SCL pulse. If the IS31FL3731 has received the address correctly, then it holds the SDA line low during the SCL pulse. If the SDA line is not low, then the master should send a "STOP" signal (discussed later) and abort the transfer.

Following acknowledge of IS31FL3731, the register address byte is sent, most significant bit first. IS31FL3731 must generate another acknowledge indicating that the register address has been received.

Then 8-bit of data byte are sent next, most significant bit first. Each data bit should be valid while the SCL level is stable high. After the data byte is sent, the IS31FL3731 must generate another acknowledge to indicate that the data was received.

The "STOP" signal ends the transfer. To signal "STOP", the SDA signal goes high while the SCL signal is high.

ADDRESS AUTO INCREMENT

To write multiple bytes of data into IS31FL3731, load the address of the data register that the first data byte is intended for. During the IS31FL3731 acknowledge of receiving the data byte, the internal address pointer will increment by one. The next data byte sent to IS31FL3731 will be placed in the new address, and so on. The auto increment of the address will continue as long as data continues to be written to IS31FL3731 (Figure 6).

READING PORT REGISTERS

All of registers in IS31FL3731 can be read. But Frame Registers can only be read in software shutdown mode as SDB pin is high. The Function Register can be read in software shutdown mode or operating mode.

To read the device data, the bus master must first send the IS31FL3731 address with the R/W bit set to "0", followed by the Command Register address, FDh, then send command data which determines which response register is accessed. After a restart, the bus master must send the IS31FL3731 address with the R/W bit set to "0" again, followed by the register address which determines which register is accessed. Then restart I2C, the bus master should send the IS31FL3731 address with the R/W bit set to "1". Data from the register defined by the command byte is then sent from the IS31FL3731 to the master (Figure 7).

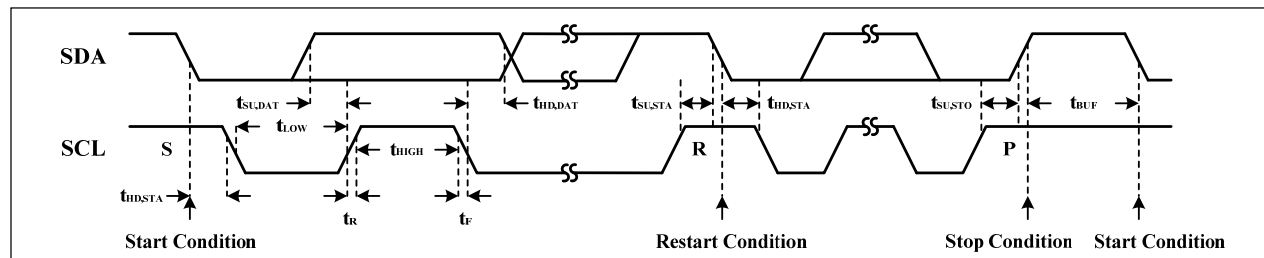
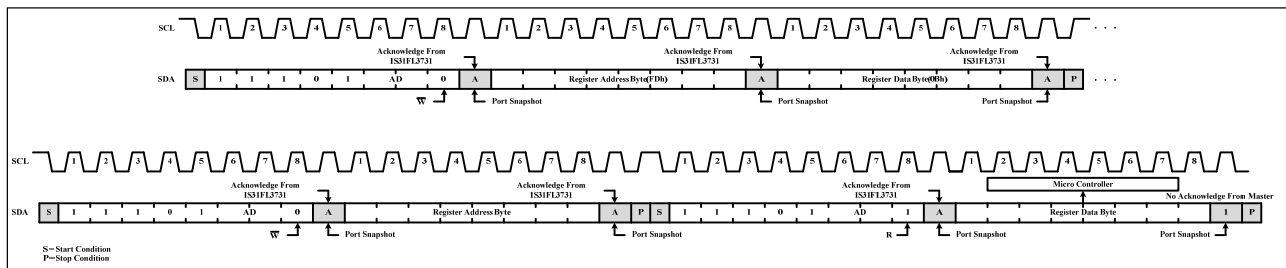
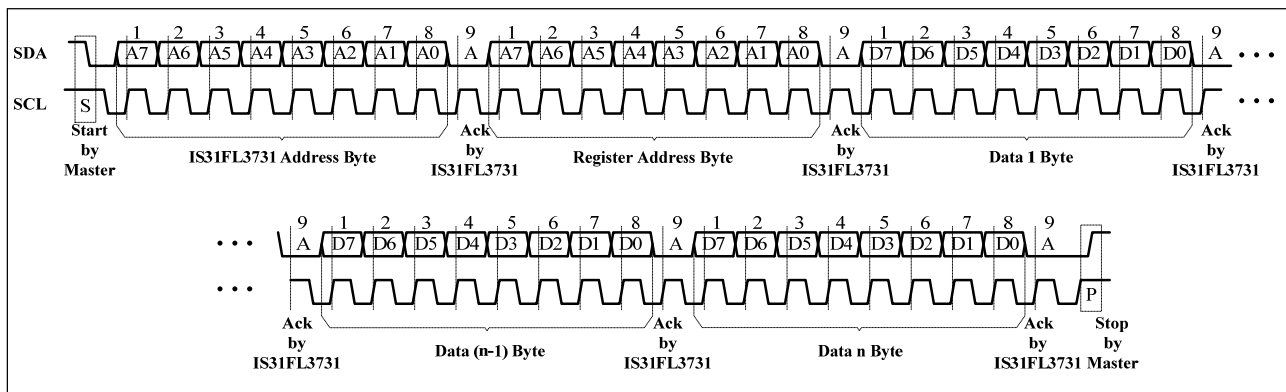
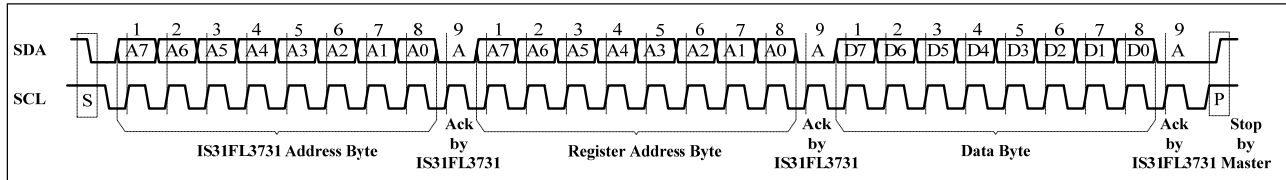
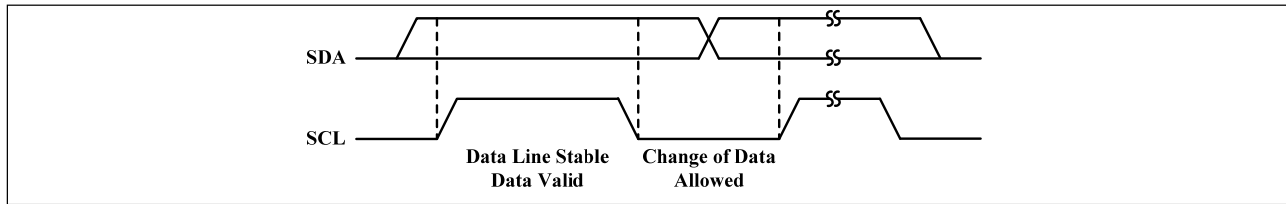

Figure 3 Interface timing

IS31FL3731



IS31FL3731

REGISTER DEFINITION

Table 2 FDh Command Register

Data	Function	Data	Function
0000 0000	Point to Page One(Frame 1 Register is available)	0000 0001	Point to Page Two(Frame 2 Register is available)
0000 0010	Point to Page Three(Frame 3 Register is available)	0000 0011	Point to Page Four(Frame 4 Register is available)
0000 0100	Point to Page Five(Frame 5 Register is available)	0000 0101	Point to Page Six(Frame 6 Register is available)
0000 0110	Point to Page Seven(Frame 7 Register is available)	0000 0111	Point to Page Eight(Frame 8 Register is available)
0000 1011	Point to Page Nine(Function Register is available)	Others	Reserved

Note: The Command Register should be configured first after writing in the slave address to choose the available register (Frame Registers and Function Registers). Then write data in the choosing register.
For example, when write "0000 0011" in the Command Register (FDh), the data which writing after will be stored in the Frame 4 Register. Write new data can configure other registers.

Table 3 Response Register Function

(The address of each Page is starting from 00h. Frame Registers have the same format.)

Address	Name	Function	Table	R/W	Default
Frame Register (Page One to Page Eight) (Note 6)					
00h ~ 11h	LED Control Register	Store on or off state for each LED	4	R/W	xxxx xxxx
12h ~ 23h	Blink Control Register	Control the blink function for each LED	5	R/W	
24h ~ B3h	PWM Register	144 LEDs PWM duty cycle data register	6	R/W	
Function Register (Page Night)					
00h	Configuration Register	Configure the operation mode	8	R/W	0000 0000
01h	Picture Display Register	Set the display frame in Picture Mode	9	R/W	
02h	Auto Play Control Register 1	Set the way of display in Auto Frame Play Mode	10	R/W	
03h	Auto Play Control Register 2	Set the delay time in Auto Frame Play Mode	11	R/W	
04h	Reserved (Note 7)	Reserved	-	R/W	
05h	Display Option Register	Set the display option	12	R/W	
06h	Audio Synchronization Register	Set audio synchronization function	13	R/W	
07h	Frame State Register	Store the frame display information	14	R	
08h	Breath Control Register 1	Set fade in and fade out time for breath function	15	R/W	
09h	Breath Control Register 2	Set the breath function	16	R/W	
0Ah	Shutdown Register	Set software shutdown mode	17	R/W	
0Bh	AGC Control Register	Set the AGC function and the audio gain.	18	R/W	
0Ch	Audio ADC Rate Register	Set the ADC sample rate of the input signal	19	R/W	

Note 6: The data of Frame Registers is not assured when power on. Please initialize the Frame Registers first to ensure operate normally.

Note 7: The 04h register has no function although it can be written. It also can be read but the data is not assured.

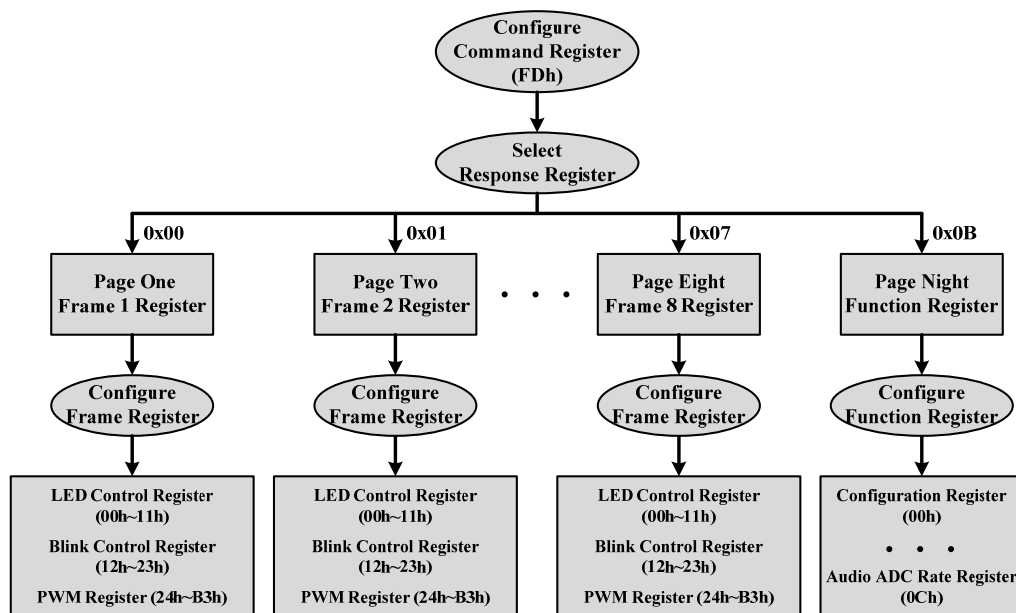

FRAME REGISTER

Table 4 00h ~ 11h LED Control Register

Bit	D7:D0
Name	C _{X-8} : C _{X-1} or C _{X-16} : C _{X-9}
Default	xxxx xxxx

The LED Control Registers store the on or off state of each LED in the Matrix A and B. Please refer to the detail information in Table 7.

C _{X-Y}	LED State Bit
0	LED off
1	LED on

Figure 8 in Page 11 shows the ordering of C_{X-Y}.

Table 5 12h ~ 23h Blink Control Register

Bit	D7:D0
Name	C _{X-8} : C _{X-1} or C _{X-16} : C _{X-9}
Default	xxxx xxxx

The Blink Control Registers configure the blink function of each LED in the Matrix A and B. Please refer to the detail information in Table 7.

C _{X-Y}	Blink Control Bit
0	Disable
1	Enable

Figure 8 in Page 11 shows the ordering of C_{X-Y}.

Table 6 24h ~ B3h PWM Register

Bit	D7:D0
Name	PWM
Default	xxxx xxxx

PWM Registers modulate the 144 LEDs in 256 steps. The value of the PWM Registers decides the output current of each LED. The output current may be computed using the Formula (1):

$$I_{PWM} = \frac{I_{LED}}{256} \cdot \sum_{n=0}^7 D[n] \cdot 2^n \quad (1)$$

Where D[n] stands for the individual bit value, 1 or 0, in location n.

For example: if D7:D0 = 10110101,

$$I_{PWM} = I_{LED} (2^0 + 2^2 + 2^4 + 2^5 + 2^7) / 256$$

I_{LED} is set by the external resistor, R_{EXT}, I_{LED} = 64.7/R_{EXT}.

For example, when R_{EXT} = 20kΩ, I_{LED} = 64.7/20 = 3.2mA.

IS31FL3731

Table 7 Address of Frame Register

LED Location		LED Control Register		Blink Control Register		PWM Register	
Matrix A	Matrix B	Matrix A	Matrix B	Matrix A	Matrix B	Matrix A	Matrix B
CA1(C₁₋₁~C₁₋₈)	CB1(C ₁₋₉ ~C ₁₋₁₆)	00h	01h	12h	13h	24h ~ 2Bh	2Ch ~ 33h
CA2(C₂₋₁~C₂₋₈)	CB2(C ₂₋₉ ~C ₂₋₁₆)	02h	03h	14h	15h	34h ~ 3Bh	3Ch ~ 43h
CA3(C₃₋₁~C₃₋₈)	CB3(C ₃₋₉ ~C ₃₋₁₆)	04h	05h	16h	17h	44h ~ 4Bh	4Ch ~ 53h
CA4(C₄₋₁~C₄₋₈)	CB4(C ₄₋₉ ~C ₄₋₁₆)	06h	07h	18h	19h	54h ~ 5Bh	5Ch ~ 63h
CA5(C₅₋₁~C₅₋₈)	CB5(C ₅₋₉ ~C ₅₋₁₆)	08h	09h	1Ah	1Bh	64h ~ 6Bh	6Ch ~ 73h
CA6(C₆₋₁~C₆₋₈)	CB6(C ₆₋₉ ~C ₆₋₁₆)	0Ah	0Bh	1Ch	1Dh	74h ~ 7Bh	7Ch ~ 83h
CA7(C₇₋₁~C₇₋₈)	CB7(C ₇₋₉ ~C ₇₋₁₆)	0Ch	0Dh	1Eh	1Fh	84h ~ 8Bh	8Ch ~ 93h
CA8(C₈₋₁~C₈₋₈)	CB8(C ₈₋₉ ~C ₈₋₁₆)	0Eh	0Fh	20h	21h	94h ~ 9Bh	9Ch ~ A3h
CA9(C₉₋₁~C₉₋₈)	CB9(C ₉₋₉ ~C ₉₋₁₆)	10h	11h	22h	23h	A4h ~ ABh	ACh ~ B3h

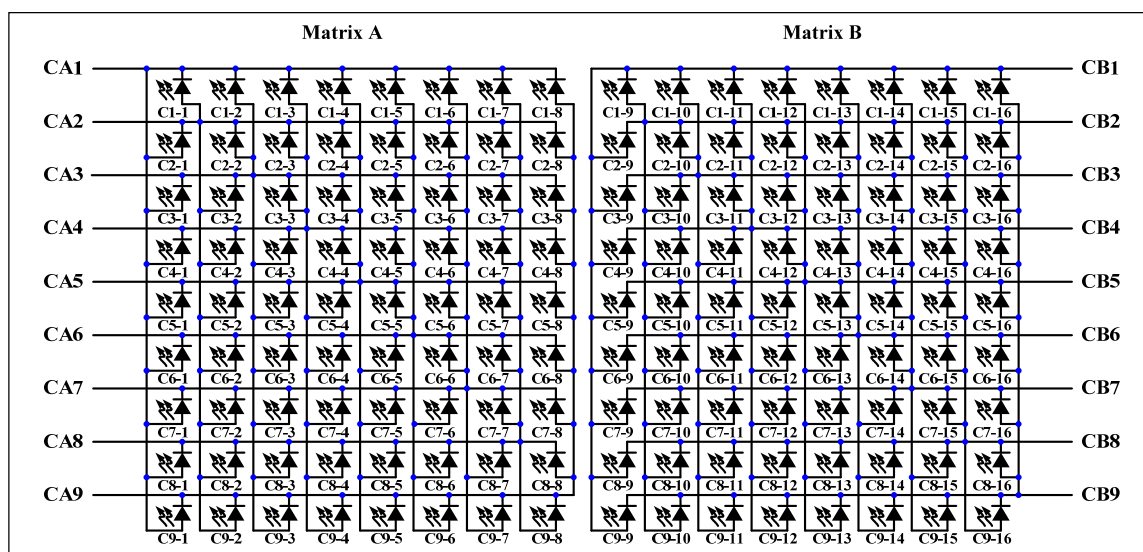

Figure 8 LED array

IS31FL3731

FUNCTION REGISTER

Table 8 00h Configuration Register

Bit	D7:D5	D4:D3	D2:D0
Name	-	MODE	FS
Default	000	00	000

The Configuration Register sets operating mode of IS31FL3731.

MODE	Display Mode
00	Picture Mode
01	Auto Frame Play Mode
1x	Audio Frame Play Mode

FS	Frame Start
(Available in Auto Frame Play Mode)	
000	Frame 1
001	Frame 2
010	Frame 3
011	Frame 4
100	Frame 5
101	Frame 6
110	Frame 7
111	Frame 8

FS bit sets the start frame in Auto Frame Play Mode. Movie starts from Frame 4 when the FS bit is set to "011". The FS bit is only available in Auto Frame Play Mode.

Table 9 01h Picture Display Register

Bit	D7:D3	D2:D0
Name	-	PFS
Default	00000	000

The Picture Display Register sets display frame in Picture Mode.

PFS	Picture Frame Selection
(Available in Picture Mode)	
000	Frame 1
001	Frame 2
010	Frame 3
011	Frame 4
100	Frame 5
101	Frame 6
110	Frame 7
111	Frame 8

Table 10 02h Auto Play Control Register 1

Bit	D7	D6:D4	D3	D2:D0
Name	-	CNS	-	FNS
Default	0	000	0	000

The Auto Play Control Register 1 sets the way of display in Auto Frame Play Mode.

CNS	Number of Loops Playing Selection
(Available in Auto Frame Play Mode)	
000	Play endless
001	1 loop
010	2 loops
011	3 loops
100	4 loops
101	5 loops
110	6 loops
111	7 loops

FNS	Number of Frames Playing Selection
(Available in Auto Frame Play Mode)	
000	All Frame
001	1 frame
010	2 frames
011	3 frames
100	4 frames
101	5 frames
110	6 frames
111	7 frames

Movie will be stop in the next frame of the cycle. For example, FS bit is set to "011", CNS bit is set to "011" and FNS bit is set to "011". Then the movie will play from frame 4 to frame 6 and play three times it stops in frame 7.

Table 11 03h Auto Play Control Register 2

Bit	D7:D6	D5:D0
Name	-	A
Default	00	000000

The Auto Play Control Register 2 sets the delay time in Auto Frame Play Mode (Figure 12).

FDT	Frame Delay Time
(Available in Auto Frame Play Mode)	
If A = 0, FDT = $\tau \times 64$;	
If A = 1~63, FDT = $\tau \times A$;	
A = 0~63 and $\tau = 11\text{ms}$ (Typ.);	
For example, when A = 23, FDT is $11\text{ms} \times 23 = 253\text{ms}$	

IS31FL3731

Table 12 05h Display Option Register

Bit	D7:D6	D5	D4	D3	D2:D0
Name	-	IC	-	BE	A
Default	00	0	0	0	000

The Display Option Register sets display option of IS31FL3731.

IC Intensity Control
 0 Set the intensity of each frame independently
 1 Use intensity setting of frame 1 for all other frames

BE Blink Enable
 0 Disable
 1 Enable

BPT Blink Period Time
 $BPT = \tau \times A$;
 $A = 0 \sim 7, \tau = 0.27s$ (Typ.);
 For example, when $A = 5$, BPT is $0.27s \times 5 = 1.35s$.

The duty cycle for blink function is 50%.

Table 13 06h Audio Synchronization Register

Bit	D7:D1	D0
Name	-	AE
Default	0000000	0

The Audio Synchronization Register sets audio synchronization function.

AE Audio Synchronization Enable
 0 Audio synchronization disable
 1 Enable audio signal to modulate the intensity of the matrix

The intensity of matrix can be modulated by the audio input signal basing on each LED's current is set by PWM when the AE bit is set to "1".

Table 14 07h Frame State Register (Read Only)

Bit	D7:D5	D4	D3	D2:D0
Name	-	INT	-	CFD
Default	-			

The Frame State Register stores the frame display information.

INT Interrupt Bit
 (Available in Auto Frame Play Mode)
 0 Movie does not finish
 1 Movie has finished

CFD Current Frame Display
 000 Frame 1
 001 Frame 2
 010 Frame 3
 011 Frame 4
 100 Frame 5
 101 Frame 6
 110 Frame 7
 111 Frame 8

The INT bit will be set to "1" automatically when movie is end in Auto Frame Play Mode. The INT bit can be cleared up by reading the Frame State Register.

Table 15 08h Breath Control Register 1

Bit	D7	D6:D4	D3	D2:D0
Name	-	A	-	B
Default	0	000	0	000

The Breath Control Register 1 sets fade in and fade out time for breath function.

FOT Fade Out Time
 $FOT = \tau \times 2^A$
 $A = 0 \sim 7, \tau = 26ms$ (Typ.)
 For example, when $A = 4$, FOT is $26ms \times 2^4 = 416ms$

FIT Fade In Time
 $FIT = \tau \times 2^B$
 $B = 0 \sim 7, \tau = 26ms$ (Typ.)
 For example, when $A = 4$, FIT is $26ms \times 2^4 = 416ms$

IS31FL3731

Table 16 09h Breath Control Register 2

Bit	D7:D5	D4	D3	D2:D0
Name	-	B_EN	-	A
Default	000	0	0	000

The Breath Control Register 2 sets the breath function.

B_EN Breath Enable
(Available in Picture Mode and Auto Frame Play Mode)
0 Disable
1 Enable

ET Extinguish Time
 $ET = \tau \times 2^A$
A = 0~7, $\tau = 3.5\text{ms}$ (Typ.)
For example, when A = 4, ET is $3.5\text{ms} \times 2^4 = 56\text{ms}$

Table 17 0Ah Shutdown Register

Bit	D7:D1	D0
Name	-	SSD
Default	0000000	0

The Shutdown Register sets software shutdown mode.

SSD Shutdown Control
0 Shutdown Mode
1 Normal Operation

Table 18 0Bh AGC Control Register

Bit	D7:D5	D4	D3	D2:D0
Name	-	AGCM	AGC	AGS
Default	000	0	0	000

The AGC Control Register sets the AGC function and the audio gain.

AGCM AGC Mode
0 Slow Mode
1 Fast Mode

AGC AGC Enable
0 Disable
1 Enable

AGS Audio Gain Selection

000	0dB
001	3dB
010	6dB
011	9dB
100	12dB
101	15dB
110	18dB
111	21dB

The AGS bit is available in Audio Frame Play Mode and audio synchronization mode.

Table 19 0Ch Audio ADC Rate Register

Bit	D7:D0
Name	A
Default	0000 0000

The Audio ADC Rate Register sets the ADC sample rate of the input signal in Audio Frame Play Mode.

AAR Audio ADC Rate
(Available in Audio Frame Play Mode)
If A = 0, $AAR = \tau \times 256$
If A = 1~255, $AAR = \tau \times A$
 $\tau = 46\mu\text{s}$ (Typ.)
For example, when A = 14, AAR is $46\mu\text{s} \times 14 = 644\mu\text{s}$

IS31FL3731

FUNCTIONAL BLOCK DIAGRAM

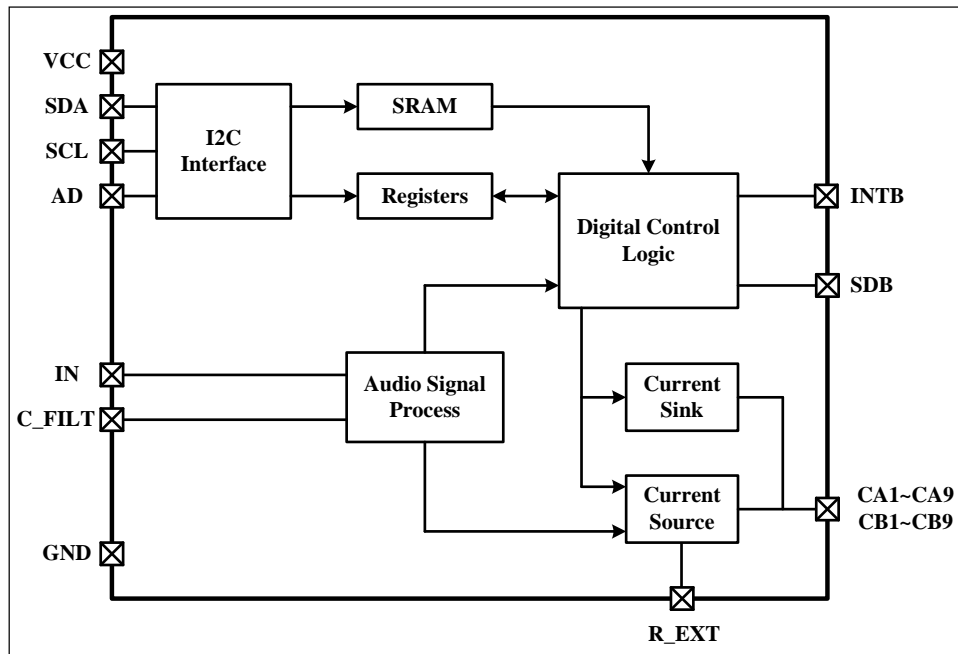

IS31FL3731

APPLICATION INFORMATION (The description below is for the Function Register unless otherwise noted.)

PWM CONTROL

The brightness of 144 LEDs can be modulated with 256 steps by PWM Register. For example, if the data in PWM Register is “0000 0100”, then the PWM is the fourth step.

Writing new data continuously to the registers can modulate the brightness of the LEDs to achieve a breathing effect.

GAMMA CORRECTION

In order to perform a better visual LED breathing effect we recommend using a gamma corrected PWM value to set the LED intensity. This results in a reduced number of steps for the LED intensity setting, but causes the change in intensity to appear more linear to the human eye.

Gamma correction, also known as gamma compression or encoding, is used to encode linear luminance to match the non-linear characteristics of display. Since the IS31FL3731 can modulate the brightness of the LEDs with 256 steps, a gamma correction function can be applied when computing each subsequent LED intensity setting such that the changes in brightness matches the human eye's brightness curve.

Table 17 32 gamma steps with 256 PWM steps

C(0)	C(1)	C(2)	C(3)	C(4)	C(5)	C(6)	C(7)
0	1	2	4	6	10	13	18
C(8)	C(9)	C(10)	C(11)	C(12)	C(13)	C(14)	C(15)
22	28	33	39	46	53	61	69
C(16)	C(17)	C(18)	C(19)	C(20)	C(21)	C(22)	C(23)
78	86	96	106	116	126	138	149
C(24)	C(25)	C(26)	C(27)	C(28)	C(29)	C(30)	C(31)
161	173	186	199	212	226	240	255

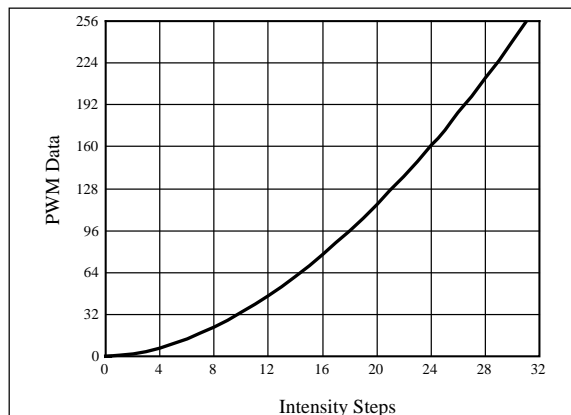

Figure 9 Gamma Correction(32 Steps)

Choosing more gamma steps provides for a more continuous looking breathing effect. This is useful for very long breathing cycles. The recommended

configuration is defined by the breath cycle T. When T=1s, choose 32 gamma steps, when T=2s, choose 64 gamma steps. The user must decide the final number of gamma steps not only by the LED itself, but also based on the visual performance of the finished product.

Table 18 64 gamma steps with 256 PWM steps

C(0)	C(1)	C(2)	C(3)	C(4)	C(5)	C(6)	C(7)
0	1	2	3	4	5	6	7
C(8)	C(9)	C(10)	C(11)	C(12)	C(13)	C(14)	C(15)
8	10	12	14	16	18	20	22
C(16)	C(17)	C(18)	C(19)	C(20)	C(21)	C(22)	C(23)
24	26	29	32	35	38	41	44
C(24)	C(25)	C(26)	C(27)	C(28)	C(29)	C(30)	C(31)
47	50	53	57	61	65	69	73
C(32)	C(33)	C(34)	C(35)	C(36)	C(37)	C(38)	C(39)
77	81	85	89	94	99	104	109
C(40)	C(41)	C(42)	C(43)	C(44)	C(45)	C(46)	C(47)
114	119	124	129	134	140	146	152
C(48)	C(49)	C(50)	C(51)	C(52)	C(53)	C(54)	C(55)
158	164	170	176	182	188	195	202
C(56)	C(57)	C(58)	C(59)	C(60)	C(61)	C(62)	C(63)
209	216	223	230	237	244	251	255

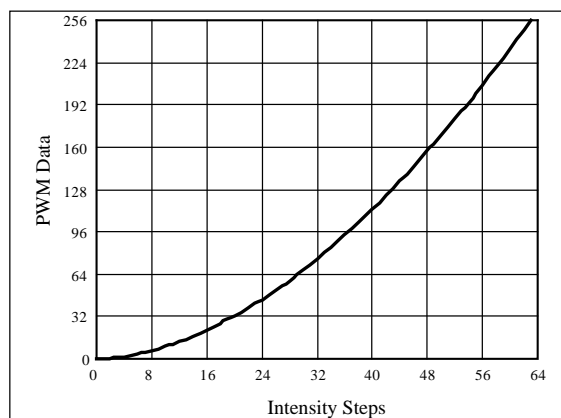

Figure 10 Gamma Correction(64 Steps)

Note: The data of 32 gamma steps is the standard value and the data of 64 gamma steps is the recommended value.

OPERATING MODE

IS31FL3731 has three operating modes, Picture Mode, Auto Frame Play Mode and Audio Frame Play Mode.

PICTURE MODE

By setting the MODE bit of the Configuration Register (00h) to “00”, the IS31FL3731 operates in Picture Mode. Set the PFS bit of Picture Display Register (01h) to choose the display frame. The Picture Mode

IS31FL3731

can be operating with breath function by configuring Breath Control Register 2 (09h).

AUTO FRAME PLAY MODE

By setting the MODE bit of the Configuration Register (00h) to "01", the IS31FL3731 operates in Auto Frame Play Mode. It stores data of 8 frames and automatically plays in order. Customers can configure the delay time between each two frames and the first playing frame by setting the FS bit of Configuration Register (00h). The Auto Play Control Register 1 (02h) can configure the display cycle and display frames.

Configure the Auto Play Control Register 2 (03h), Breath Control Register 1 (08h) and Breath Control Register 2 (09h) can set the breath time between two frames switching.

AUDIO FRAME PLAY MODE

By setting the MODE bit of the Configuration Register (00h) to "1x", the IS31FL3731 operates in Audio Frame Play Mode. It stores data of 8 frames and the 8 frames playing follow the input signal. 0Ch register is used to set the ADC sample rate for the input signal to control frames playing. It plays the first frame when the value is the smallest and plays the eighth frame when the value is the biggest.

AUDIO MODULATED AND GAIN SETTING

By setting the AE bit of the Audio Synchronization Register (06h) to "1", IS31FL3731 operates with audio synchronization. The intensity of LEDs is adjusted by the input signal. The audio input gain can be set by the AGC Control Register (0Bh).

BLINK FUNCTION SETTING

By setting the BE bit of the Display Option Register (05h) to "1", blink function enable. If the BE bit is set to "1", each LED can be controlled by the Blink Control Registers (12h~23h in Page One to Page Eight). The Display Option Register (05h) is used to set the blink period time, BPT, and the duty cycle is 50% (Figure 11).

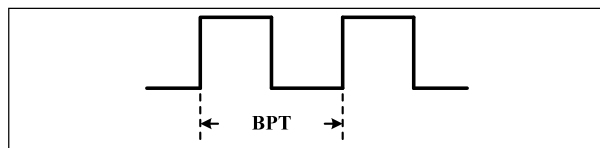

Figure 11 Blink function

BREATHING FUNCTION SETTING

When IS31FL3731 switches playing frame, breath function is available. By setting the B_EN bit of the Breath Control Register 2 (09h) to "1", breath function enable. When set the B_EN bit to "0", breath function disable.

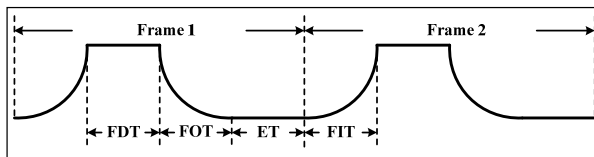

Figure 12 Breathing function

INTERRUPT CONTROL

When IS31FL3731 is playing frame in the Auto Frame Play Mode, the INTB pin is high and the INT bit of Frame State Register (07h) is "0". It will be pulled low as movie end and the INT bit will be set to "1" at the same time.

The INTB pin will come back to high level automatically if it stays low at least 7ms. The INT bit will reset to "0" only when reading the Frame State Register (07h).

LED MATRIX CIRCUIT

The IS31FL3731 can drive 144 LEDs totally. Part of LEDs can if there is no need to use all 144 LEDs (Figure 13). But the LEDs which are no connected must be off by LED Control Register (Frame Registers) or it will affect other LEDs.

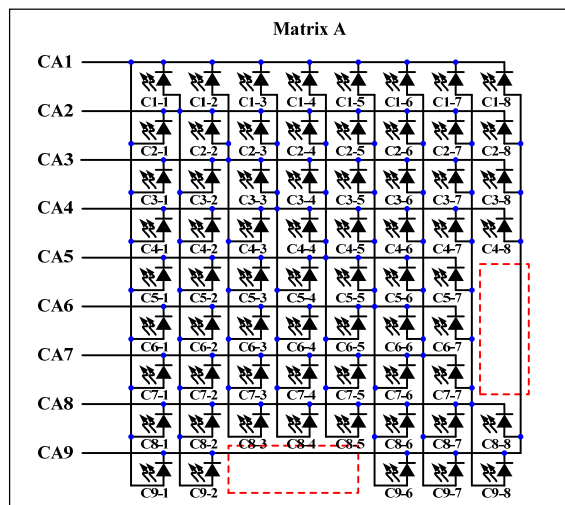

Figure 13 No C9-3~C9-5, C5-8~C9-8

IS31FL3731

MORE FRAMES DISPLAY

The IS31FL3731 can store 8 frames data at best. Each 4 frames writing in Frame Registers is recommended if there are more frames to play (Figure 14). First, store 8 frames data and play 4 frames in front. Then play last 4 frames and writing new data in the Frame Registers (1~4) at the same time. Play the new 4 frames (1~4) and write new data in the Frame Registers (5~8).

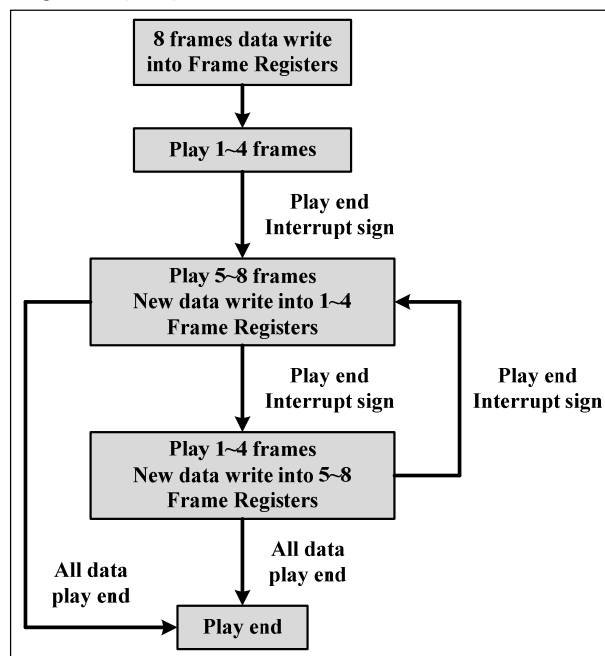

Figure 14 More frame data writing in

R_{EXT}

The average output current of each LED can be adjusted by the external resistor, R_{EXT}, as described in Formula (2).

$$I_{LED} = 64.7 / R_{EXT} \quad (2)$$

For example, in Figure 1, R_{EXT} = 20kΩ,

$$\text{So } I_{LED} = 64.7 / 20 = 3.2mA$$

The recommended minimum value of R_{EXT} is 18kΩ, or it may cause a large current.

SHUTDOWN MODE

Shutdown mode can be used as a means of reducing power consumption. During shutdown mode all registers retain their data.

SOFTWARE SHUTDOWN

By setting SSD bit of the Shutdown Register (0Ah) to "0", the IS31FL3731 will operate in software shutdown mode. When the IS31FL3731 is in software shutdown mode, all current sources and digital drivers are switched off, so that the matrix is blanked. All registers can be writing or read when the SDB pin is pulled high in software shutdown mode.

HARDWARE SHUTDOWN

The chip enters hardware shutdown mode when the SDB pin is pulled low. All registers are forbidden writing and reading.

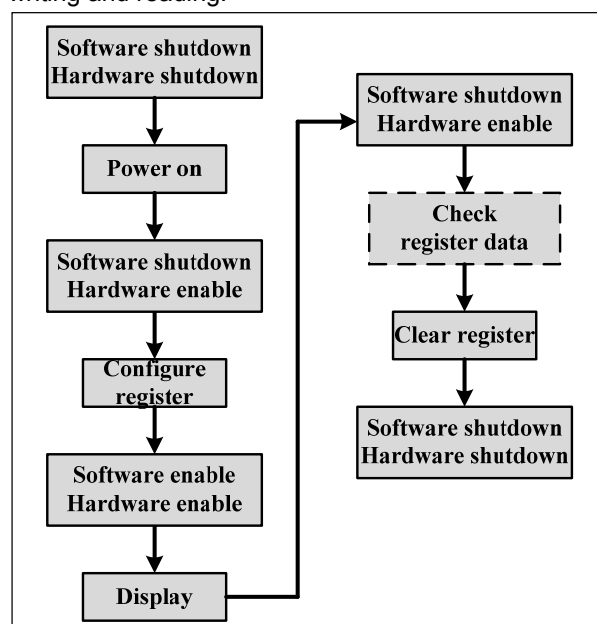
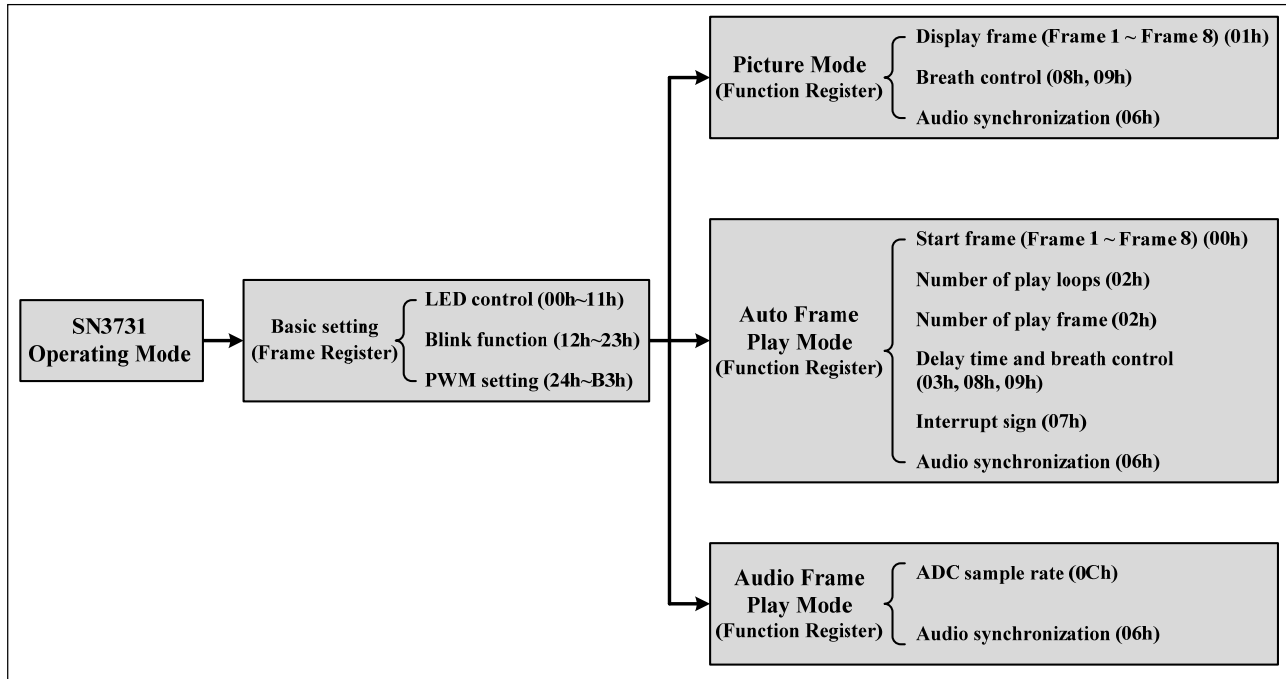

Figure 15 Shutdown Control



IS31FL3731

CLASSIFICATION REFLOW PROFILES

Profile Feature	Pb-Free Assembly
Preheat & Soak	
Temperature min (T _{smin})	150°C
Temperature max (T _{smax})	200°C
Time (T _{smin} to T _{smax}) (t _s)	60-120 seconds
Average ramp-up rate (T _{smax} to T _p)	3°C/second max.
Liquidous temperature (T _L)	217°C
Time at liquidous (t _L)	60-150 seconds
Peak package body temperature (T _p)*	Max 260°C
Time (t _p)** within 5°C of the specified classification temperature (T _c)	Max 30 seconds
Average ramp-down rate (T _p to T _{smax})	6°C/second max.
Time 25°C to peak	8 minutes max.

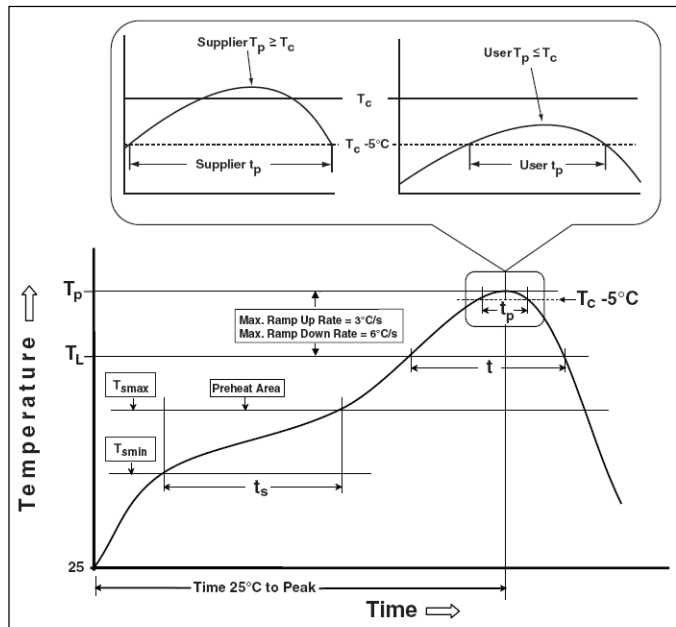
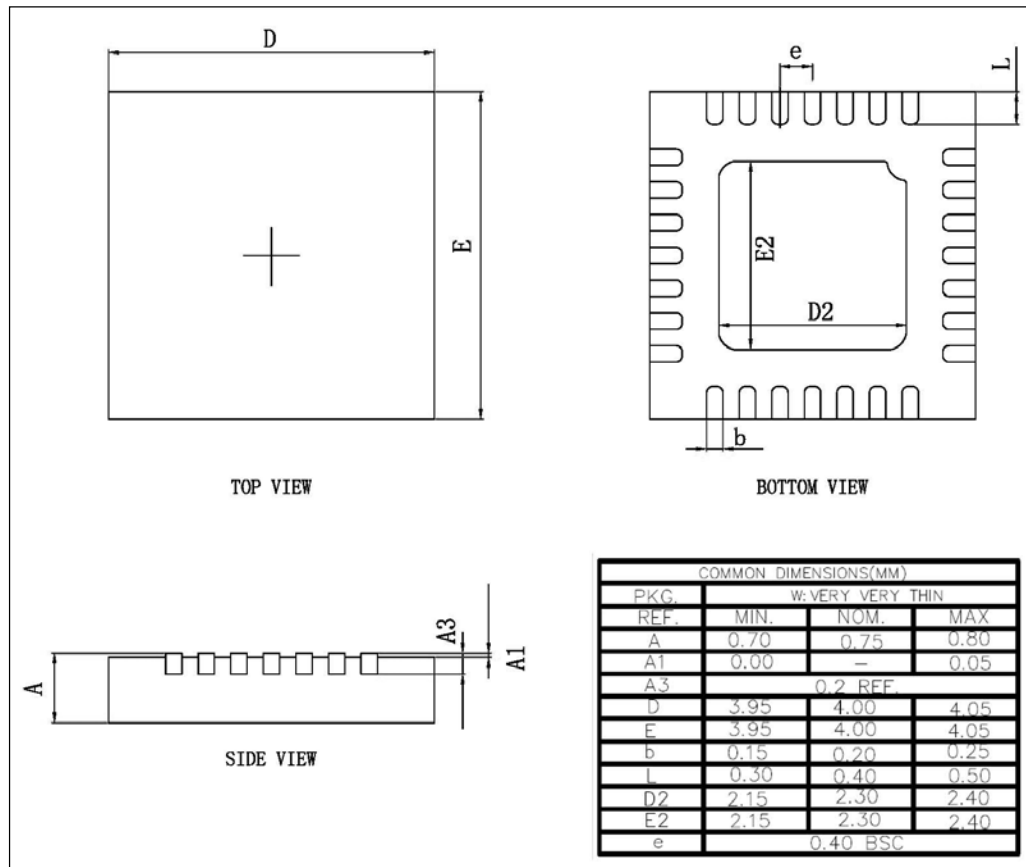

Figure 16 Classification Profile

IS31FL3731

PACKAGE INFORMATION

QFN-28



X-ON Electronics

Largest Supplier of Electrical and Electronic Components

Click to view similar products for [Adafruit Accessories](#) category:

Click to view products by [Adafruit](#) manufacturer:

Other Similar products are found below :

[3209](#) [3561](#) [3560](#) [3562](#) [2503](#) [3011](#) [3048](#) [2973](#) [2868](#) [2958](#) [2836](#) [2968](#) [3610](#) [3568](#) [3551](#) [2858](#) [3353](#) [3584](#) [3484](#) [2865](#) [3556](#) [3559](#) [3262](#)
[3348](#) [2499](#) [2878](#) [2963](#) [3219](#) [3005](#) [2882](#) [PGM1202](#) [02-LDR1](#) [02-LDR12](#) [02-LDR13](#) [02-LDR14](#) [02-LDR15](#) [02-LDR2](#) [02-LDR3](#) [02-LDR4](#)
[2194](#) [862](#) [460](#) [905](#) [02-LDR20](#) [02-LDR21](#) [02-LDR22](#) [02-LDR23](#) [1008](#) [1020](#) [1031](#)