

APPROVED: \_\_\_\_\_  
 DATE: \_\_\_\_\_ TITLE: \_\_\_\_\_

Rev	AWO #	Description	Date	Appr
-		RELEASED	6/6/18	
A		ADD O-RING SPEC.	04/27/20	TW
B		UPDATE TITLE SPEC. & DIM.	8/7/20	AY/RC
C		UPDATED DRAWING	5/4/22	JJ/KL

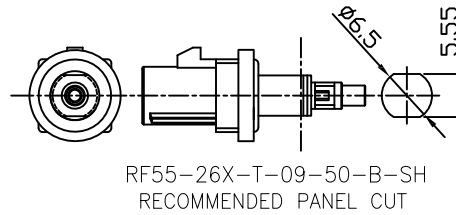

Type	Color	For Cable	Item No
A	BLACK	1.13/1.32 1.37mm Dia.	RF55-26A-T-09-50-X-SH
B	WHITE		RF55-26B-T-09-50-X-SH
C	BLUE		RF55-26C-T-09-50-X-SH
D	BORDEAUX VIOLET		RF55-26D-T-09-50-X-SH
E	GREEN		RF55-26E-T-09-50-X-SH
F	BROWN		RF55-26F-T-09-50-X-SH
G	GREY		RF55-26G-T-09-50-X-SH
H	VIOLET		RF55-26H-T-09-50-X-SH
I	BEIGE		RF55-26I-T-09-50-X-SH
K	CURRY		RF55-26K-T-09-50-X-SH
Z	WATER BLUE		RF55-26Z-T-09-50-X-SH
L	CARMINE RED		RF55-26L-T-09-50-X-SH
M	PASTEL ORANGE		RF55-26M-T-09-50-X-SH
N	PASTEL GREEN		RF55-26N-T-09-50-X-SH

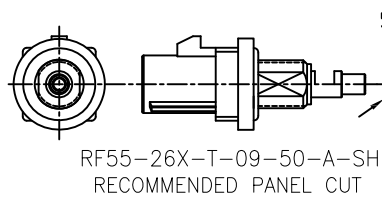
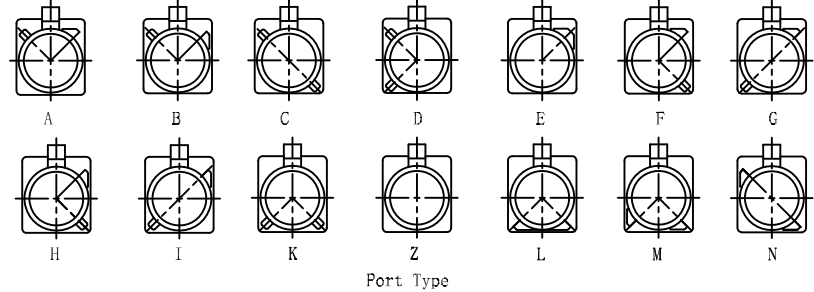
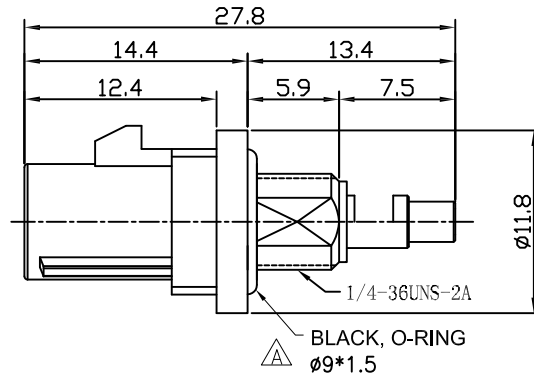
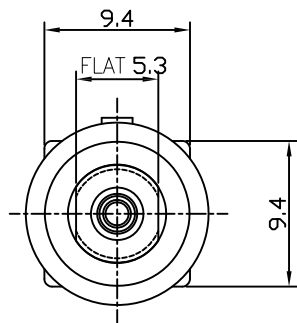
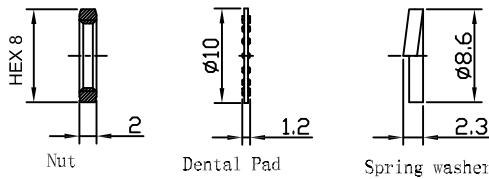

O-RING	BLACK SILICA GEL	
PLASTIC SHELL	PA66+30%GF	
COPPER TUBE	BRASS	NICKEL
INSULATOR	PTFE	
PIN CONTACT	BRASS	GOLD
BODY	BRASS	TRREE ELEMENT ALLOY
DESCRIPTION	MATERIAL	FINISH

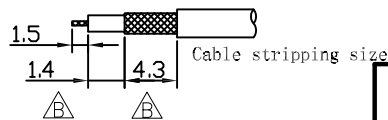

**SPECIFICATIONS:**  
 Electrical:  
 Frequency range: DC~6 GHz  
 Nominal Impedance: 50 ohms  
 Withstanding voltage: 335 V  
 Insulator Resistance: 1000 MΩ  
 Contact Resistance: 6 Milliohms max. (Center Contact)  
 1 Milliohms max. (Outer Contact)

Temperature Rating:  
 Operating temperature: -40°C to +85°C  
 Environmental:  
 Lead free, RoHS compliant.



See sht 2 for assembly instructions

UNLESS OTHERWISE SPECIFIED ALL DIMENSIONS ARE INCHES [MM]. TOLERANCES: EXCEPT AS NOTED

INCHES		HOLES	
.X	±.10	Ø.X	±.10
.XX	±.020	Ø.XX	±.015
.XXX	±.015	Ø.XXX	±.010

DRAWN	AY	6/6/18
CHECKED	MY	6/6/18
APPROVED		

THIS DRAWING CONTAINS INFORMATION THAT IS PROPRIETARY AND SHOULD NOT BE USED WITHOUT PRIOR WRITTEN PERMISSION FROM ADAM TECH



909 Rahway Avenue,  
 Union, NJ 07083  
 Phone: 908-687-5000  
 Fax: 908-687-5710

TITLE  
**FAKRA PLUG SMB TYPE STRAIGHT, BULKHEAD (IP67)**

SIZE X	PART NO. RF55-26X-T-09-50-X-SH	REV. C
REF: S00134C	SCALE: NTS	SHEET 1 OF 2

4

3

2

1

Rev

AWO #

Description

Date

Appr

SEE SHT 1 OF 2 FOR REVISION

## FAKRA connector cable assembly instructions

## STEP 1 PARTS NEEDED

A = Fakra Connector B = Metal Sleeve C = Heat Shrink Tubing  
(customer supplied)

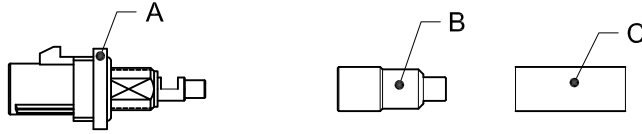

STEP 2 Strip Cable per below stripping lengths  
Conductor 1.5mm / Dielectric 1.2mm / Braid 3.2mm

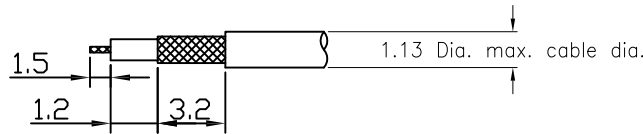

## STEP 3 Slide cable through metal sleeve "B" and heat shrink "C"

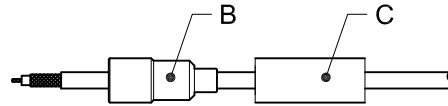

## STEP 4 Insert cable into back of connector and solder conductor

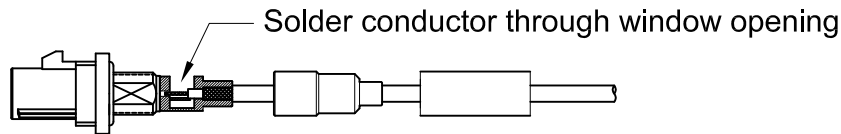

## STEP 5 Slide metal sleeve "B" over back of connector.

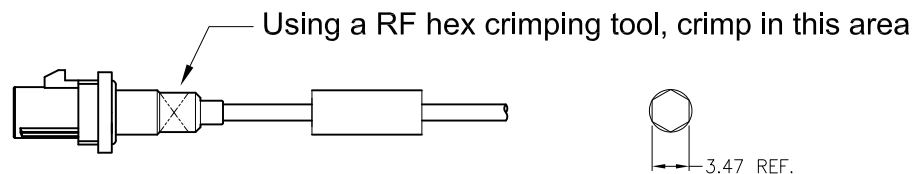

## STEP 6 Slide heat Shrink over back of connector and heat with heat gun

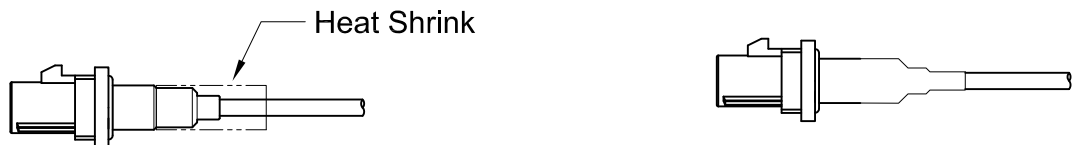

UNLESS OTHERWISE SPECIFIED ALL DIMENSIONS  
ARE INCHES [MM]. TOLERANCES: EXCEPT AS NOTED

INCHES		HOLES	
.X	± .10	∅X	± .10
.XX	± .020	∅XX	± .015
.XXX	± .015	∅XXX	± .010

**ADAM**  
**TECH**

909 Rahway Avenue,  
Union, NJ 07083  
Phone: 908-687-5000  
Fax: 908-687-5710

DRAWN	AY	6/6/18
CHECKED	MY	6/6/18
APPROVED		

TITLE  
FAKRA PLUG SMB TYPE STRAIGHT, BULKHEAD (IP67)

THIS DRAWING CONTAINS INFORMATION THAT IS PROPRIETARY  
AND SHOULD NOT BE USED WITHOUT PRIOR WRITTEN  
PERMISSION FROM ADAM TECH

SIZE	PART NO.	REV.
X	RF55-26X-T-09-50-X-SH	C

REF: S00134C	SCALE: NTS	SHEET 2 OF 2
--------------	------------	--------------

4

3

2

1

## X-ON Electronics

Largest Supplier of Electrical and Electronic Components

*Click to view similar products for [RF Connectors / Coaxial Connectors](#) category:*

*Click to view products by [Adam](#) manufacturer:*

Other Similar products are found below :

[89674-0827](#) [6059674-1](#) [630059-000](#) [6501-1071-002](#) [6769](#) [7002-1541-010](#) [7002-1572-002](#) [7004-1512-000](#) [7009-1511-004](#) [7101-1541-010](#)  
[7101-1571-002](#) [7105-1521-002](#) [7203-1571-003](#) [7209-1511-011](#) [7210-1511-040](#) [7242-1511-000](#) [7405-1521-005](#) [7405-1521-802](#)  
[804S01D04M040](#) [8527](#) [8547](#) [FS11V](#) [877931](#) [8808-1511-001](#) [9049-9513-000](#) [9074-9513-000](#) [PL11C-026](#) [PL40-36](#) [9408-1113-000](#) [980-](#)  
[8666-005](#) [11 SMA-50-2-6 / 111 NE](#) [11 SMA-50-3-6 / 111 NE](#) [1-201144-1](#) [120919](#) [R107003010W](#) [R112186000](#) [R113053000W](#) [R113082097](#)  
[R113236000](#) [R114083000](#) [R114670000W](#) [R123415000W](#) [R124076320](#) [R124076450](#) [R124175123](#) [R125075000W](#) [R125075001](#)  
[R125172000W](#) [R125415030](#) [R141007161](#)