

APPROVED: _____
 DATE: _____ TITLE: _____

Rev	AWO #	Description	Date	Appr
-		RELEASED	3/22/18	
A		UPDATED DRAWING	7/27/18	HR/YC

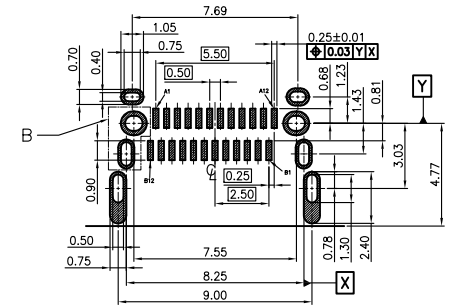

RECOMMEND P.C.B LAYOUT (COMPONENT SIDE)
 TOLERANCE FOR PCB LAYOUT IS ±0.05
 PAD AREA

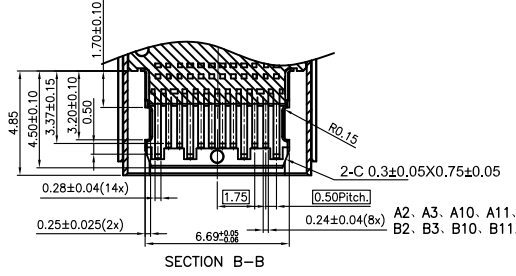
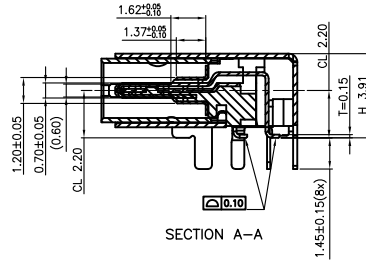
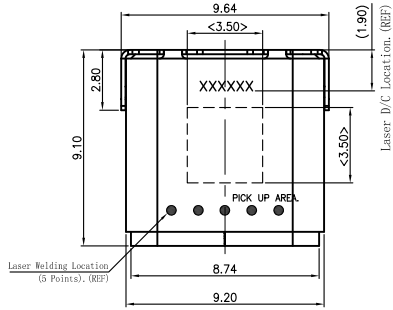
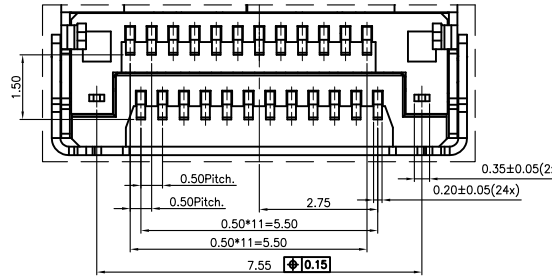
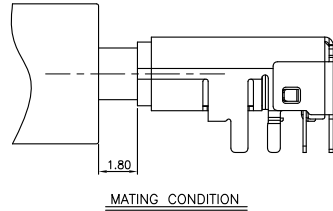
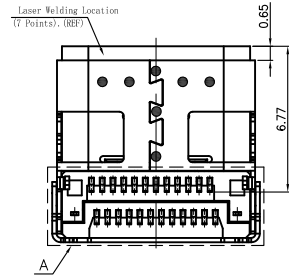
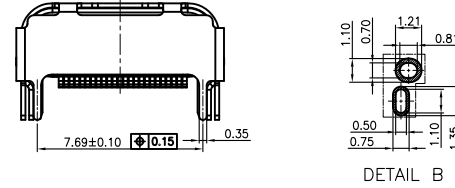
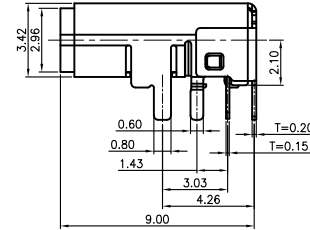
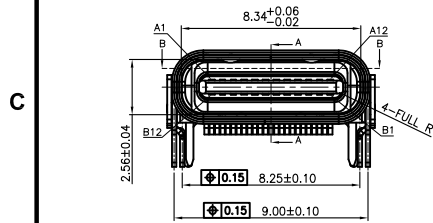

Detail A
 SC 2:1

Pin	Signal Name	Mating Sequence	Pin	Signal Name	Mating Sequence
A1	GND	First	B12	GND	First
A2	SSTxp1	Second	B11	SSRxp1	Second
A3	SSTxn1	Second	B10	SSRxn1	Second
A4	V _{BUS}	First	B9	V _{BUS}	First
A5	CC1	Second	B8	SBU2	Second
A6	Dp1	Second	B7	Dn2	Second
A7	Dn1	Second	B6	Dp2	Second
A8	SBU1	Second	B5	CC2	Second
A9	V _{BUS}	First	B4	V _{BUS}	First
A10	SSRxn2	Second	B3	SSTxn2	Second
A11	SSRxp2	Second	B2	SSTxp2	Second
A12	GND	First	B1	GND	First
SHELL	GND		SHELL	GND	

SPECIFICATIONS:

Material:
 Insulator: Hi-temp thermoplastic, rated UL 94V-0
 Insulator color: Black
 Contacts: Copper Alloy
 Shell: Stainless Steel, Nickel plated
 Plating:
 Gold flash over Nickel underplate on Contact area
 Matte Tin over Nickel underplate on Solder tails

Electrical:
 Current rating: 5 A (Power supply pin: A1, A4, A9, A12, B1, B4, B9, B12)
 1.25 A (Vconn pin)
 0.25 A (Other signal pin)

Contact resistance: 40 mohms max @ 20mV, 100 mA
 Insulation resistance: 100 Mohms min.
 Dielectric withstanding: 100 VAC RMS

Mechanical:
 Insertion force: 5~20N
 Withdrawal force: 6~20N After test
 Durability: 10,000 Cycles

Temperature Rating:
 Operating temperature: -40°C to +85°C
Environmental:
 Lead free, RoHS compliant.



PACKAGED ON TAPE & REEL

UNLESS OTHERWISE SPECIFIED ALL DIMENSIONS ARE MILLIMETERS TOLERANCES: EXCEPT AS NOTED	
MM	ANGEL
X. ± 0.50	± 2°
X.X ± 0.25	
X.XX ± 0.20	
X.XXX ± 0.10	
APPROVALS	
DRAWN	DATE
CHECKED	3/22/18
APPROVED	AC
	3/22/18

ADAM TECH INTERCONNECTS
 909 Rahway Avenue,
 Union, NJ 07083
 Phone: 908-687-5000
 Fax: 908-687-5710

TITLE UNIVERSAL SERIAL BUS, TYPE C, FEMALE, RIGHT ANGLE, BLACK, TAPE & REEL			
SIZE X	PART NO. USB-C31-S-RA-CS2-SMT-BK-T/R	REV. A	
REF: S00296T	SCALE: NTS	SHEET 1 OF 1	

X-ON Electronics

Largest Supplier of Electrical and Electronic Components

Click to view similar products for [USB Connectors](#) category:

Click to view products by [Adam](#) manufacturer:

Other Similar products are found below :

[950](#) [A-USB A-LP-SMT-C](#) [A-USB B-TOP-C](#) [MUSBD11135](#) [17-200721](#) [217450-1](#) [KMBVX-TH-5S-B30](#) [KUSBX-AS2N-W](#) [KUSBX-SMT2AP1S-W30](#) [935](#) [957](#) [30-498-6](#) [SK-60A-2](#) [1734082-1](#) [30-470](#) [30-489](#) [30-541](#) [MIKROE-1451](#) [USBFTVSCCG](#) [1-1734084-2](#)
[10135326-001LF](#) [USB3FTV7APEG](#) [4198](#) [1310-1023-02](#) [690-024-633-031](#) [UB-20PMFP-LC7001](#) [17-200011](#) [UB-20AFMM-LL7A01](#)
[1040870124](#) [CAP-WCCMLPB1](#) [2274475-3](#) [UB-20BMFA-SL8001](#) [UB-20BFM-SA7A02](#) [UB-20BFM-SA7A05](#) [914-614A2025S10200](#)
[MUSBR-AHD2-M41-SK](#) [ZX40-B-5S-1500-STDA\(30\)](#) [GSB3116344HR](#) [USB3FTV2SAZNF459](#) [USBF21GSCC](#) [U221-041N-1WVS62-F5D](#)
[HYCW153-USBD05-500B](#) [HYCW219-USBD05-075B](#) [HYCW148-USBD05-117B](#) [HYCW149-USBD05-740B](#) [HYCW204-USBD05-108B](#)
[HYCW214-USBA04-113B](#) [HYCW213-USBA04-113B](#) [UB-20AMFM-SL7A01](#) [KMMX-BSMT35S-1-B30TR](#)